

MASTERFORCE®

4-1/2" ANGLE GRINDER WITH PADDLE SWITCH

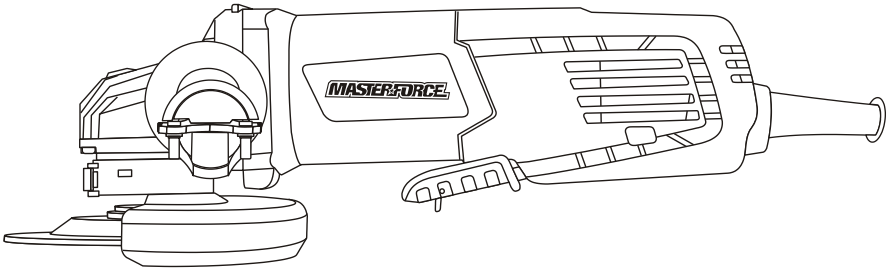

241-0785

For questions/comments, technical assistance or repair parts –
Please call toll free: 1-866-349-8665 (M–F 9am–5pm EST)

OPERATOR'S MANUAL

⚠ CAUTION: To Reduce The Risk Of Injury, User Must Read And Understand Operator's Manual. Save These Instructions For Future Reference.

TABLE OF CONTENTS

Front cover	1
Table of contents	2
General safety warnings	3-4
Eye, ear & lung protection	3-4
Electrical safety	4
Power tool safety	5-6
General safety rules	5
Work area safety	5
Electrical safety	5
Personal safety	5-6
Power tool use and care	6
Service	6
Specific safety rules	7-10
Extension cord safety	10
Product specifications	11
Symbols	12
Know your angle grinder	13
Accessories	13
Assembly and operating	14-17
Installing the auxiliary handle	14
Installing the guard	14
Positioning the guard	14
Changing a grinding disc	15
ON/OFF switch and lock-on button	16
Grinding	16-17
Maintenance	17-19
General maintenance	17
Service	17
Removing motor brushes	18
Installing new motor brushes	19
Exploded view	20
Parts list	21-22
Notes	23
Warranty	24
Back cover	25

GENERAL SAFETY WARNINGS



WARNING: Before using this tool or any of its accessories, read this manual and follow all Safety Rules and Operating Instructions. The important precautions, safeguards and instructions appearing in this manual are not meant to cover all possible situations. It must be understood that common sense and caution are factors which cannot be built into the product.

This instruction manual includes the following:

- General Safety Rules
- Specific Safety Rules and Symbols
- Functional Description
- Assembly
- Operation
- Maintenance
- Accessories

EYE, EAR & LUNG PROTECTION



ALWAYS WEAR EYE PROTECTION THAT CONFORMS WITH CSA REQUIREMENTS or ANSI SAFETY STANDARD Z87.1

FLYING DEBRIS can cause permanent eye damage. Prescription eyeglasses ARE NOT a replacement for proper eye protection.



WARNING: Non-compliant eyewear can cause serious injury if broken during the operation of a power tool.



WARNING: Use hearing protection, particularly during extended periods of operation of the tool, or if the operation is noisy.

SAVE THESE INSTRUCTIONS FOR REFERENCE

GENERAL SAFETY WARNINGS



WEAR A DUST MASK THAT IS DESIGNED TO BE USED WHEN OPERATING A POWER TOOL IN A DUSTY ENVIRONMENT.



WARNING: Dust that is created by power sanding, sawing, grinding, drilling, and other construction activities may contain chemicals that are known to cause cancer, birth defects, or other genetic abnormalities. These chemicals include:

Lead from lead-based paints
Crystalline silica from bricks, cement, and other masonry products
Arsenic and chromium from chemically treated lumber

The level of risk from exposure to these chemicals varies, according to how often this type of work is performed. In order to reduce exposure to these chemicals, work in a well-ventilated area, and use approved safety equipment, such as a dust mask that is specifically designed to filter out microscopic particles.

ELECTRICAL SAFETY



WARNING: To avoid electrical hazards, fire hazards or damage to the tool, use proper circuit protection.

This tool is wired at the factory for 120V AC operation. It must be connected to a 120V AC, 15 A circuit that is protected by a time-delayed fuse or circuit breaker. To avoid shock or fire, replace power cord immediately if it is worn, cut or damaged in any way.

SAVE THESE INSTRUCTIONS FOR REFERENCE

POWER TOOL SAFETY

▲ WARNING: Read all safety warnings and instructions. Failure to follow the warnings and instructions may result in electric shock, fire and/or serious injury.

Save all warnings and instructions for future reference.

Work area safety

Keep work area clean and well lit. Cluttered or dark areas invite accidents.

Do not operate power tools in explosive atmospheres, such as in the presence of flammable liquids, gases or dust. Power tools create sparks which may ignite the dust or fumes.

Keep children and bystanders away while operating a power tool. Distractions can cause you to lose control.

Electrical safety

Power tool plugs must match the outlet. Never modify the plug in any way. Do not use any adapter plugs with earthed (grounded) power tools. Unmodified plugs and matching outlets will reduce risk of electric shock.

Avoid body contact with earthed or grounded surfaces such as pipes, radiators, ranges and refrigerators. There is an increased risk of electric shock if your body is earthed or grounded.

Do not expose power tools to rain or wet conditions. Water entering a power tool will increase the risk of electric shock.

Do not abuse the cord. Never use the cord for carrying, pulling or unplugging the power tool. Keep cord away from heat, oil, sharp edges or moving parts. Damaged or entangled cords increase the risk of electric shock.

When operating a power tool outdoors, use an extension cord suitable for outdoor use. Use of a cord suitable for outdoor use reduces the risk of electric shock.

If operating a power tool in a damp location is unavoidable, use a residual current device (RCD) protected supply. Use of a ground fault circuit interrupter (GFCI) reduces the risk of electric shock.

Personal safety

Stay alert, watch what you are doing and use common sense when operating a power tool. Do not use a power tool while you are tired or under the influence of drugs, alcohol or medication. A moment of inattention while operating power tools may result in serious personal injury.

Use personal protective equipment. Always wear eye protection. Protective equipment such as dust mask, non-skid safety shoes, hard hat, or hearing protection used for appropriate conditions will reduce personal injuries.

Prevent unintentional starting. Ensure the switch is in the off-position before connecting to power source and/or battery pack, picking up or carrying the tool. Carrying power tools with your finger on the switch or energizing power tools that have the switch on invites accidents.

Remove any adjusting key or wrench before turning the power tool on. A wrench or a key left attached to a rotating part of the power tool may result in personal injury.

Do not overreach. Keep proper footing and balance at all times. This enables better control of the power tool in unexpected situations.

SAVE THESE INSTRUCTIONS FOR REFERENCE

POWER TOOL SAFETY

Dress properly. Do not wear loose clothing or jewelry. Keep your hair, clothing and gloves away from moving parts. Loose clothes, jewelry or long hair can be caught in moving parts.

If devices are provided for the connection of dust extraction and collection facilities, ensure these are connected and properly used. Use of dust collection can reduce dust-related hazards.

Power tool use and care

Do not force the power tool. Use the correct power tool for your application. The correct power tool will do the job better and safer at the rate for which it was designed.

Do not use the power tool if the switch does not turn it on and off. Any power tool that cannot be controlled with the switch is dangerous and must be repaired.

Disconnect the plug from the power source and/or the battery pack from the power tool before making any adjustments, changing accessories, or storing power tools. Such preventive safety measures reduce the risk of starting the power tool accidentally.

Store idle power tools out of the reach of children and do not allow persons unfamiliar with the power tool or these instructions to operate the power tool. Power tools are dangerous in the hands of untrained users.

Maintain power tools. Check for misalignment or binding of moving parts, breakage of parts and any other condition that may affect the power tool's operation. If damaged, have the power tool repaired before use. Many accidents are caused by poorly maintained power tools.

Keep cutting tools sharp and clean. Properly maintained cutting tools with sharp cutting edges are less likely to bind and are easier to control.

Use the power tool, accessories and tool bits etc. in accordance with these instructions, taking into account the working conditions and the work to be performed. Use of the power tool for operations different from those intended could result in a hazardous situation.

Service

Have your power tool serviced by a qualified repair person using only identical replacement parts. This will ensure that the safety of the power tool is maintained.

SAVE THESE INSTRUCTIONS FOR REFERENCE

SPECIFIC SAFETY RULES

▲ WARNING: Know your angle grinder. Do not plug the angle grinder into the power source until you have read and understand this Instruction Manual. Learn the tool's applications and limitations, as well as the specific potential hazards related to this tool. Following this rule will reduce the risk of electric shock, fire, or serious injury.



Always wear eye protection. Any power tool can throw foreign objects into your eyes and cause permanent eye damage.

ALWAYS wear safety goggles (not glasses) that comply with ANSI safety standard Z87.1. Everyday glasses have only impact resistant lenses. They ARE NOT safety glasses.

▲ WARNING: Glasses or goggles not in compliance with ANSI Z87.1 could cause serious injury when they break.

This power tool is intended to function as a grinder. For other applications, see UL Standard 60745-2-3 Pages 7, 8 and 9. Read all safety warnings, instructions, illustrations and specifications provided with this power tool. Failure to follow all instructions listed below may result in electric shock, fire and/or serious injury.

Do not use accessories which are not specifically designed and recommended by the tool manufacturer. Just because the accessory can be attached to your power tool, it does not assure safe operation.

The rated speed of the accessory must be at least equal to the maximum speed marked on the power tool. Accessories running faster than their RATED SPEED can break and fly apart.

The outside diameter and the thickness of your accessory must be within the capacity rating of your angle grinder. Incorrectly sized accessories cannot be adequately guarded or controlled.

Always follow the instructions related to the use of blotters, correct use of flanges and guards, and proper storage of the accessory outlined by the manufacturer of the accessory.

The arbor size of wheels, flanges, backing pads or any other accessory must properly fit the spindle of the angle grinder tool. Accessories with arbor holes that do not match the mounting hardware of the angle grinder will run out of balance, vibrate excessively and may cause loss of control.

Do not use a damaged accessory. Before each use inspect the accessory for chips and cracks. If the angle grinder or accessory is dropped, inspect them for damage or install an undamaged accessory. After inspecting and installing the accessory, position yourself and bystanders away from the plane of the rotating accessory and run the power tool at maximum no-load speed for one minute. Damaged accessories will normally break apart during this test time.

Wear personal protective equipment. Depending on the application, use a face shield, safety goggles or safety glasses. As appropriate, wear a dust mask, hearing protectors, gloves and workshop apron capable of stopping small abrasive or workpiece fragments. The eye protection must be capable of stopping flying debris generated by various operations. The dust mask or respirator must be capable of filtering particles generated by your operation. Prolonged exposure to high intensity noise may cause hearing loss.

Keep bystanders a safe distance away from the work area. Anyone entering the work area must wear personal protective equipment. Fragments of the workpiece or of a broken accessory may fly away and cause injury beyond the immediate area of operation.

SAVE THESE INSTRUCTIONS FOR REFERENCE

SPECIFIC SAFETY RULES

Hold the angle grinder tool by insulated gripping surfaces only when performing an operation where the cutting accessory may contact hidden wiring or the angle grinder's cord. The cutting accessory contacting a "live" wire may make exposed metal parts of the angle grinder "live" and shock the operator.

Position the cord clear of the spinning accessory. If you lose control, the cord may be cut or snagged and your hand or arm may be pulled into the spinning accessory.

Never lay the angle grinder down until the accessory has come to a complete stop. The spinning accessory may grab the surface and pull the angle grinder out of your control.

Do not run the angle grinder while carrying it at your side. Accidental contact with the spinning accessory could snag your clothing, pulling the accessory into your body.

Regularly clean the angle grinder's air vents. The motor's fan will draw the dust inside the housing and excessive accumulation of powdered metal may cause electrical hazards.

Do not operate the angle grinder near flammable materials. Sparks could ignite these materials.

Do not use accessories that require liquid coolants. Using water or other liquid coolants may result in electrocution or shock.

Kickback and related warnings

Kickback is a sudden reaction to a pinched or snagged rotating wheel, backing pad, brush or any other accessory. Pinching or snagging causes rapid stalling of the rotating accessory which in turn causes the uncontrolled angle grinder to be forced in the direction opposite of the accessory's rotation at the point of the binding.

For example, if an abrasive wheel is snagged or pinched by the workpiece, the edge of the wheel that is entering into the pinch point can dig into the surface of the material causing the wheel to climb out or kick out.

The wheel may either jump toward or away from the operator, depending on direction of the wheel's movement at the point of pinching. Abrasive wheels may also break under these conditions.

Kickback is the result of power tool misuse and/or incorrect operating procedures or conditions and can be avoided by taking proper precautions as given below.

Maintain a firm grip on the angle grinder and position your body and arm to allow you to resist kickback forces. Always use the auxiliary handle for maximum control over kickback or torque reaction during start-up. The operator can control torque reactions or kickback forces if proper precautions are taken.

Never place your hand near the rotating accessory. The accessory may kickback over your hand.

Do not position your body in the area where the angle grinder will move if kickback occurs. Kickback will propel the tool in the direction opposite to the wheel's movement at the point of snagging.

Use special care when working corners, sharp edges etc. Avoid bouncing and snagging the accessory. Corners, sharp edges or bouncing have a tendency to snag the rotating accessory and cause loss of control or kickback.

Do not attach a saw chain woodcarving blade or toothed saw blade. Such blades create frequent kickback and loss of control.

Additional warnings for grinding

Use only wheel types that are recommended for your angle grinder and the specific guard designed for the selected wheel. Wheels for which the power tool was not designed cannot be adequately guarded and are unsafe.

SAVE THESE INSTRUCTIONS FOR REFERENCE

SPECIFIC SAFETY RULES

Additional warnings for grinding – cont'd

The guard must be securely attached to the angle grinder and positioned for maximum safety, so the least amount of wheel is exposed towards the operator. The guard helps to protect operator from broken wheel fragments and accidental contact with the wheel.

Wheels must be used only for recommended applications. For example: do not grind with the side of cut-off wheel. Abrasive cut-off wheels are intended for peripheral grinding and side forces applied to these wheels may cause them to shatter.

Always use undamaged wheel flanges that are of correct size and shape for your selected wheel. Proper wheel flanges support the wheel thus reducing the possibility of wheel breakage. Flanges for cut-off wheels may be different from grinding wheel flanges.

Do not use worn down wheels from larger power tools. Wheels intended for a larger angle grinder are not suitable for the higher speed of a smaller tool and may burst.

Additional safety warnings specific for abrasive cutting-off operations

Do not “jam” the cut-off wheel or apply excessive pressure. Do not attempt to make an excessive depth of cut. Overstressing the wheel increases the loading and susceptibility to twisting or binding of the wheel in the cut and the possibility of kickback or wheel breakage.

Do not position your body in line with and behind the rotating wheel. When the wheel, at the point of operation, is moving away from your body, the possible kickback may propel the spinning wheel and the power tool directly at you.

When wheel is binding or when interrupting a cut for any reason, switch off the power tool and hold the power tool motionless until the wheel comes to a complete stop.

Never attempt to remove the cut-off wheel from the cut while the wheel is in motion otherwise kickback may occur. Investigate and take corrective action to eliminate the cause of wheel binding.

Do not restart the cutting operation in the workpiece. Let the wheel reach full speed and carefully reenter the cut. The wheel may bind, walk up or kickback if the power tool is restarted in the workpiece.

Support panels or any oversized workpiece to minimize the risk of wheel pinching and kickback. Large workpieces tend to sag under their own weight. Supports must be placed under the workpiece near the line of cut and near the edge of the workpiece on both sides of the wheel.

Use extra caution when making a “pocket cut” into existing walls or other blind areas. The protruding wheel may cut gas or water pipes, electrical wiring or objects that can cause kickback.

Safety warnings specific for sanding operations

Do not use excessively oversized sanding disc paper. Follow manufacturer’s recommendations, when selecting sanding paper. Larger sanding paper extending beyond the sanding pad presents a laceration hazard and may cause snagging, tearing of the disc or kickback.

Safety warnings specific for polishing operations

Do not allow any loose portion of the polishing bonnet or its attachment strings to spin freely. Tuck away or trim any loose attachment strings. Loose and spinning attachment strings can entangle your fingers or snag on the workpiece.

SAVE THESE INSTRUCTIONS FOR REFERENCE

SPECIFIC SAFETY RULES

Safety warnings specific for wire brushing operations

Be aware that wire bristles are thrown by the brush even during ordinary operation. Do not overstress the wires by applying excessive load to the brush. The wire bristles can easily penetrate light clothing and/or skin.

If the use of a guard is recommended for wire brushing, do not allow any interference of the wire wheel or brush with the guard. Wire wheel or brush may expand in diameter due to work load and centrifugal forces.

Be sure your extension cord is properly wired and in good condition. Always replace a damaged extension cord or have it repaired by a qualified electrician before using it. Protect your extension cord from sharp objects, excessive heat and damp or wet areas.

Use a separate electrical circuit for your power tools. This circuit must not be less than 14 gauge wire and should be protected with either a 15 AMP time delayed fuse or circuit breaker. Before connecting the power tool to the power source, make sure the switch is in the OFF position and the power source is the same as indicated on the nameplate. Running at lower voltage will damage the motor.

EXTENSION CORD SAFETY

⚠ WARNING: Keep the extension cord clear of the working area. Position the cord so it will not get caught on the workpiece, tools or any other obstructions while you are working with the power tool.

Make sure any extension cord used with this tool is in good condition. When using an extension cord, be sure to use one of heavy enough gauge to carry the current the tool will draw. An undersized cord will cause a drop in line voltage resulting in loss of power and overheating.

The table at right shows the correct size to use according to cord length and nameplate ampere rating. If in doubt, use the next heavier gauge. The smaller the gauge number the heavier the cord.

MINIMUM GAUGE (AWG) EXTENSION CORDS (120V use only)					
Amperage rating		Total length			
More than	Not more than	25' (7.5 m)	50' (15 m)	100' (30 m)	150' (45 m)
0	6	18	16	16	14
6	10	18	16	14	12
10	12	16	16	14	12
12	16	14	12	Not Applicable	

SAVE THESE INSTRUCTIONS FOR REFERENCE

PRODUCT SPECIFICATIONS

Rating:	120V, 60Hz AC
Amperes:	10 AMP
Speed:	11,800 RPM (no load)
Maximum disc diameter:	4½" (115 mm)
Spindle threads:	5/8" – 11UNC (15.875 mm)
Minimum disc thickness:	5/32" (3.9 mm)
Weight:	10 lbs

Need Assistance?

Call us on our toll free customer support line:



1-866-349-8665 Monday – Friday from 9am to 5pm









Eastern Standard Time

- Technical questions
- Replacement parts
- Parts missing from package

SYMBOLS

▲ WARNING: Some of the following symbols may appear on the angle grinder. Study these symbols and learn their meaning. Proper interpretation of these symbols will allow for more efficient and safer operation of this tool.

V	Volts
A	Amperes
Hz	Hertz
W	Watts
kW	Kilowatts
μF	Microfarads
L	Liters
kg	Kilograms
H	Hours
N/cm²	Newtons per square centimeter
Pa	Pascals
OPM	Oscillations per minute
Min	Minutes
S	Seconds
 or a.c.	Alternating current
	Three-phase alternating current
	Three-phase alternating current with neutral

	Direct current
n₀	No load speed
	Alternating or direct current
	Class II construction
	Splash-proof construction
	Watertight construction
	Protective grounding at grounding terminal, Class I tools
.../min	Revolutions or reciprocations per minute
∅	Diameter
0	Off position
	Directional arrow
	Warning symbol
	Wear your safety glasses



This symbol designates that this tool is listed with U.S. requirements by ETL Testing Laboratories, Inc. Conforms to UL 60745-1, 60745-2-3. Certified to CAN/CSA STD C22.2 No. 60745-1, 60745-2-3.

KNOW YOUR ANGLE GRINDER

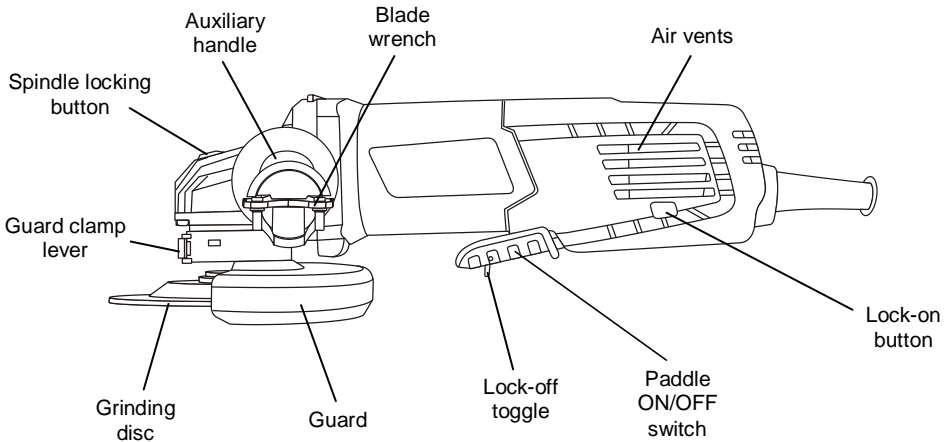

The following accessories may be used with this angle grinder. Only the grinding disc is supplied with this tool. Others must be purchased separately.

- 4½" grinding wheels
- 3" wire cup brushes
- 4" wire wheels
- 4½" abrasive cutting wheels
- 4½" diamond cutting wheels
- 4½" sanding discs
- 4½" sanding flap discs

⚠ WARNING: Accessories must be rated for at least 11,800 RPM. Grinding wheels and accessories rated below 11,800 RPM may explode causing serious injury. Every grinding wheel must have a 7/8" arbor hole and not exceed 4½" diameter. Accessories such as sanding discs, sanding flap discs and wire wheels must fit the 5/8" – 11 UNC threaded spindle. Never use a circular saw blade or a carving chain with this tool. They cannot be properly guarded and could cause serious injury.

ASSEMBLY AND OPERATING

⚠ WARNING: Always disconnect your angle grinder from the power source when replacing grinding or cut-off discs, adjusting the guard, cleaning the tool or when the tool is not in use. Disconnecting the angle grinder will prevent accidental starting that could cause serious personal injury.

INSTALLING THE AUXILIARY HANDLE

1. Unplug the angle grinder from the power source.
2. Install the auxiliary handle (1) by screwing it clockwise into the left side (2) of the gear housing (3) (Fig. 1).

NOTE: The handle can be installed in two different positions; left side or right side (Fig. 3 & 4).

⚠ WARNING: The auxiliary handle must always be used to prevent loss of control and possible injury.

3. Tighten the auxiliary handle securely.

NOTE: Hand tighten the auxiliary handle. Do not over tighten.

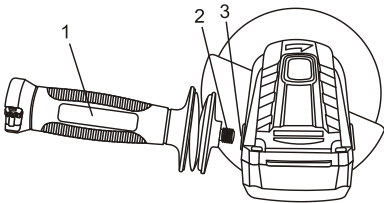

Fig. 1

INSTALLING THE GUARD

⚠ WARNING: The guard must be installed before installing a grinding disc or using the angle grinder. Failure to do so could result in serious personal injury.

1. Pull the guard clamp lever (1) outward to allow the guard clamp to expand for installation.

2. Slide the guard clamp (2) over the spindle housing (3) until the blade guard locating detents (4) mate with the grooves (5) in the spindle housing (Fig. 2).
3. Press the guard clamp fully onto the spindle housing.

NOTE: Rotate the guard so it is positioned correctly depending upon the location of the side handle in Fig. 3 & 4.

4. Push the guard clamp lever toward the guard clamp until the guard clamp firmly locks the guard onto the spindle housing.

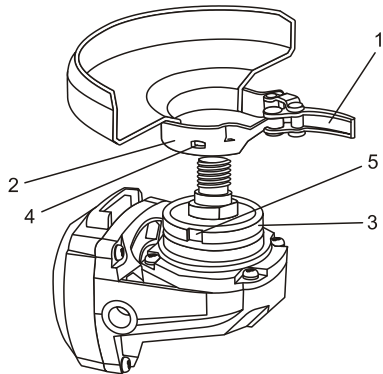

Fig. 2

POSITIONING THE GUARD

⚠ WARNING: The guard must be positioned correctly to protect the operator. Guard placement depends upon which side of the tool the auxiliary handle is used, to afford the greatest protection for the user. Rotate the guard to the correct position as noted in Fig. 4 or 5 below.

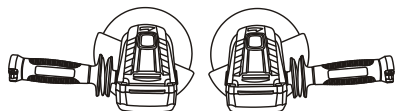

Fig. 3

Fig. 4

ASSEMBLY AND OPERATING

CHANGING A GRINDING DISC

⚠ WARNING: Use the correct size grinding disc. Never use a grinding disc thinner than 5/32" (3.9 mm).

⚠ WARNING: Never use a grinding disc with a rated speed of less than (11,800 RPM). A grinding disc with a rated speed of less than 11,800 RPM can break and fly apart.

1. Lock the disc guard onto the spindle housing.
2. Depress the spindle lock button (1) and rotate the grinding disc (2) until the spindle locks (Fig. 5).
3. Grasp the grinding disc and rotate the grinding disc in a counter clockwise direction. Once the grinding disc and outer disc flange (3) are loose, continue to turn the outer disc flange counter clockwise by hand until it is removed from the spindle (4).
4. Remove the grinding disc from the spindle.

NOTES:

- a) If the outer flange cannot be loosened by hand, use the wrench provided.
- b) DO NOT remove the inner disc flange (5).

5. Make sure the flats on the inner disc flange are engaged with the flats on the spindle (6).
6. Place the grinding disc over the spindle with the concave side of the disc (7) facing outward.
7. Screw the outer disc flange onto the spindle with the flat side of nut facing away from the grinding disc. Tighten to finger tight only.

NOTES:

- a) When installing a **grinding disc**, make sure the raised small diameter portion of both the inner and outer disc flanges are fitted into the hole in the grinding disc.

b) When installing a **cut-off disc**, make sure the large flat side of the outer disc flange is facing the cut-off disc.

8. Depress the spindle lock button and rotate the grinding disc clockwise until the spindle locks.
9. Grasp the grinding disc and turn it clockwise to securely tighten the grinding disc and outer flange onto the spindle.

NOTE: You may also tighten the grinding disc and outer flange onto the spindle using the wrench provided.

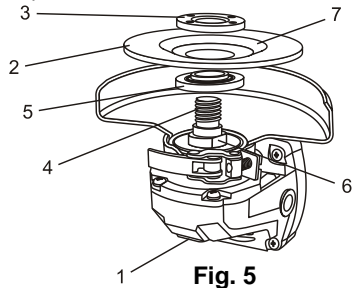

Fig. 5

⚠ WARNING

For safety reasons, the operator must read the sections of this Owner's Manual entitled "GENERAL SAFETY WARNINGS", "POWER TOOL SAFETY", "SPECIFIC SAFETY RULES", "EXTENSION CORD SAFETY" and "SYMBOLS" before using this angle grinder.

Verify the following every time the grinder is used:

1. Power cord is not damaged.
2. Grinding disc is correct for the type of material being ground
3. Grinding disc is in good condition and securely tightened onto the spindle
4. Proper eye, hearing and breathing protection are being worn.

Failure to adhere to these safety rules can greatly increase the chances of serious injury.

ASSEMBLY AND OPERATION

⚠ WARNING: Never attach a wood cutting or carving blade of any type to this angle grinder. It is designed for grinding metal only. Use for any other purpose is not recommended and creates a hazard which will result in serious injury.

⚠ WARNING: Never cover the air vents. They must always be open for proper motor cooling.

ON/OFF SWITCH AND LOCK-ON BUTTON

1. To turn the switch ON, pull the lock-off toggle (1) back and then squeeze the switch lever (2). (Fig. 6). To turn the switch OFF, release the switch lever.
2. To activate the lock-on switch while the angle grinder is running, press the lock-on button (3). While holding the lock-on button inward, release the ON/OFF switch. The angle grinder will continue to run.
3. To turn the angle grinder OFF, squeeze and release the ON/OFF switch.

⚠ WARNING: When turning the angle grinder OFF, always wait until the grinding disc comes to a complete stop before setting the tool down.

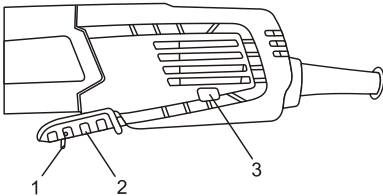

Fig. 6

GRINDING

Always select and use grinding discs that are recommended for the material to be ground. Make sure that the maximum operating speed of the grinding disc selected is **not less than** 11,800 RPM.

Secure all work before beginning the grinding operation.

Secure small workpieces in a vice or clamp to a workbench.

⚠ WARNING: Never use your angle grinder with the guard removed. It has been designed for use only with the guard installed. Attempting to use the angle grinder with the guard removed will result in loose particles being thrown against the operator resulting in serious personal injury.

⚠ WARNING: Never use your angle grinder without eye protection. Following this rule will reduce the risk of serious personal injury.

The efficient operation of the angle grinder begins by controlling the pressure and surface contact between the grinding disc and the workpiece. Flat surfaces are ground at an acute angle, normally between 5° and 15° (Fig. 7).

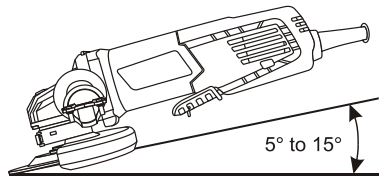

Fig. 7

For maximum control, hold the angle grinder in front and away from you with both hands, keeping the grinding disc clear of the workpiece. Start your angle grinder and let the motor and grinding disc build up to full speed. Gradually lower the angle grinder until the grinding disc contacts the workpiece.

For best results keep the angle grinder tilted at an angle of between 5° and 15° degrees and continuously moving at a steady, consistent pace. Move the angle grinder back and forth or up and down over the work area. Keep the angle grinder moving so that an excessive amount of material is not removed from one area. If the angle grinder is held in one spot too long, it will gouge and cut grooves in the workpiece. If the angle grinder is held at too sharp an angle, it will gouge the workpiece because of the concentration of pressure on a small area.

ASSEMBLY AND OPERATING

GRINDING – cont'd

Use just enough pressure to keep the angle grinder from chattering or bouncing. Heavy pressure will decrease its speed and put a strain on the motor. Normally, the weight of the tool alone is adequate for most grinding jobs. Use light pressure when grinding jagged edges or loose bolts where there is potential for the angle grinder to snag on the metal edge.

Lift the angle grinder away from the workpiece before turning it OFF.

▲ WARNING: Always wait until the grinding disc comes to a complete stop before setting the tool down.

MAINTENANCE

GENERAL

▲ WARNING: When servicing, use only identical replacement parts. The use of any other part may create a hazard or cause product damage.

DO NOT use solvents when cleaning plastic parts. Plastics are susceptible to damage from various types of commercial solvents and may be damaged by their use. Use a clean cloth to remove dirt, dust, oil, grease etc.

▲ WARNING: Do not allow brake fluids, gasoline, petroleum-based products, penetrating oils, etc. to come into contact with plastic parts. They contain chemicals that can damage, weaken or destroy plastic.

MAINTENANCE

DO NOT abuse power tools. Abusive practices can damage the tool and the workpiece.

▲ WARNING: DO NOT attempt to modify tools or create accessories. Any such alteration or modification is misuse and could result in a hazardous condition leading to possible serious injury. It will also void the warranty.

It has been found that electric tools are subjected to accelerated wear and possible premature failure when they are used on fiberglass boats and sports cars, wallboard, spackling compounds or plaster. The chips and grindings from these materials are highly abrasive to electric tool parts such as bearings, brushes, commutators, etc. Consequently, it is not recommended that this tool be used for extended work on any fiberglass material, wallboard, spackling compounds or plaster. During any use on these materials it is extremely important that the tool is cleaned frequently by blowing it out with an air jet.

▲ WARNING: Always wear safety goggles or safety glasses with side shields during all cutting operations. It is critical that you also wear safety goggles or safety glasses with side shields and a dust mask while blowing dust out of the angle grinder with an air jet. Failure to take these safety precautions could result in permanent eye or lung damage.

If the motor brushes require replacement, contact the toll free customer support line: 1-866-349-8665 Monday – Friday from 9am to 5pm Eastern Standard Time

LUBRICATION

All of the bearings in this tool are lubricated with a sufficient amount of high-grade lubricant for the life of the unit under normal conditions. Therefore, no further lubrication is required.

MAINTENANCE

REMOVING MOTOR BRUSHES

Motor brushes are a normal wear item and will require replacing periodically depending upon the type of material being ground. The following information outlines the general procedure for removal of the worn brushes and installation of the new brushes.

▲ WARNING: Make sure the angle grinder is unplugged from the power source.

Removing worn brushes

1. Remove the grinding disc (Fig. 5).
2. Remove the disc guard (Fig. 2).
3. Lay the tool on its left side on a towel or on corrugated (Fig. 8).
4. Remove 6 screws (1) from the right hand side of the handle using a #2 \oplus screwdriver.
5. Carefully pry off the right half of the handle (2) using a small slot screwdriver (3).

NOTE: Be careful not to bruise the handle housing to ensure easy re-assembly.

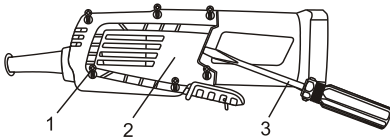

Fig. 8

6. Remove the switch paddle arm (4) by lifting it upward (Fig. 9).
7. Remove the lock-on button (5) by lifting it out of the left half of the handle (6).
NOTE: Be careful not to lose the spring (7) that is on the lock-off button.

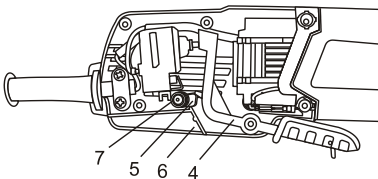

Fig. 9

8. Pry the left half of the handle about $\frac{3}{4}$ " away from the motor housing using a small slot screwdriver.

NOTE: Do not pry the left half of the handle completely off the motor housing. You will dislodge the switch assembly and make re-assembly more difficult.

9. Turn the tool on its back with the spindle pointing upward (Fig. 10).

NOTE: Pay attention to the position of the braided copper brush wire (12). When the new carbon brush is reinstalled, the braided brush wire **MUST** be placed in exactly the same position.

10. Use a small slot screwdriver to lift the end of the coil spring (8) upward and place it on top of the \oplus screw (9).
11. Use small needle nose pliers to pull the top spade connector (10) from the spade terminal (11).
12. Carefully grasp the braided copper brush wire (12) and lift the carbon brush (13) from the brush holder (14).

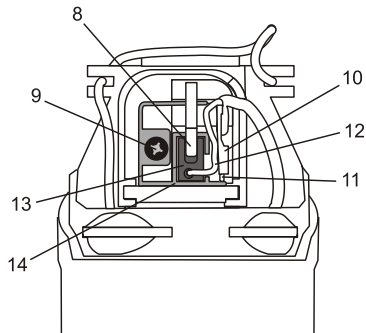

Fig. 10

MAINTENANCE

INSTALLING NEW MOTOR BRUSHES

13. Once the old carbon brush has been removed, use a SOFT DRY brush to carefully remove all grinding dust from the brush holder and install the new carbon brush in the reverse order that was used to remove the worn carbon brush.
14. Reinstall the new carbon brush in reverse order of paragraphs 10, 11 & 12.

NOTES:

- a) Make sure the braided brush wire is routed EXACTLY the same as the original.
 - b) Make sure the end of the coil spring is placed on top of the carbon brush (Fig. 10).
15. Turn the tool onto its face to remove and replace the second carbon motor brush using the same procedures noted above.
 16. Once both carbon brushes have been replaced, reposition the left half of the handle, place the lock-on button & spring assembly and switch lever where they were removed.
 17. Replace the right hand half of the handle, making sure it fits properly and that all six screws are fully tightened in place.

EXPLODED VIEW

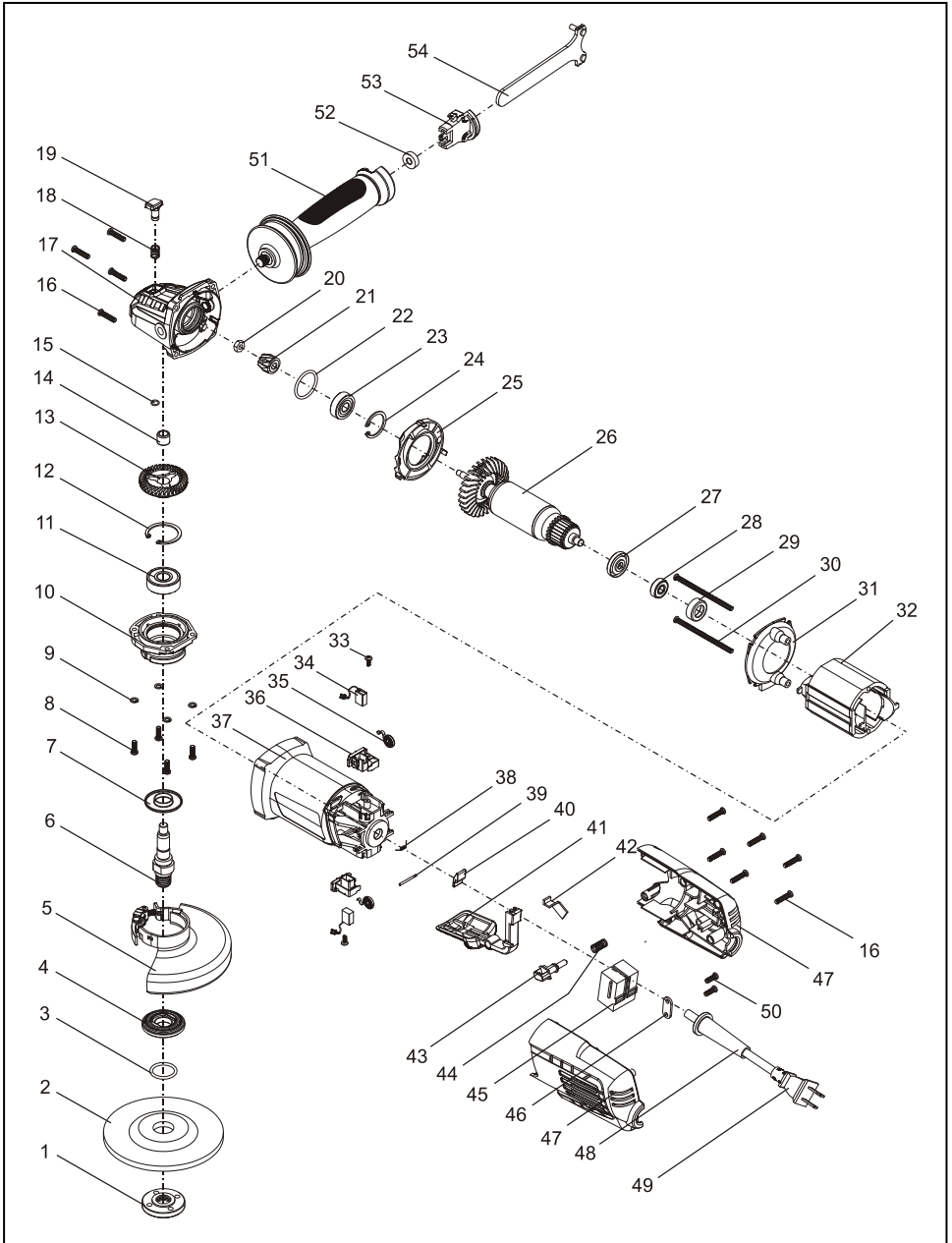

PARTS LIST

⚠ WARNING: When servicing, use only original equipment replacement parts. The use of any other parts may create a safety hazard or cause damage to the angle grinder.

Any attempt to repair or replace electrical parts on this angle grinder may create a safety hazard unless repairs are performed by a qualified technician. For more information, call the Toll-free Helpline, at
1-866-349-8665 – Friday from 9am to 5pm Eastern Standard Time.

Always order by PART NUMBER, not by key number.

Key #	Part #	Part Name	Quantity
1	2040210006	Outer flange	1
2	6080010001	Grinding wheel	1
3	3140070022	Disc brake "O" ring	1
4	2010140054	Inner flange	1
5	1270030016	Safety wheel guard	1
6	2040040103	Output spindle	1
7	2030170001	Dustproof ring	1
8	4020010003	Screw M4*12	4
9	4040030001	Ø4 Spring washer	4
10	2020150076	Gear cover	1
11	4010010081	Bearing 6201 RS	1
12	4100010005	Circlip for shaft Ø32	1
13	2040110041	Driven gear	1
14	4010020003	HK0810 needle bearing	1
15	4100040006	Circlip for shaft Ø7	1
16	4030010106	Screw ST3.9*19	10
17	2020050073	Gear housing	1
18	2050040061	Spindle lock spring	1
19	1160010020	Spindle lock button	1
20	4060010022	Nut M5	1

PARTS LIST

Key #	Part #	Part Name	Quantity
21	2040110042	Pinion gear	1
22	3140020049	Oil sealing "O" ring	1
23	4010010014	Bearing 629 RS	1
24	4100010002	Assembly circlip Ø26	1
25	3150050087	Air deflector	1
26	1010150053	Rotor	1
27	3150190020	Dust cover	1
28	4010010053	Bearing 607RS	1
29	3140040001	Bearing sleeve	1
30	4030010106	Screw ST 3.9*75	2
31	3150050088	Air baffle plate	1
32	1020150035	Stator	1
33	4030010023	Screw ST2.9*8	2
34	1230010142	Carbon brush	2
35	1230030026	Brush holder	2
36	2050020025	Brush spring	2
37	3011150025	Motor housing	1
38	2050050051	Lock off button spring	1
39	4130010016	Cotter pin	1
40	2020230004	Lock-off button spring	1
41	3120010096	Switch button	1
42	3150130131	outlet vents cover	1
43	3120040062	Switch lock button	1
44	2050040062	Switch lock button spring	1
45	1062020062	Switch	1
46	2030050002	Cord clamp	1
47	5618080101	Handle assembly	1
48	3140010006	Strain relief	1
49	1190030058	Power cord	1
50	4030010096	Screw ST 3.9*12	2
51	1160020045	Side handle	1
52	2040310040	Ø 6 ring	1
53	3150160205	Spanner holder	1
54	6140030011	Spanner	1



4-1/2" ANGLE GRINDER WITH PADDLE SWITCH WARRANTY

90-DAY MONEY BACK GUARANTEE:

This MASTERFORCE® brand power tool carries our 90-Day Money Back Guarantee. If you are not completely satisfied with your MASTERFORCE® brand power tool for any reason within ninety (90) days from the date of purchase, return the tool with your original receipt to any MENARDS® retail store, and we will provide you a refund – no questions asked.

3-YEAR LIMITED WARRANTY:

This MASTERFORCE® brand power tool carries our famous No Hassle 3-Year Limited Warranty to the original purchaser. If, during normal use, this MASTERFORCE® power tool breaks or fails due to a defect in material or workmanship within three (3) years from the date of original purchase, simply bring the tool with the original sales receipt back to your nearest MENARDS® retail store. At its discretion, MASTERFORCE® agrees to have the tool or any defective part(s) repaired or replaced with the same or similar MASTERFORCE® product or part free of charge, within the stated warranty period, when returned by the original purchaser with original sales receipt. Notwithstanding the foregoing, this limited warranty does not cover any damage that has resulted from abuse or misuse of the Merchandise. This warranty: (1) excludes expendable parts including but not limited to blades, brushes, belts, bits, light bulbs, and/or batteries; (2) shall be void if this tool is used for commercial and/or rental purposes; and (3) does not cover any losses, injuries to persons/property or costs. This warranty does give you specific legal rights and you may have other rights, which vary from state to state. Be careful, tools are dangerous if improperly used or maintained. Seller's employees are not qualified to advise you on the use of this Merchandise. Any oral representation(s) made will not be binding on seller or its employees. The rights under this limited warranty are to the original purchaser of the Merchandise and may not be transferred to any subsequent owner. This limited warranty is in lieu of all warranties, expressed or implied including warranties of merchantability and fitness for a particular purpose. Seller shall not be liable for any special, incidental, or consequential damages. The sole exclusive remedy against the seller will be for the replacement of any defects as provided herein, as long as the seller is willing or able to replace this product or is willing to refund the purchase price as provided above. For insurance purposes seller is not allowed to demonstrate any of these power tools for you.

For questions / comments, technical assistance or repair parts –
Please call toll free at: **1-866-349-8665** (M-F 9am – 5pm).

**SAVE YOUR RECEIPTS
THIS WARRANTY IS VOID WITHOUT THEM**

MASTERFORCE[®]

MENARDS[®]