

Radley®

120V • 60Hz • 1.2 Amp

Rotary Tool Kit



Owner's Manual
35 piece
accessory kit

UL US
LISTED
611N
E213739
JD3315U

**READ ALL INSTRUCTIONS BEFORE FIRST USE.
KEEP THIS MANUAL FOR FUTURE REFERENCE.
KEEP AWAY FROM CHILDREN.**



**WEAR CSA APPROVED
EYE PROTECTION**



**WEAR EAR
PROTECTION**



**WEAR A
FACE MASK**

PRODUCT SPECIFICATIONS

Rating:	120 V, 60 Hz AC
Amperes:	1.2 A
RPM:	10,000–35,000 RPM (no load)
Collets:	3/32" & 1/8"
Weight:	1 lb 8 oz (0.67 kg)

Need Assistance?

Call us on our toll free customer support line:

1-866-349-8665 (Monday through Friday 9am – 5pm eastern time)

- Technical questions
- Replacement parts
- Parts missing from package



TABLE OF CONTENTS

Product specifications	1
Table of contents	2
General safety warnings	3
Eye, ear & lung protection	3
Electrical safety	4
Power tool safety	4
Work area safety	4
Electrical safety	5
Personal safety	5-6
Power tools use and care	6
Service	6
Specific safety rules	7-8
Extension cord safety	8
Symbols	9
Know your rotary tool	10
Accessories	11
Accessory description & use	12
Assembly and operating	13-14
Variable speed control wheel	13
ON/OFF switch	13
Changing the collet	13
Installing accessories	14
Selecting proper speeds	14
Maintenance	15
Exploded view	16
Parts list	17
Warranty	18

GENERAL SAFETY WARNINGS

WARNING: Before using this tool or any of its accessories, read this manual and follow all Safety Rules and Operating Instructions. The important precautions, safeguards and instructions appearing in this manual are not meant to cover all possible situations. It must be understood that common sense and caution are factors which cannot be built into the product.

This instruction manual includes the following:

- General Safety Warnings
- Specific Safety Rules and Symbols
- Assembly
- Operation
- Maintenance
- Accessories

EYE, EAR & LUNG PROTECTION



**WEAR CSA APPROVED
EYE PROTECTION**



**WEAR EAR
PROTECTION**



**WEAR A
FACE MASK**

ALWAYS WEAR EYE PROTECTION THAT CONFORMS WITH CSA REQUIREMENTS or ANSI SAFETY STANDARD Z87.1

FLYING DEBRIS can cause permanent eye damage. Prescription eyeglasses ARE NOT a replacement for proper eye protection. **WARNING:** Non-compliant eyewear can cause serious injury if broken during the operation of a power tool.

ALWAYS WEAR EAR PROTECTION

WARNING: Use hearing protection, particularly during extended periods of operation of the tool, or if the operation is noisy.

WEAR A DUST MASK THAT IS DESIGNED TO BE USED WHEN OPERATING A POWER TOOL IN A DUSTY ENVIRONMENT.

WARNING: Dust that is created by power sanding, sawing, grinding, drilling, and other construction activities may contain chemicals that are known to cause cancer, birth defects, or other genetic abnormalities. These chemicals include: Lead from lead-based paints; Crystalline silica from bricks, cement, and other masonry products; Arsenic and chromium from chemically treated lumber. The level of risk from exposure to these chemicals varies, according to how often this type of work is performed. In order to reduce exposure to these chemicals, work in a well-ventilated area, and use approved safety equipment, such as a dust mask that is specifically designed to filter out microscopic particles.

ELECTRICAL SAFETY



WARNING: To avoid electrical hazards, fire hazards or damage to the tool, use proper circuit protection.

This tool is wired at the factory for 120 V AC operation. It must be connected a 120 V AC, 15 A circuit that is protected by a time-delayed fuse or circuit breaker. To avoid shock or fire, replace power cord immediately if it is worn, cut or damaged in any way.

POWER TOOL SAFETY

WARNING: Read all safety warnings and instructions. Failure to follow the warnings and instructions may result in electric shock, fire and/or serious injury. **Save all warnings and instructions for future reference.**

WORK AREA SAFETY

Keep work area clean and well lit. Cluttered or dark areas invite accidents.

Do not operate power tools in explosive atmospheres, such as in the presence of flammable liquids, gases or dust. Power tools create sparks which may ignite the dust or fumes.

Keep children and bystanders away while operating a power tool. Distractions can cause you to lose control.

ELECTRICAL SAFETY

Power tool plugs must match the outlet. Never modify the plug in any way. Do not use any adapter plugs with earthed (grounded) power tools. Unmodified plugs and matching outlets will reduce risk of electric shock.

Avoid body contact with earthed or grounded surfaces such as pipes, radiators, ranges and refrigerators. There is an increased risk of electric shock if your body is earthed or grounded.

Do not expose power tools to rain or wet conditions. Water entering a power tool will increase the risk of electric shock.

Do not abuse the cord. Never use the cord for carrying, pulling or unplugging the power tool. Keep cord away from heat, oil, sharp edges or moving parts. Damaged or entangled cords increase the risk of electric shock.

When operating a power tool outdoors, use an extension cord suitable for outdoor use. Use of a cord suitable for outdoor use reduces the risk of electric shock.

If operating a power tool in a damp location is unavoidable, use a residual current device (RCD) protected supply. Use of a ground fault circuit interrupter (GFCI) reduces the risk of electric shock.

PERSONAL SAFETY

Stay alert, watch what you are doing and use common sense when operating a power tool. Do not use a power tool while you are tired or under the influence of drugs, alcohol or medication. A moment of inattention while operating power tools may result in serious personal injury.

Use personal protective equipment. Always wear eye protection. Protective equipment such as dust mask, non-skid safety shoes, hard hat, or hearing protection used for appropriate conditions will reduce personal injuries.

Prevent unintentional starting. Ensure the switch is in the off-position before connecting to power source and/or battery pack, picking up or carrying the tool. Carrying power tools with your finger on the switch or energizing power tools that have the switch on invites accidents.

Remove any adjusting key or wrench before turning the power tool on. A wrench or a key left attached to a rotating part of the power tool may result in personal injury.

Do not overreach. Keep proper footing and balance at all times. This enables better control of the power tool in unexpected situations.

Dress properly. Do not wear loose clothing or jewelry. Keep your hair, clothing and gloves away from moving parts. Loose clothes, jewellery or long hair can be caught in moving parts.

If devices are provided for the connection of dust extraction and collection facilities, ensure these are connected and properly used. Use of dust collection can reduce dust-related hazards.

POWER TOOL USE AND CARE

Do not force the power tool. Use the correct power tool for your application. The correct power tool will do the job better and safer at the rate for which it was designed.

Do not use the power tool if the switch does not turn it on and off. Any power tool that cannot be controlled with the switch is dangerous and must be repaired.

Disconnect the plug from the power source and/or the battery pack from the power tool before making any adjustments, changing accessories, or storing power tools. Such preventive safety measures reduce the risk of starting the power tool accidentally.

Store idle power tools out of the reach of children and do not allow persons unfamiliar with the power tool or these instructions to operate the power tool. Power tools are dangerous in the hands of untrained users.

Maintain power tools. Check for misalignment or binding of moving parts, breakage of parts and any other condition that may affect the power tool's operation. If damaged, have the power tool repaired before use. Many accidents are caused by poorly maintained power tools.

Keep cutting tools sharp and clean. Properly maintained cutting tools with sharp cutting edges are less likely to bind and are easier to control.

Use the power tool, accessories and tool bits etc. in accordance with these instructions, taking into account the working conditions and the work to be performed. Use of the power tool for operations different from those intended could result in a hazardous situation.

Service

Have your power tool serviced by a qualified repair person using only identical replacement parts. This will ensure that the safety of the power tool is maintained.

 **SPECIFIC SAFETY RULES**

WARNING: Know your rotary tool. Do not plug the tool into the power source until you have read and understand this Instruction Manual. Learn the tool's applications and limitations, as well as the specific potential hazards related to this tool. Following this rule will reduce the risk of electric shock, fire, or serious injury.

**WEAR CSA
APPROVED
EYE PROTECTION**

Always wear eye protection. Any power tool can throw foreign objects into your eyes and cause permanent eye damage. ALWAYS wear safety goggles (not glasses) that comply with ANSI safety standard Z87.1. Everyday glasses have only impact resistant lenses. They ARE NOT safety glasses.

WARNING: Glasses or goggles not in compliance with ANSI Z87.1 could cause serious injury when they break.

Hold tool by insulated gripping surfaces when performing an operation where the cutting tool may contact hidden wiring or its own cord. Contact with a "live" wire will make exposed metal parts of the tool "live" and shock the operator.

Always make sure the work surface is free from nails and other foreign objects. Cutting into a nail can cause the bit and the tool to jump and damage the bit.

Never hold the workpiece in one hand and the tool in the other hand when in use. Never place the hands near or below the cutting surface. Clamping the material and guiding the tool with both hands is much safer.

Never lay workpiece on hard surfaces like concrete, stone, etc. Protruding cutting bit may cause the tool to jump.

Always wear safety goggles and dust mask. Use only in well-ventilated area. Using personal safety devices and working in a safe environment reduces risk of injury.

After changing the bits and accessories or making adjustments, make sure the collet nut and any other adjustment devices are securely tightened. Loose adjustment devices will be violently thrown.

Always use the correct collet size. If the collet size is larger than the accessory shank size it will not grip the shank properly, leading to possible injury to the operator or damage to the tool.

Always check accessory bits, grinding stones, cut-off wheels etc. for damage before each use. Damaged accessories can break during use and cause serious injury.

Never use dull or damaged bits. Sharp bits must be handled with care. Damaged bits can snap during use. Dull bits require more force to push the tool, possibly causing the bit to break.

Never touch the bit during or immediately after use. After use the bit is too hot to be touched by bare hands.

When using any new accessory for the first time, particularly wire wheels, bristle brushes and grinding stones, run the tool at full speed for one minute to remove any loose wires, bristles or stone particles. **During this initial run-up, always wear a face shield and make sure you are NOT in line with the rotating accessory to avoid injury caused by flying debris.**

GUIDELINES FOR EXTENSION CORDS

Make sure your extension cord is the proper size. When using an extension cord, be sure to use one heavy enough to carry the current the tool will draw. An undersized cord will cause a drop in line voltage resulting in loss of power and overheating. The table on at right shows the correct size to use according to cord length and nameplate ampere rating. If in doubt, use the next heavier gauge. The smaller the gauge number the heavier the cord.

Be sure your extension cord is properly wired and in good condition. Always replace a damaged extension cord or have it repaired by a qualified electrician before using it. Protect your extension cord from sharp objects, excessive heat and damp or wet areas.

Use a separate electrical circuit for your power tools. This circuit must not be less than 14-gauge wire and should be protected with either a 15A time delay fuse or circuit breaker. Before connecting the power tool to the power source, make sure the switch is in the OFF position and the power source is the same as indicated on the nameplate. Running at lower voltage will damage the motor.

! WARNING: Repair or replace damaged or worn extension cords immediately.

Select the appropriate extension cord gauge and length using the chart to the below.



When operating a power tool outdoors, use an outdoor extension cord marked “W-A” or “W”. These cords are rated for outdoor use and reduce the risk of electric shock.









! WARNING: Keep the extension cord clear of the working area. Position the cord so it will not get caught on the workpiece, tools or any other obstructions while you are working with the power tool.

MINIMUM GAUGE (AWG) EXTENSION CORDS (120 V use only)					
Ampere rating		Total length in feet			
More than	Not more than	7.5 m (25')	15 m (50')	30 m (100')	45 m (150')
0	6	18	16	16	14
6	10	18	16	14	12
10	12	16	16	14	12
12	16	14	12	Not Applicable	

SYMBOLS

WARNING: Some of the following symbols may appear on the rotary tool. Study these symbols and learn their meaning. Proper interpretation of these symbols will allow for more efficient and safer operation of this tool.

V	Volts
A	Amperes
Hz	Hertz
W	Watts
kW	Kilowatts
μF	Microfarads
L	Liters
kg	Kilograms
H	Hours
N/cm ²	Newtons per square centimeter
Pa	Pascals
OPM	Oscillations per minute
Min	Minutes
S	Seconds
 or a.c.	Alternating current
	Three-phase alternating current
	Three-phase alternating current with neutral

	Direct current
n_0	No load speed
	Alternating or direct current
	Class II construction
	Splash-proof construction
	Watertight construction
	Protective grounding at grounding terminal, Class I tools
.../min	Revolutions or reciprocations per minute
∅	Diameter
0	Off position
	Arrow
	Warning symbol
	Wear your safety glasses



This symbol designates that this tool is listed with U.S. requirements by Underwriters Laboratories. Conforms to UL Std. 60745-1.

KNOW YOUR ROTARY TOOL

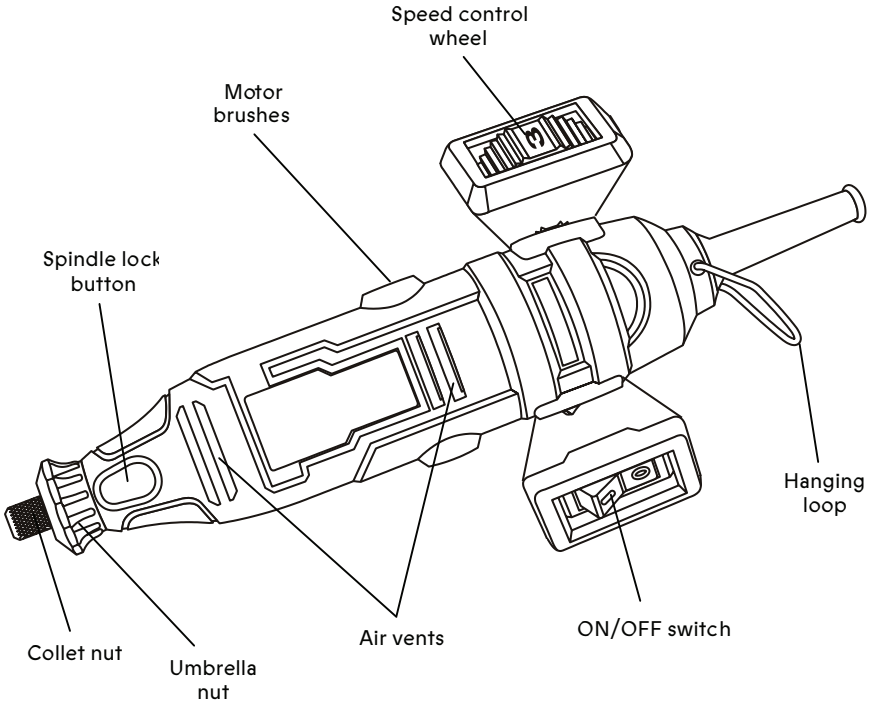
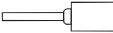



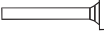

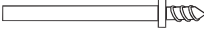





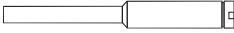
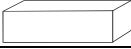





Illustration	Description	Shape	Qty
	Aluminum oxide grindingstone	Cylinder 3/8"	1
	Aluminum oxide grinding stone	Cone 5/8"	1
	Aluminum oxide grinding stone	Parabolic 3/8"	1
	Aluminum oxide grinding stone	Cylinder 13/32"	1
	Aluminum oxide grinding stone	Cylinder 5/32"	1
	Felt polishing wheel	1/2"	2
	Felt polishing wheel	1"	2
	Mandrel	1/8" for felt polishing wheels	1
	Bristle brush	3/4" radial	1
	Sanding band	1/2" 60-grit	3
	Drum sander	1/2" with 1/8" shank	1
	Sanding disc	3/4" 60-grit	3
	Heavy-duty Cut-off wheel	15/16" x 0.031"	6
	Regular-duty cut-off wheel	15/16" x 0.025"	6
	Screw mandrel	1/8" for sanding discs, cut-off wheels, cloth wheels & grinding wheels	1
	Dressing stone	3/8" x 1" square	1
	Collet	1/8" (packed in tool)	1
	Collet	3/32"	1
	Wrench	For collet nut, drum sander & screw mandrel	1

ACCESSORY DESCRIPTION & USE

There are many different types of accessories that can be used with this rotary tool. The following charts identify the most popular accessories and their uses.

NOTE: Please see the accessory listing on Page 11 to identify the accessories that are included with this rotary tool.

Accessory Description	Accessory Use
Sanding disc	For shaping and smoothing wood and fiberglass; removing rust from metal surfaces.
Aluminum oxide <ul style="list-style-type: none"> ▪ Grinding stones ▪ Grinding wheels ▪ Abrasive wheels 	Use on metals, castings, welded joints, rivets and rust. Ideal for sharpening, deburring, rust removal and general-purpose grinding of most materials.
Bristle brush	Use for light deburring, cleaning and polishing of silverware, jewellery and other precious metals. Can be used with polishing compound.
Sanding band	For rough shaping and smoothing wood and fiberglass; removing rust from metal surfaces; shaping rubber surfaces. Sanding bands are easily replaceable on drums.
Drum sander	Ideal for rough-shaping and smoothing wood and fiberglass — as well as removing rust from metal surfaces, shaping rubber surfaces and more.
Screw mandrel	Use with sanding discs and polishing, grinding and cut-off wheels.
Collet	For use with accessories.
Collet wrench	For tightening & loosening collet nut, screw of drum sanders
Abrasive buff <ul style="list-style-type: none"> ▪ Emery-impregnated 	Ideal for cleaning and polishing coarse surfaces.
Steel brush	Stainless steel brushes do not cause "after-rust" when used on corrosive-resistant materials like pewter, aluminum and stainless steel.
Diamond wheel point	Great for cutting, sawing and carving of hard materials such as marble, concrete, brick, porcelain, ceramics, hard epoxy and soft and hard wood.

NOTE: This Radley Rotary Tool is compatible with most accessories and attachments provided by other leading brands.

ASSEMBLY AND OPERATING

VARIABLE SPEED CONTROL WHEEL

Set the rotary tool speed by rotating the variable speed control wheel (1) to the appropriate speed (Fig. 1). Position the speed control wheel at "1" for slowest speed, "3" for medium speed and at "MAX" for the highest speed.

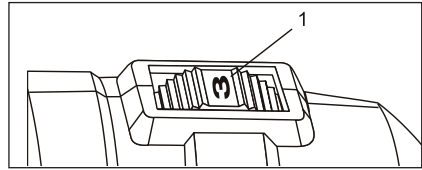

Fig. 1

ON/OFF SWITCH

To turn the switch ON, push on the lower part of the ON/OFF switch (1) (Fig. 2). To turn the switch OFF, push on the upper part of the ON/OFF switch (2).

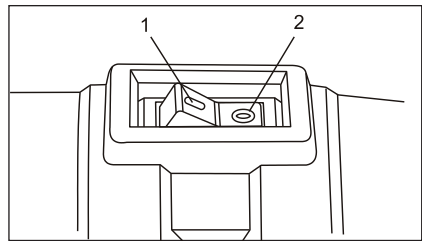

Fig. 2

CHANGING THE COLLET

Some accessories require the use of different sized collets. Collet sizes can be 1/16", 3/32" and 1/8". It is important to ensure that the collet size matches the accessory.

NOTE: This tool includes the most commonly used collets: 3/32" and 1/8".

WARNING: Using a collet that is too large for the accessory will result in the accessory possibly being thrown from the tool causing serious injury.

1. Turn the tool switch OFF and remove the plug from the power source.

2. Depress the spindle lock button (1) and slowly turn the collet nut (2) until the spindle lock button locks the spindle (3) (Fig. 3).

3. While holding the spindle lock button down, turn the collet nut counterclockwise until it is removed.

4. Remove the collet (4) by pulling it out of the spindle.

5. Insert the replacement collet into the spindle and replace the collet nut by turning it clockwise while holding the spindle lock button down.

NOTE: Do not tighten the collet nut without an accessory installed in the collet. You will damage the collet.

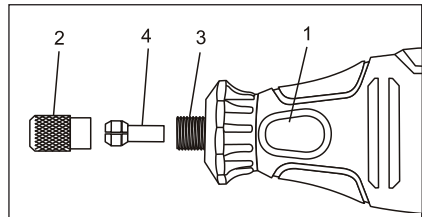

Fig. 3

ASSEMBLY AND OPERATING

INSTALLING ACCESSORIES

1. Turn the switch OFF and disconnect the tool from the power source.
2. Depress the spindle lock button (1) and slowly turn the collet nut (2) until the spindle lock button locks the spindle (Fig. 4).
3. While holding the spindle lock button down, turn the collet nut counter- clockwise until the collet is loose inside the collet nut.
4. Insert the accessory (3) into collet.

NOTES:

a) Make sure the correct collet is used for the accessory. If collet is too large, replace the collet with the next smaller size. b) Insert accessory at least 3/4" into the collet.

5. Press the spindle lock button and engage it in the spindle. While holding the spindle lock button down, hand-tighten the collet by turning it clockwise.

NOTE: Do not use pliers to tighten the collet nut. Use the small wrench (4) supplied. Over tightening will cause damage to the tool.

6. Pull on the accessory to ensure it is securely in place

WARNING: When using any new accessory for the first time, particularly wire wheels, bristle brushes and grinding stones, run the tool at full speed for one minute to remove any loose wires, bristles or stone particles. **During this initial run-up, always wear a face shield and make sure you are NOT in line with the rotating accessory to avoid injury caused by flying debris.**

SELECTING PROPER SPEEDS

Different speeds are required depending upon the type of operation being performed. The chart to the right outlines those basic speeds:

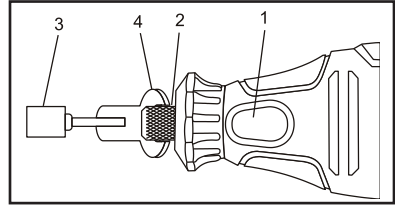

Fig. 4

WARNING

For safety reasons, the operator must read the sections of this Owner's Manual entitled "GENERAL SAFETY WARNINGS", "POWER TOOL SAFETY", "SPECIFIC SAFETY RULES", "EXTENSION CORD SAFETY" and "SYMBOLS" before using this rotary tool.

Verify the following every time the rotary tool is used:

1. Safety glasses, safety goggles, or face shield are being worn.
2. Accessory is in good condition and not damaged in any way.
3. Workpiece is properly secured.

Failure to observe these safety rules will significantly increase the risk of injury.

OPERATION	SPEED
Cutting metal	5-MAX
Sanding wood	5-MAX
Cutting hard metal	5-MAX
Engraving metal	4-5
De-burring	4-5
Drilling holes	4-5
Removing rust	3-4
Sharpening	3-4
Polishing	1-2

MAINTENANCE

GENERAL

WARNING: When servicing, use only identical replacement parts. Use of any other part may create a hazard or cause product damage.

DO NOT use solvents when cleaning plastic parts. Most plastics are susceptible to damage from various types of commercial solvents and may be damaged by their use. Use clean cloth to remove dirt, dust, oil, grease etc.

WARNING: Do not at any time allow brake fluids, gasoline, petroleum-based products, penetrating oils, etc. to come in contact with plastic parts. They contain chemicals that can damage, weaken or destroy plastic.

DO NOT abuse power tools. Abusive practices can damage the tool as well as the workpiece.

WARNING: DO NOT attempt to modify this rotary tool or create accessories not recommended for use. Any such alteration or modification is misuse and could result in a hazardous condition leading to possible serious injury. It will also void the warranty.

LUBRICATION

All the bearings in this rotary tool are lubricated with a sufficient amount of high- grade lubricant for the life of the unit under normal conditions. Therefore, no further lubrication is required.

REPLACING THE CARBON MOTOR BRUSHES

The carbon motor brushes will wear down and require replacing. The time intervals between replacements will vary depending upon the torques being achieved and the hours of use. It is recommended that the brushes be checked after each 10 hours of use. When the length of the carbon brush reaches 1/4" (6.35 mm), the brushes should be replaced.

WARNING: Unplug the tool from the power source.

1. Use a small slot screwdriver and remove one brush cap (1) (Fig. 5). Turn the brush cap counterclockwise to remove it from the motor housing.
2. Pull the spring & brush assembly (2) from the brush holder (3) in the motor housing (4).
3. Insert the new spring & brush assembly into the motor housing.
4. Compress the spring into the brush holder and thread the brush cap back into the motor housing.

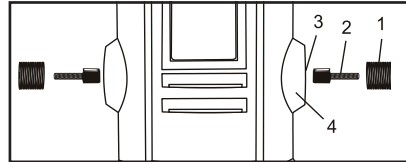
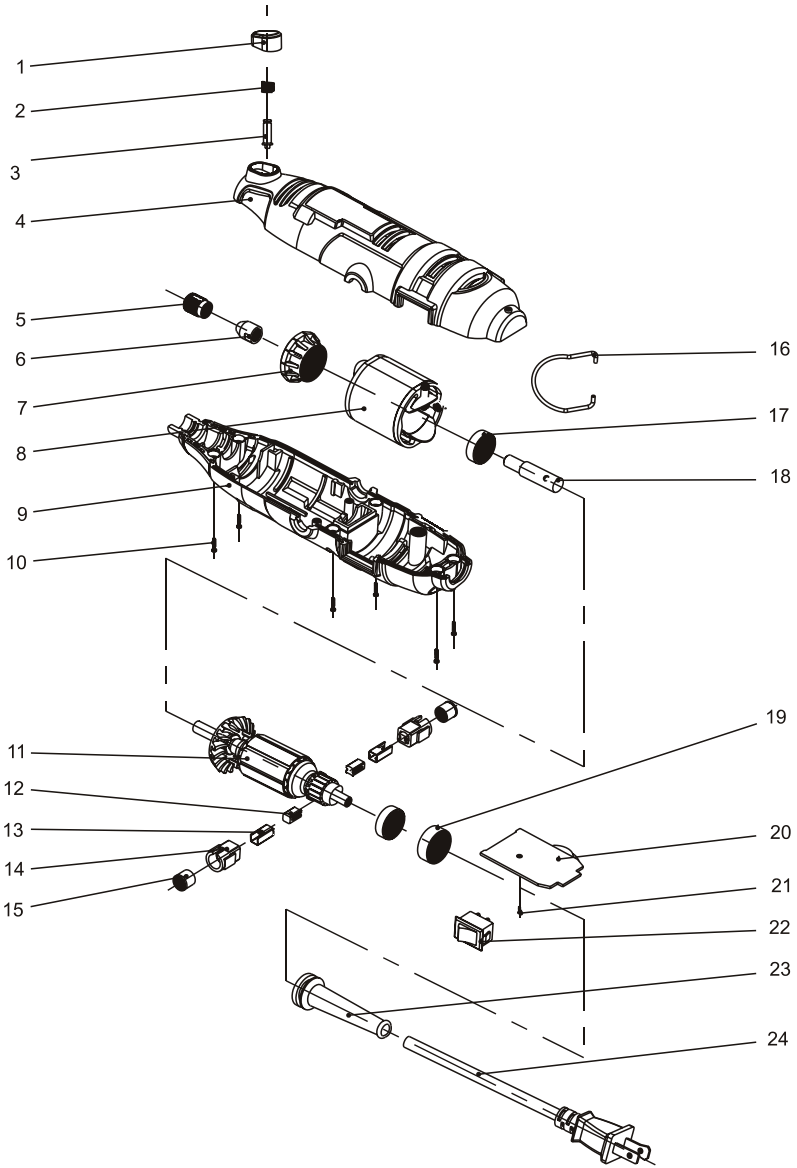

Fig. 5

NOTE: Make sure the brush cap threads are not cross threaded. Do NOT over tighten.

Repeat steps #1 to #4 and replace the second carbon brush located on the opposite side of the motor housing.



PARTS LIST

WARNING: When servicing, use only original equipment replacement parts. The use of any other parts may create a safety hazard or cause damage to the rotary tool.

Any attempt to repair or replace electrical parts on this rotary tool may create a safety hazard unless repairs are performed by a qualified technician. For more information, call the Toll-free Helpline, at 1-866-349-8665.

Always order by **PART NUMBER**, not by key number.

Key #	Part #	Part Name	Quantity
1	3120020118	Spindle locking button	1
2	2050040004	Lock pin spring	1
3	2040160105	Lock pin	1
4	30111 60019	Housing (upper)	1
5	2040190009	Collet nut	1
6	2040280001	Collet 1/8"	1
7	3150100012	Accessory collar	1
8	102016 0003	Stator	1
9	3011160019	Housing (lower)	1
10	4030010034	Tapping screw ST2.2X16	6
11	1010160003	Armature	1
12	123001 0026	Carbon brush	2
13	2030070011	Brush holder	2
14	3150060028	Brush holdersupport	2
15	3150140011	Brush holder nut	2
16	2050080122	Hanging loop	1
17	4010010031	Bearing 626Z	2
18	2040040041	Output shaft	1
19	3140040003	Bearing sleeve	1
20	1130010150	PCB with speed control	1
21	4030010020	Tapping screw ST2.9X6	1
22	106115 0001	Switch	1
23	3140010045	Cord strain relief	1
24	119 0030002	Cord set	1

WARRANTY

RADLEY ROTARY TOOL KIT WARRANTY

If this Radley Tool fails due to a defect in material or workmanship within one year from the date of purchase, return it to any Home Hardware store with the original bill of sale for exchange. This warranty does not include expendable parts including but not limited to blades, brushes, belts, light bulbs and / or batteries. This warranty covers defects in material or workmanship only. It does not cover normal wear and tear, failure due to abuse / misuse, or defects caused by careless or accidental mishandling. If this Radley product is used for commercial or rental purposes, this warranty does not apply.

120V • 60Hz • 1.2 Amp

Rotary Tool Kit

35 piece
accessory kit



Radley®

EXCLUSIVE TO HOME HARDWARE

For information on the entire line-up of Radley power
tools visit homehardware.ca or your local Home Hardware retail store.

MADE IN CHINA / FABRIQUÉ EN CHINE
HOME HARDWARE STORES LIMITED
ST. JACOBS, ONTARIO N0B 2N0
ORDER ONLINE / COMMANDE EN LIGNE
homehardware.ca

© 07 / 2019 Home Hardware Stores Limited



1281-914