

# Radley®



# 20V Max\* Snow Shovel

10"/25 cm  
clearing width  
Owner's Manual



3 Year  
limited  
warranty



ASYSN01

**READ ALL INSTRUCTIONS BEFORE FIRST USE.  
KEEP THIS MANUAL FOR FUTURE REFERENCE.  
KEEP AWAY FROM CHILDREN.**

\*Maximum initial battery voltage (measured without a workload) is 20 volts. Nominal voltage is 18 volts.



**WEAR CSA APPROVED  
EYE PROTECTION**



**WEAR EAR  
PROTECTION**



**WEAR A  
FACE MASK**

**PRODUCT SPECIFICATIONS**

<b>20V MAX 10" SNOW SHOVEL</b>	
Voltage	20 V
Clearing width	10" / 25.4 cm
Maximum snow intake height	6 <sup>5</sup> / <sub>16</sub> " / 16cm
Maximum throwing distance	20 ' / 6 m
Weight	10 lbs. / 4.5 kg

<b>BATTERY AND CHARGER</b>	
Battery voltage:	20V 2.0 Ah Li-ion (Maximum charged battery voltage, measured without load, is 20V with a nominal value of 18V)
Charger	Up to 70 minutes , Class 2
Replacement battery	5350-547
Replacement charger	DL125418

**Need Assistance?**

Call us on our toll free customer support line:

1-866-349-8665 (Monday through Friday, 9am – 5pm, Eastern Standard Time)

- Technical questions
- Replacement parts
- Parts missing from package

## TABLE OF CONTENTS

Product specifications .....	1
Table of contents .....	2
General safety warnings .....	3-6
Electrical safety .....	3
Work area safety .....	4
Personal safety .....	4-5
Power tool use and care .....	5-6
Service .....	6
Specific safety rules .....	6-7
Clearing a clogged rotor housing .....	7
Maintenance and storage .....	8
Battery and charger safety instructions .....	8-14
Information about the battery .....	10-11
Information about the charger and the charging process .....	11-13
Protection from environmental influences .....	12
Proper care for battery and charger .....	13
Lubricating the cordless snow shovel .....	13
Storage .....	13
Battery and charger off-season storage .....	13-14
Battery caution and disposal .....	14
Battery pack recycling .....	15
Symbols .....	16
Know your 10" snow shovel .....	17
Unpacking .....	18
Assembly and operating .....	18-22
Charging the battery pack .....	18-19
Installing the battery pack in the snow shovel .....	19-20
Connecting the poles .....	20-21
Starting the machine .....	21
Handle adjustment .....	22
Operating tips .....	23
Exploded view .....	24
Parts list .....	25-26
Warranty .....	27

## GENERAL SAFETY WARNINGS

### ALL OPERATORS MUST READ THESE INSTRUCTIONS BEFORE USE

 **WARNING:** Before using this tool or any of its accessories, read this manual and follow all Safety Rules and Operating Instructions. The important precautions, safeguards and instructions appearing in this manual are not meant to cover all possible situations. It must be understood that common sense and caution are factors which cannot be built into the product.

Notice the personal safety alert symbol  used in this manual to draw your attention to a **WARNING** given along with the particular operating instruction. This means that the operation requires special **ATTENTION, CAUTION** and **AWARENESS**.

 **WEAR CSA APPROVED EYE PROTECTION**

 **WEAR A FACE MASK**

 **WEAR EAR PROTECTION**

ALWAYS WEAR EYE PROTECTION THAT CONFORMS WITH CSA REQUIREMENTS or ANSI SAFETY STANDARD Z87.1 FLYING DEBRIS can cause permanent eye damage. Prescription eyeglasses ARE NOT a replacement for proper eye protection.

 **WARNING:** Noncompliant eyewear can cause serious injury if broken during the operation of a power tool.

### ALWAYS WEAR EAR PROTECTION

 **WARNING:** Use hearing protection, particularly during extended periods of operation of the tool, or if the operation is noisy.

### ELECTRICAL SAFETY

 **WARNING:** Use proper circuit protection.

 **WARNING:** Ventilation openings in batteries and chargers must always be open to allow cooling air to circulate freely. Air vents that are blocked, restricted or covered may result in the battery or charger overheating. Overheating may lead to damage to the tool or cause a fire, resulting in possible serious injury.

**READ ALL INSTRUCTIONS BEFORE USING THIS SNOW SHOVEL**

**WORK AREA SAFETY**

Keep work area clean and well lit. Cluttered or dark areas invite accidents.

Do not operate snow shovel in explosive atmospheres, such as in the presence of flammable liquids, gases, or dust. Power tools create sparks which may ignite the dust or fumes.

Keep children and bystanders away while operating a power tool. Distractions can cause you to lose control.

Snow shovel plugs must match the outlet. Never modify the plug in any way. Do not use any adapter plugs with earthed (grounded) snow shovel. Unmodified plugs and matching outlets will reduce risk of electric shock.

Avoid body contact with earthed or grounded surfaces such as pipes, radiators, ranges and refrigerators. There is an increased risk of electric shock if your body is earthed or grounded.

Do not expose the 10" snow shovel to rain or wet locations. Water entering a snow shovel will increase the risk of electric shock.

Do not abuse the cord. Never use the cord for carrying, pulling or unplugging the 10" snow shovel. Keep cord away from heat, oil, sharp edges or moving parts. Damaged or entangled cords increase the risk of electric shock.

When operating a charger outdoors, use an extension cord suitable for outdoor use. Use of a cord suitable for outdoor use reduces the risk of electric shock.

If operating a power tool in a damp location is unavoidable, use a residual current device (RCD) protected supply. Use of a ground fault circuit interrupter (GFCI) reduces the risk of electric shock.

**PERSONAL SAFETY**

Stay alert, watch what you are doing and use common sense when operating a snow shovel. Do not use a snow shovel while you are tired or under the influence of drugs, alcohol or medication. A moment of inattention while operating the snow shovel may result in serious personal injury.

Use personal protective equipment. Always wear eye protection. Protective equipment such as: dust mask, nonskid safety shoes, hard hat, or hearing protection used for appropriate conditions will reduce personal injuries.

**SAVE THESE INSTRUCTIONS FOR REFERENCE**

Prevent unintentional starting. Ensure the switch is in the off-position before connecting to power source and/or battery pack, picking up or carrying the tool. Carrying power tools with your finger on the switch or energizing power tools that have the switch on invites accidents.

Remove any adjusting key or wrench before turning the power tool on. A wrench or a key left attached to a rotating part of the 10" snow shovel may result in personal injury.

Do not overreach. Keep proper footing and balance at all times. This enables better control of the 10" snow shovel in unexpected situations.

Dress properly. Do not wear loose clothing or jewellery. Keep your hair, clothing and gloves away from moving parts. Loose clothes, jewellery or long hair can be caught in moving parts.

If devices are provided for the connection of dust extraction and collection facilities, ensure these are connected and properly used.

### **POWER TOOL USE AND CARE**

Do not force the power tool. Use the correct power tool for your application. The correct power tool will do the job better and safer at the rate for which it was designed.

Do not use the power tool if the switch does not turn it on and off. Any power tool that cannot be controlled with the switch is dangerous and must be repaired.

Disconnect the plug from the power source and/or the battery pack from the power tool before making any adjustments, changing accessories, or storing power tools. Such preventive safety measures reduce the risk of starting the power tool accidentally.

Store idle power tools out of the reach of children and do not allow persons unfamiliar with the power tool or these instructions to operate the power tool. Power tools are dangerous in the hands of untrained users.

Maintain power tools. Check for misalignment or binding of moving parts, breakage of parts and any other condition that may affect the power tool's operation. If damaged, have the power tool repaired before use. Many accidents are caused by poorly maintained power tools.

Keep cutting tools sharp and clean. Properly maintained cutting tools with sharp cutting edges are less likely to bind and are easier to control.

**READ ALL INSTRUCTIONS BEFORE USING THIS SNOW SHOVEL**

Use the power tool, accessories and tool bits etc. in accordance with these instructions, taking into account the working conditions and the work to be performed. Use of the power tool for operations different from those intended could result in a hazardous situation.

Use auxiliary handles supplied with the tool. Loss of control can cause personal injury.

## **SERVICE**

Have your power tool serviced by a qualified repair person using only identical replacement parts. This will ensure that the safety of the power tool is maintained.

## **SPECIFIC SAFETY RULES**

**⚠ WARNING:** Read, understand and follow all instructions on the machine and in the manual before operating this unit. Thoroughly familiarize yourself with the controls and the proper use of the equipment. Know how to stop the unit and disengage the controls quickly.

Children should never be allowed access to the equipment. Adults should never operate the equipment without carefully reading and understanding these instructions.

Keep the area of operation clear of all persons, particularly small children and pets.

Exercise caution to avoid slipping or falling.

Thoroughly inspect the area where the equipment is to be used and remove all doormats, sleds, boards, wires and other foreign objects.

Do not operate the equipment without wearing adequate winter garments. Avoid loose fitting articles of clothing that can become caught in moving parts. Wear footwear that will improve footing on slippery surfaces.

Do not attempt to clear snow from a gravel or crushed rock surface. This product is intended for use only on paved surfaces.

Never attempt to make any adjustments while the motor is running (except when specifically recommended by the manufacturer).

Always wear safety glasses or eye shields during operation or while performing an adjustment or repair to protect your eyes from foreign objects that may be thrown from the machine.

**SAVE THESE INSTRUCTIONS FOR REFERENCE**

Do not put hands or feet near or under rotating parts. Keep clear of the discharge opening at all times.

Exercise extreme caution when operating on or crossing gravel drives, walks or roads. Stay alert for hidden hazards or traffic.

After striking a foreign object, stop the motor. Thoroughly inspect the cordless snow shovel for any damage, and repair the damage before restarting and operating the cordless snow shovel.

If the unit should start to vibrate abnormally, stop the motor and check the unit immediately to ascertain the cause. Vibration is generally a sign of trouble.

Stop the motor and remove the battery whenever you leave the operating position, when transporting the unit, before unclogging the rotor blade housing and when making any repairs, adjustments or inspections to the unit.

When cleaning, repairing or inspecting the cordless snow shovel, make sure that all moving parts have come to a complete stop before beginning work.

Exercise extreme caution when operating on slopes.

Never operate the cordless snow shovel without proper guards and other safety devices in place and in proper working order.

Never direct the discharge toward people or areas where property damage can occur. Keep children, pets and other bystanders away from the work area.

Do not overload the machine capacity by attempting to clear snow at too fast a rate.

Look behind and use care when backing up with the cordless snow shovel.

Never operate the cordless snow shovel without good visibility or light. Always be sure of your footing, and keep a firm hold on the handles. Walk, never run, with the unit.



### **WARNING: CLEARING A CLOGGED ROTOR HOUSING**

Hand contact with the rotating rotor blades inside the rotor housing is the most common cause of injury associated with cordless snow shovels. Never use your hands to clear a clogged rotor housing.

#### **To clear the rotor housing:**

- Shut the motor off and remove the battery.
- Wait 10 seconds to be sure the rotor blades have come to a complete stop.
- Always use a clean-out tool, not your hands, to free the rotating blades.

**READ ALL INSTRUCTIONS BEFORE USING THIS SNOW SHOVEL**



## MAINTENANCE AND STORAGE

Check all fasteners at frequent intervals for proper tightness to ensure that the equipment is in safe working condition.

Always refer to the operator's manual for important details, such as how to properly store your cordless snow shovel for an extended period of time.

Maintain or replace safety and instruction labels as needed.

Run the machine a few minutes after throwing snow to prevent the rotor blades from freezing.

## BATTERY AND CHARGER SAFETY INSTRUCTIONS

**IMPORTANT!** Analyses confirm that incorrect use and poor care of high-performance batteries are the main factors responsible for personal and/or product damage.

**⚠ WARNING!** Use only approved replacement batteries; other batteries may damage the cordless snow shovel and cause it to malfunction, which can lead to serious personal injury.

**⚠ WARNING!** Do not use a battery pack or appliance that is damaged or modified. Damaged or modified batteries may exhibit unpredictable behavior resulting in fire, explosion or risk of injury.

Do not modify or attempt to repair the appliance or the battery pack except as indicated in the instructions for use and care.

Have your battery pack serviced by a qualified repair person using only identical replacement parts. This will ensure that the safety of the battery pack is maintained.

**⚠ CAUTION!** To reduce the risk of injury, charge the 20V lithium-ion battery pack only in its designated lithium-ion charger. Other types of chargers present risk of fire, personal injury and damage. Do not wire a battery pack to a power supply plug or car cigarette lighter. Such misuse will permanently disable or damage the battery pack.

**Avoid dangerous environments** – Do not charge the battery pack in rain, snow or in damp or wet locations. Do not use the battery pack or charger in the presence of explosive atmospheres (gaseous fumes, dust or flammable materials) because sparks may be generated when inserting or removing the battery pack, which could lead to a fire.

**SAVE THESE INSTRUCTIONS FOR REFERENCE**

**Charge in a well-ventilated area** – Do not block the charger vents. Keep them clear to allow for proper ventilation. Do not allow smoking or open flames near a charging battery pack. Vented gases may explode.

NOTE: The safe temperature range for the battery is 41°F – 105°F / 5°C – 40.5°C. Do not charge the battery outside in freezing weather; charge it at room temperature.

**Maintain charger cord** – When unplugging the charger, pull the plug, not the cord, from the receptacle to reduce the risk of damage to the electrical plug and cord. Never carry the charger by its cord or yank it by the cord to disconnect it from the receptacle. Keep the cord away from heat, oil and sharp edges. Make sure the cord will not be stepped on, tripped over or subjected to damage or stress when the charger is in use. Do not use the charger with a damaged cord or plug. Replace a damaged charger immediately.

**Do not use an extension cord unless it is absolutely necessary** – Using the wrong, damaged or improperly wired extension cord poses a risk of fire and electric shock. If an extension cord must be used, plug the charger into a properly wired 16 gauge or larger extension cord with the female plug matching the male plug on the charger. Make sure that the extension cord is in good electrical condition.

**Charger is rated for 120 volt AC only** – The charger must be plugged into an appropriate receptacle.

**Use only recommended attachments** – Use of an attachment not recommended or sold by the battery charger or battery pack manufacturer may result in risk of fire, electric shock or personal injury.

**Unplug charger when not in use** – Make sure to remove battery packs from unplugged chargers.

 **WARNING!** To reduce the risk of electric shock, always unplug the charger before performing any cleaning or maintenance. Do not allow water to flow into the charger. Use a Ground Fault Circuit Interrupter (GFCI) to reduce shock hazards.

**Do not burn or incinerate battery packs** – Battery packs may explode, causing personal injury or damage. Toxic fumes and materials are created when battery packs are burned.

**READ ALL INSTRUCTIONS BEFORE USING THIS SNOW SHOVEL**

**Do not crush, drop or damage battery packs** – Do not use the battery pack or charger if they have sustained a sharp blow, been dropped, run over or have been damaged in any way (i.e. pierced with a nail, hit with a hammer, stepped on, etc.).

**Do not disassemble** – Incorrect reassembly may pose a serious risk of electric shock, fire or exposure to toxic battery chemicals.

**Battery chemicals cause serious burns** – Never let a damaged battery pack contact the skin, eyes or mouth. If a damaged battery pack leaks battery chemicals, use rubber or neoprene gloves to safely dispose of it. If skin is exposed to battery fluids, wash the affected area with soap and water and rinse with vinegar. If eyes are exposed to battery chemicals, immediately flush with water for 20 minutes and seek medical attention. Remove and dispose of contaminated clothing.

**Do not short circuit** – A battery pack will short circuit if a metal object makes a connection between the positive and negative contacts on the battery pack. Do not place a battery pack near anything that may cause a short circuit, such as paper clips, coins, keys, screws, nails and other metallic objects. A short-circuited battery pack poses a risk of fire and severe personal injury.

**Store your battery pack and charger in a cool, dry place** – Do not store the battery pack or charger where temperatures may exceed 105°F / 40.5°C, such as in direct sunlight or inside a vehicle or metal building during the summer.

#### **INFORMATION ABOUT THE BATTERY**

1. The battery pack supplied with your cordless snow shovel is only partially charged. The battery pack has to be charged completely before you use the tool for the first time.
2. For optimum battery performance, avoid low discharge cycles by charging the battery pack frequently.
3. Store the battery pack in a cool place, ideally at 77°F / 25°C and charged to at least 40%.
4. Lithium-ion batteries are subject to a natural aging process. The battery pack must be replaced at the latest when its capacity falls to just 80% of its capacity when new. Weakened cells in an aged battery pack are no longer capable of meeting the high power requirements needed for the proper operation of your snow shovel, and therefore pose a safety risk.
5. Do not throw battery packs into an open fire as this poses a risk of explosion.
6. Do not ignite the battery pack or expose it to fire.

**SAVE THESE INSTRUCTIONS FOR REFERENCE**

7. Do not exhaustively discharge batteries. Exhaustive discharge will damage the battery cells. The most common cause of exhaustive discharge is lengthy storage or nonuse of partially discharged batteries. Stop working as soon as the performance of the battery falls noticeably or the electronic protection system triggers. Place the battery pack in storage only after it has been fully charged.
8. Protect batteries and the tool from overloads. Overloads will quickly result in overheating and cell damage inside the battery housing even if this overheating is not apparent externally.
9. Avoid damage and shocks. Immediately replace batteries that have been dropped from a height of more than one meter or those that have been exposed to violent shocks, even if the housing of the battery pack appears to be undamaged. The battery cells inside the battery may have suffered serious damage. In such instances, please read the waste disposal information for proper battery disposal.
10. If the battery pack suffers overloading and overheating, the integrated protective cutoff will switch off the equipment for safety reasons.  
**IMPORTANT!** Do not press the ON/OFF switch anymore if the protective cut off has been activated. This may damage the battery pack.
11. Use only original battery packs. The use of other batteries poses a fire risk and may result in injuries or an explosion.

#### **INFORMATION ABOUT THE CHARGER AND THE CHARGING PROCESS**

1. Please check the data marked on the rating plate of the battery charger. Be sure to connect the battery charger to a power supply with the voltage marked on the rating plate. Never connect it to a different charger voltage.
2. Protect the battery charger and its cord from damage. Keep the charger and its cord away from heat, oil and sharp edges.
3. Electrical plugs must match the outlet. Never modify the plug in any way. Do not use any adapter plugs with grounded appliances. Unmodified plugs and matching outlets will reduce the risk of electric shock.
4. Keep the battery charger, battery pack(s) and the cordless tool out of the reach of children.
5. Do not use the supplied battery charger to charge other Radley cordless tools unless indicated as compatible by the manufacturer.
6. During periods of heavy use, the battery pack will become warm. Allow the battery pack to cool to room temperature before inserting it into the charger to recharge.

**READ ALL INSTRUCTIONS BEFORE USING THIS SNOW SHOVEL**

7. Do not overcharge batteries. Do not exceed the maximum charging times. These charging times only apply to discharged batteries. Frequent insertion of a charged or partially charged battery pack will result in overcharging and cell damage. Do not leave batteries in the charger for days on end.
8. Never use or charge batteries if you suspect that it has been more than 12 months since the last time they were charged. There is a high probability that the battery pack has already suffered dangerous damage (exhaustive discharge).
9. Charging batteries at a temperature below 41°F / 5°C will cause chemical damage to the cells and may cause a fire.
10. Do not use batteries that have been exposed to heat during the charging process, as the battery cells may have suffered dangerous damage.
11. Do not use batteries that have suffered curvature or deformation during the charging process or those that exhibit other atypical symptoms (gassing, hissing, cracking, etc.).
12. Never fully discharge the battery pack (maximum recommended depth of discharge is 80%). A complete discharge of the battery pack will lead to premature aging of the battery cells.

### **PROTECTION FROM ENVIRONMENTAL INFLUENCES**

1. Wear suitable work clothes. Wear safety goggles.
2. Protect your cordless tool and the battery charger from moisture and rain. Moisture and rain can cause dangerous cell damage.
3. Do not use the cordless tool or the battery charger near vapors and flammable liquids.
4. Do not keep the battery charger in places where the temperature is liable to reach over 105°F / 40.5°C. In particular, do not leave the battery charger in a car that is parked in the sunshine.
5. Protect batteries from overheating. Overloads, overcharging and exposure to direct sunlight will result in overheating and cell damage. Never charge or work with batteries that have been overheated – replace them immediately, if possible.
6. Store the charger and your cordless tool only in dry locations with an ambient temperature of 41°F – 105°F / 5°C – 40.5°C. Store your lithium-ion battery pack in a cool, dry place at a temperature of 77°F / 25°C. Protect the battery pack, charger and cordless tool from humidity and direct sunlight. Only place fully charged batteries in storage (charged to at least 40%).
7. Prevent the lithium-ion battery pack from freezing. Battery packs that were stored below 32°F / 0°C for more than 60 minutes must be discarded.

**SAVE THESE INSTRUCTIONS FOR REFERENCE**

## **PROPER CARE FOR BATTERY AND CHARGER**

**⚠ WARNING!** To reduce the risk of injury, always unplug the charger and remove the battery pack from the charger before performing any maintenance task.

1. To reduce the risk of injury and damage, never immerse your battery pack or charger in liquid or allow any liquid to flow inside these components.
2. Clean out dust and debris from charger vents and electrical contacts by blowing with compressed air.
3. Use only mild soap on a damp cloth to clean the battery pack and charger, keeping away from all electrical contacts. Certain cleaning agents and solvents are harmful to plastics and other insulated parts. Some of these include gasoline, turpentine, lacquer thinner, paint thinner, chlorinated cleaning solvents, ammonia and household detergents containing ammonia. Never use flammable or combustible solvents around battery packs, battery chargers or tools.
4. The lithium-ion battery charger has no serviceable parts.

## **LUBRICATING THE SNOW SHOVEL**

This cordless snow shovel does not need lubrication. All bearings are lubricated at the factory for the life of the product.

## **STORAGE**

1. Examine the cordless snow shovel thoroughly for worn, loose or damaged parts. Should you need to repair or replace a part, contact 1-866-349-8665 for assistance.
2. Remove the battery from the cordless snow shovel before storing.
3. Store the cordless snow shovel indoors in a locked, dry place out of the reach of children to prevent unauthorized use or damage.

## **BATTERY AND CHARGER OFF-SEASON STORAGE**

1. Do not expose your battery pack or charger to water, rain or allow them to get wet. This could permanently damage the charger and the battery pack. Do not use oil or solvents to clean or lubricate your battery pack as the plastic casing can become brittle and crack, causing a serious risk of injury.

**READ ALL INSTRUCTIONS BEFORE USING THIS SNOW SHOVEL**

2. Store the battery pack and charger at room temperature away from moisture. Do not store in damp locations where corrosion of terminals may occur. As with other battery pack types, permanent capacity loss can result if the pack is stored for long periods of time at high temperatures over 105° F / 40.5° C.
3. Lithium-ion battery packs maintain their charge during storage longer than other battery pack types. As a general practice, it is best to unplug the battery charger and remove the battery pack when they are not in use. Recharge the battery pack every 6 months to 50% capacity (2 lights on) during off-season storage to maintain optimal battery performance.

### **BATTERY CAUTION + DISPOSAL**

Always dispose of your battery pack according to federal, provincial, and local regulations. Contact a recycling agency in your area for recycling locations.

**⚠ CAUTION!** Even discharged battery packs contain some energy. Before disposing, use electrical tape to cover the terminals to prevent the battery pack from shorting, which could cause a fire or explosion.

**⚠ WARNING!** To reduce the risk of injury or explosion, never burn or incinerate a battery pack even if it is damaged, dead or completely discharged. When burned, toxic fumes and materials are emitted into the surrounding atmosphere.

1. Batteries vary according to device. Consult your manual for specific information.
2. Install only new batteries of the same type in your product (where applicable).
3. Failure to insert batteries in the correct polarity, as indicated in the battery compartment or manual, may shorten the life of the batteries or cause batteries to leak.
4. Do not mix old and new batteries.
5. Do not dispose of batteries in fire.
6. Batteries should be recycled or disposed of as per provincial and local guidelines.

**SAVE THESE INSTRUCTIONS FOR REFERENCE**

## BATTERY PACK RECYCLING















**To preserve our natural resources, please recycle or dispose of batteries properly.** The batteries charged by this charger may contain chemicals and metals that are harmful to the environment. Never dispose of rechargeable batteries in your normal household garbage or in landfill sites as they will add to the pollution of the environment.





## SYMBOLS

The following table depicts and describes safety symbols that may appear on this product. Read, understand and follow all instructions on the machine before attempting to assemble and operate.

	READ THE OPERATOR'S MANUAL(S) – Read, understand and follow all instructions in the user manual(s) before attempting to assemble and operate.		WARNING! Do not expose the unit to rain or wet conditions. Keep dry.
	SAFETY ALERT – Indicates a precaution, a warning or a danger.		DANGER! Cutting/dismemberment hazard - Keep feet away from the rotating auger.
	Wear hearing protection. Wear eye protection. Wear breathing protection.		CAUTION! Beware of stones and other foreign objects that could be thrown from the appliance.
	Wear safety gloves during use to protect hands.		Wear safety footwear at all times to provide protection against objects that may accidentally fall on feet.
	Do not use hands to unclog chute.		DANGER! Cutting/dismemberment hazard - Keep hands away from the rotating auger. Do not use hands to unclog rotor housing. Stop motor before removing debris.
	Keep hands, feet and clothing away from the rotating auger to avoid injury.		Keep bystanders and children a safe distance (at least 11 yd/10 m) away from the work area.
	The rotating part will continuously run for several seconds after you turn off the machine.		Indoor use only. Only use battery charger indoors.



This symbol designates that this tool is listed with Canadian and U.S. requirements by cSUDus Testing Laboratories, Inc.

UL1090 C22.2 NO. 147-15

Fig. 2

### KNOW YOUR 10" SNOW SHOVEL

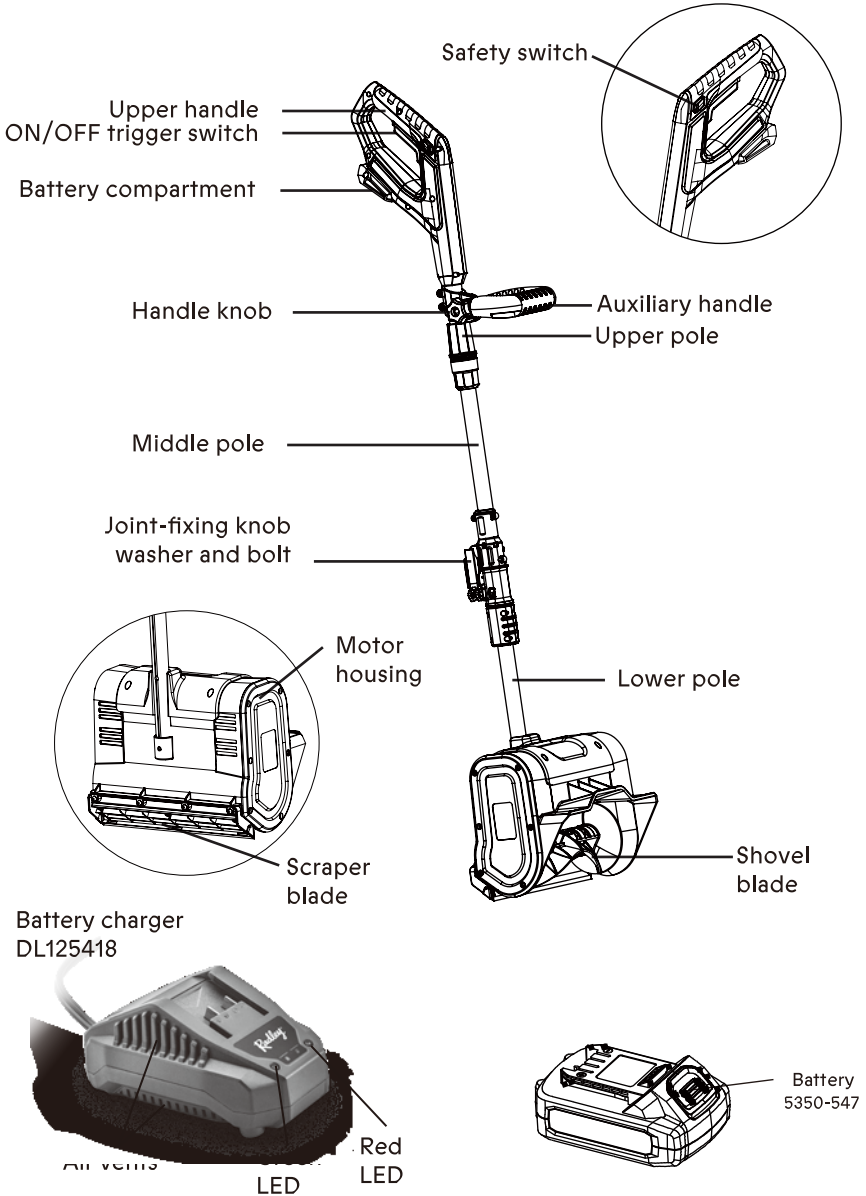

## UNPACKING

**⚠ Caution!** This packaging contains sharp objects. Take care when unpacking. Remove the machine, together with the accessories supplied, from the packaging. Check carefully to ensure that the machine is in good condition and account for any accessories listed in this manual. Make sure that all the accessories are complete. If any parts are found to be missing, the machine and its accessories should be returned together in their original packaging to the retailer.

Do not throw the packaging away, keep it safe throughout the guarantee period, then recycle if possible, otherwise dispose of it by the proper means. Do not let children play with empty plastic bags due to the risk of suffocation.

## CHECKING THE BATTERY CHARGE STATUS

The level of charge remaining in the battery can be checked by using the battery LED power indicator that is contained on the end of the battery.

**NOTE:** The battery charge remaining may be checked while the battery is installed in the tool with the ON/OFF switch turned OFF. It may also be checked while the battery is removed from the tool. DO NOT check the battery charge remaining while the battery is in the charger. You will get a false reading and you may also damage the battery status system.

1. Press and hold the battery status button located on the end of the battery
2. One or more of the three LED lights in the LED window will come ON to indicate the amount of charge that is remaining in the battery as follows:

1 light (Red light ON)	2 lights (Red and Orange light ON)	3 lights (Red/Orange/Green ON)
1/3 or less	1/3 - 2/3	2/3-Fully charged



3. Release the battery status button to turn the LED's OFF.

## ASSEMBLY AND OPERATING

### CHARGING THE BATTERY PACK

1. Place the battery charger (1) in a dry location near a 110–120V 60 Hz electrical outlet (Fig. 2).
2. Plug the battery charger into the outlet and make sure the green LED indicator light (5) comes ON. If it does not, refer to the chart (Fig. 3) to identify the problem.
3. Turn the battery (2) upside down and slide it onto the charger.  
**NOTE:** Make sure the grooves (3) in the sides of the battery slide over the matching tabs on the charger (4) until the battery latch 'clicks' into place.

### NOTES:

1. When the charger is plugged into the wall receptacle and NO battery is on the charger, the green indicator light (5) will turn ON indicating the charger is "live".
2. When a discharged battery is installed on the charger, the green indicator light will turn OFF and the red indicator light (6) will turn ON. The red indicator light indicates the battery is being charged.
3. If the red indicator light does not come ON, check to make sure charger pack is slid fully onto the battery and the electrical outlet is working properly.
4. See Fig. 3 below for other indicator light functions.
5. A discharged battery pack should be fully charged in approximately 70 minutes.
6. It is normal for the battery charger to hum and be warm to the touch during operation.
7. If the battery pack does not charge properly, check to make sure the electrical outlet is "live".
8. Do NOT charge batteries when the work area or the battery temperature is at or below 5°C / 41° F or above 40.5°C / 105° F.

Fig. 3



Fig. 2

Green Light	Red Light	Battery Inserted Into Charger	Charging Status
ON	OFF	NO	Charger connected to power supply.
OFF	ON	YES	Battery being charged.
ON	OFF	YES	Battery fully charged.
ON	OFF	YES	Battery is charged but not operational on tool. This may indicate defective / bad contact on battery or charging conditions are either too hot or too cold.

### INSTALLING THE BATTERY PACK IN THE SNOW SHOVEL

1. Remove the discharged battery pack (1) from the tool by pressing the battery release button (2) on the rear of the battery downward (Fig. 4) and pulling the battery pack out of the tool handle (3) (Fig. 5).

2. Insert the fully charged battery pack into the matching slots in the rear of the tool handle where the discharged battery pack has been removed.

**NOTE:** The battery release button will "click" into place when the battery pack is fully installed.

**⚠ WARNING: Do not immerse battery pack in water. Sudden cooling could cause a hot battery to explode or leak.**

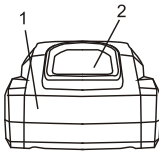

Fig. 4

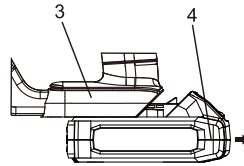

Fig. 5

## ASSEMBLY

**⚠ WARNING!** To prevent accidental starting that could cause serious personal injury, always remove the battery pack from the product when assembling parts.

### CONNECTING THE POLES

Slide the middle pole into the lower pole assembly and the upper pole assembly. Align the screw holes (Fig. 6).

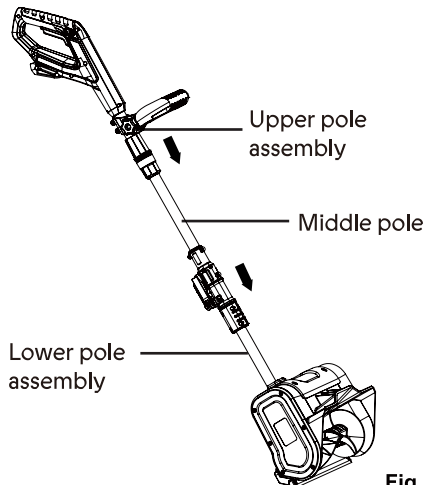
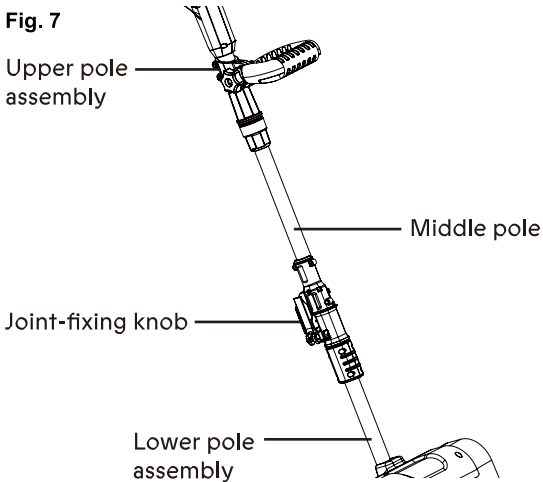

Fig. 6

Insert the joint-fixing knobs through the aligned holes in the poles and secure the other end with the washers and the joint-fixing knobs (Fig. 7).

**NOTE:** You may have to carefully move the wiring inside the tube to one side if it blocks the path of the bolt.

Fig. 7



### STARTING THE MACHINE

To start the cordless snow shovel, push and hold the safety lock switch on the side of the handle grip with your thumb and then squeeze the trigger switch with your fingers. Once the machine powers on, you can release the safety lock switch and proceed with operation (Fig. 8).

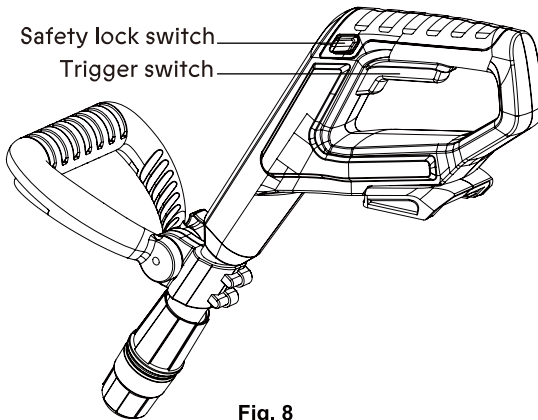

To stop the cordless snow shovel, release the trigger switch.

### HANDLE ADJUSTMENT

To adjust the angle of the auxiliary handle, follow the instructions below:

1. Stop the machine and remove the battery. Wait until the blade comes to a complete stop.
2. Loosen the auxiliary handle by turning the handle knob counterclockwise. Rotate the auxiliary handle to a comfortable position (Fig. 9).

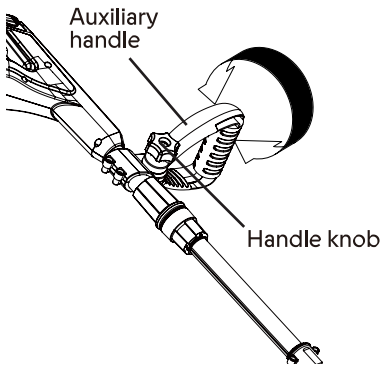

Fig. 9

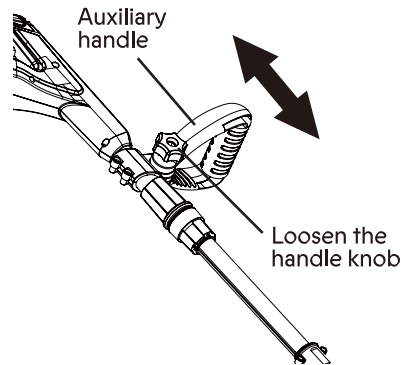

Fig. 10

3. Fix the handle by tightening the handle knob. Insert the battery and resume working.

To adjust the location of the auxiliary handle, follow the instructions below:

1. Stop the machine and remove the battery. Wait until the blade comes to a complete stop.
2. Loosen handle knob slightly and slide auxiliary handle as needed to desired location. Retighten handle knob securely (Fig. 10). Insert the battery and resume working.

**NOTE:** In order to prevent the auxiliary handle from moving around or sliding on the pole, be sure to tighten securely.

**OPERATING TIPS**

- Start the cordless snow shovel. Push the shovel forward at a comfortable rate, yet slow enough to clear the path completely. The clearing width of the snow shovel and the depth of snowfall should dictate your forward speed.
- Direct the snow discharge to the right or to the left by holding the cordless snow shovel at a slight angle.
- To remove snow most efficiently, throw the snow downwind and slightly overlap each swath.
- This cordless snow shovel cuts a path 10" /25.4 cm wide and up to 6 ¼" /16cm deep.
- When clearing deeper drifts, hold the cordless snow shovel by the upper and lower handles and use a swinging or sweeping motion. Remove up to 6 ¼" /16 cm.
- Remove the battery after using the cordless snow shovel. Hang the shovel so it will not be misplaced or damaged.



## EXPLODED VIEW

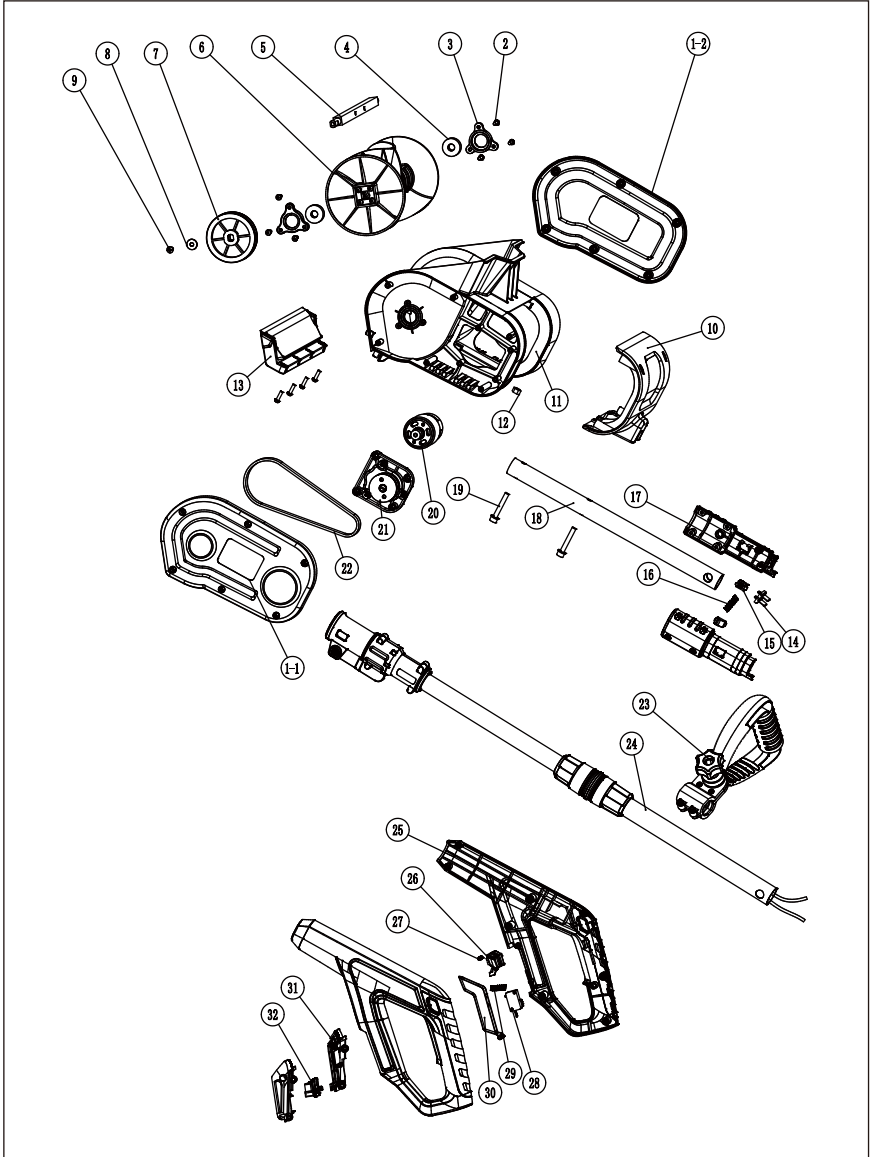

## PARTS LIST

**⚠ WARNING:** When servicing, use only original equipment replacement parts. The use of any other parts may create a safety hazard or cause damage to the 10" snow shovel.

Any attempt to repair or replace electrical parts on this 10" snow shovel may create a safety hazard unless repairs are performed by a qualified technician. For more information, call the Toll-free Helpline, at 1-866-349-8665 – Monday-Friday from 9am - 5pm Eastern Standard Time.

Always order by key number.

Key #	Part Name	Quantity
1-1	Hood	1
1-2	Hood	1
2	Tapping screw	3
3	Bearing cap	2
4	Bearing	2
5	Shaft	1
6	Snow blade	1
7	Wheel	1
8	Washer	1
9	Screw	1
10	Top cover	1
11	Housing	1
12	Nut	2
13	Shovel snow assembly	1
14	Insert seat	1
15	Button assembly	1
16	Button spring	1
17	Housing handle assembly	1
18	Aluminum pipe	1
19	Screw	2
20	Motor assembly	1
21	Gearbox assembly	1
22	Belt	1
23	Sub handle assembly	1
24	Aluminum pipe assembly	1
25	Handle housing assembly	1
26	Lock button switch	1
27	Spring	1
28	Switch	1
29	Spring	1

Key #	Part Name	Quantity
30	Switch button	1
31	Battery interface assembly	1
32	Plug socket	1



## **WARRANTY**

### **RADLEY 20V MAX 10" SNOW SHOVEL WARRANTY**

If this Radley tool fails due to a defect in material or workmanship within three years from the date of purchase, return it to any Home Hardware store with the original bill of sale for exchange. This warranty does not include expendable parts including but not limited to blades, brushes, belts, light bulbs and/or batteries. This warranty covers defects in material or workmanship only. It does not cover normal wear and tear, failure due to abuse/misuse, or defects caused by careless or accidental mishandling. If this Radley product is used for commercial or rental purposes, this warranty does not apply.

20V Max\*

# Snow Shovel

10"/25 cm  
clearing width



3 Year *limited*  
warranty

Radley®

EXCLUSIVE TO HOME HARDWARE

For information on the entire line-up of Radley power  
tools visit [homehardware.ca](http://homehardware.ca) or your local Home Hardware retail store.

MADE IN CHINA / FABRIQUÉ EN CHINE  
HOME HARDWARE STORES LIMITED  
ST. JACOBS, ONTARIO N0B 2N0  
ORDER ONLINE / COMMANDE EN LIGNE  
[homehardware.ca](http://homehardware.ca)

© 06 / 2020 Home Hardware Stores Limited



5554-022