

Radley®

20V Max* Cordless Drill

Owner's Manual:

2 Batterie 2 Variable Speeds

< 60 Minute
fast charging

3 Year limited warranty (for tool)
and 2 year limited warranty
(for the battery and charger).



JD6322

**READ ALL INSTRUCTIONS BEFORE FIRST USE.
KEEP THIS MANUAL FOR FUTURE REFERENCE.
KEEP AWAY FROM CHILDREN.**

*Maximum initial battery voltage (measured without a workload)
is 20 volts. Normal voltage is 18 volts.



**WEAR CSA APPROVED
EYE PROTECTION**



**WEAR EAR
PROTECTION**



**WEAR A
FACE MASK**

PRODUCT SPECIFICATIONS

20V MAX CORDLESS DRILL	
Variable chuck speed	0–400 RPM / 0–1,400 RPM(no load)
Torque clutch positions	19 + 1 Drill mode
Keyless chuck	3/8" Single sleeve
Maximum drilling capacity	1/4" In metal 3/4" in wood
Weight	2 lb. 16 oz. (1.352 kg)

BATTERY AND CHARGER	
Battery	20 V Max*Li-ion (Maximum charged battery voltage, measured without load, is 20V with a nominal value of 18V), 1.5 Ah
Charger	Approximately 1 hour , Class 2
Replacement battery	5350-547
Replacement charger assembly	DL125418

Need Assistance?

Call us on our toll free customer support line:

1-866-349-8665 (Monday through Friday 9am – 5pm eastern time)

- Technical questions
- Replacement parts
- Parts missing from package



TABLE OF CONTENTS

Product specifications	1
Table of contents	2
General safety warnings	3
Eye, ear & lung protection	3
Electrical safety	4
Power tool safety	4–6
Work area safety	4
Personal safety	5
Power tool use and care	5–6
Battery tool use and care	6
Service	6
Specific safety rules	7–8
Battery & charger safety	8–9
Battery pack recycling	9
Symbols	10
Know your cordless drill & battery	11
Assembly and operating	12–18
Charging the battery pack	12
Installing a battery on the drill	13
Adjusting the torque	13
Forward/reverse switch	14
Variable-speed trigger switch	14
LED worklight	14
Two speed gear box switch	14
Installing drill bits	15
Removing bits	15
Drilling	16
Driving screws	17
Removing the chuck	17
Retightening a loose chuck	18
Maintenance	18–19
Battery performance	19
Battery maintenance	19
Battery pack removal and preparation for recycling	19
Exploded view	20
Parts list	21
Warranty	22



GENERAL SAFETY WARNINGS

WARNING: Before using this tool or any of its accessories, read this manual and follow all Safety Rules and Operating Instructions. The important precautions, safeguards and instructions appearing in this manual are not meant to cover all possible situations. It must be understood that common sense and caution are factors which cannot be built into the product.

This instruction manual includes the following:

- General Safety Warnings
- Specific Safety Rules and Symbols
- Functional Description
- Assembly
- Operation
- Maintenance
- Accessories

EYE, EAR & LUNG PROTECTION



WEAR CSA APPROVED EYE PROTECTION



WEAR EAR PROTECTION



WEAR A FACE MASK

ALWAYS WEAR EYE PROTECTION THAT CONFORMS WITH CSA REQUIREMENTS or ANSI SAFETY STANDARD Z87.1

FLYING DEBRIS can cause permanent eye damage. Prescription eyeglasses ARE NOT a replacement for proper eye protection. **WARNING:** Non-compliant eyewear can cause serious injury if broken during the operation of a power tool.

ALWAYS WEAR EAR PROTECTION



WARNING: Use hearing protection, particularly during extended periods of operation of the tool, or if the operation is noisy.

WEAR A DUST MASK THAT IS DESIGNED TO BE USED WHEN OPERATING A POWER TOOL IN A DUSTY ENVIRONMENT.



WARNING: Dust that is created by power sanding, sawing, grinding, drilling, and other construction activities may contain chemicals that are known to cause cancer, birth defects, or other genetic abnormalities. These chemicals include: Lead from lead-based paints; Crystalline silica from bricks, cement, and other masonry products; Arsenic and chromium from chemically treated lumber. The level of risk from exposure to these chemicals varies, according to how often this type of work is performed. In order to reduce exposure to these chemicals, work in a well-ventilated area, and use approved safety equipment, such as a dust mask that is specifically designed to filter out microscopic particles.

ELECTRICAL SAFETY



WARNING: To avoid electrical hazards, fire hazards or damage to the tool, use proper circuit protection.



WARNING: Ventilation openings in batteries and chargers must always be open to allow cooling air to circulate freely. Air vents that are blocked, restricted or covered may result in the battery or charger overheating. Overheating may lead to damage to the tool or cause a fire, resulting in possible serious injury.

POWER TOOL SAFETY

WORK AREA SAFETY

Keep work area clean and well lit. Do not operate power tools in the presence of flammable liquids, gases or dust. Power tools create sparks which may ignite the dust or fumes. **Keep children and bystanders away while operating a power tool.** Distractions can cause you to lose control.

Power tool plugs must match the outlet. Never modify the plug in any way. Do not use any adapter plugs with earthed (grounded) power tools. Unmodified plugs and matching outlets will reduce risk of electric shock.

Avoid body contact with earthed or grounded surfaces such as pipes, radiators, ranges and refrigerators. There is an increased risk of electric shock if your body is earthed or grounded.

Do not expose power tools to rain or wet conditions. Water entering a power tool will increase the risk of electric shock.

Never use the cord for carrying, pulling or unplugging the power tool. Keep cord away from heat, oil, sharp edges or moving parts. Do not use a damaged or tangled cord.

When operating a power tool outdoors, use an extension cord suitable for outdoor use. If operating a power tool in a damp location is unavoidable, use a residual current device (RCD) protected supply. Use of a ground fault circuit interrupter (GFCI) reduces the risk of electric shock.

PERSONAL SAFETY

Stay alert, watch what you are doing and use common sense when operating a power tool. Do not use a power tool while you are tired or under the influence of drugs, alcohol or medication. A moment of inattention while operating power tools may result in serious personal injury.

Use personal protective equipment. Always wear eye protection. Protective equipment such as dust mask, non-skid safety shoes, hard hat, or hearing protection used for appropriate conditions will reduce personal injuries.

Ensure the switch is in the off-position before connecting to power source and/or battery pack, picking up or carrying the tool. Carrying power tools with your finger on the switch or energizing power tools that have the switch on invites accidents.

Remove adjusting key or wrench before turning the power tool on.

Do not overreach. Keep proper footing and balance at all times. This enables better control of the power tool in unexpected situations.

Do not wear loose clothing or jewellery. Keep your hair, clothing and gloves away from moving parts. Loose clothes, jewellery or long hair can be caught in moving parts.

Connect dust extraction and collection facilities, ensure these are connected and properly used. Use of dust collection can reduce dust-related hazards.

POWER TOOL USE AND CARE

Do not force the power tool. Use the correct power tool for your application. The correct power tool will do the job better and safer at the rate for which it was designed.

Do not use the power tool if the switch does not turn it on and off. Any power tool that cannot be controlled with the switch is dangerous and must be repaired.

Disconnect the plug from the power source and/or the battery pack from the power tool before making any adjustments, changing accessories, or storing power tools. Such preventive safety measures reduce the risk of starting the power tool accidentally.

Store idle power tools out of the reach of children and do not allow persons unfamiliar with the power tool or these instructions to operate the power tool. Power tools are dangerous in the hands of untrained users.

Maintain power tools. Check for misalignment or binding of moving parts, breakage of parts and any other condition that may affect the power tool's operation. If damaged, have the power tool repaired before use. Many accidents are caused by poorly maintained power tools.

Keep cutting tools sharp and clean. Properly maintained cutting tools with sharp cutting edges are less likely to bind and are easier to control.

Use the power tool, accessories and tool bits etc. in accordance with these instructions, taking into account the working conditions and the work to be performed. Use of the power tool for operations different from those intended could result in a hazardous situation.

Hold power tools by insulated gripping surfaces when performing an operation where the cutting tool or fastener may contact hidden wiring or its own cord. Contact with a live wire will make exposed metal parts of the tool live and shock the operator.

BATTERY TOOL USE AND CARE

Recharge only with the charger specified by the manufacturer. A charger that is suitable for one type of battery pack may create a risk of fire when used with another battery pack.

Use power tools only with specifically designated battery packs. Use of any other battery packs may create a risk of injury and fire.

When battery pack is not in use, keep it away from other metal objects, like paper clips, coins, keys, nails, screws or other small metal objects that can make a connection from one terminal to another. Shorting the battery terminals together may cause burns or a fire.

Under abusive conditions, liquid may be ejected from the battery; avoid contact. If contact accidentally occurs, flush with water. If liquid contacts eyes, flush with water and seek medical help. Liquid ejected from the battery may cause irritation or burns.

SERVICE

Have your power tool serviced by a qualified repair person using only identical replacement parts. This will ensure that the safety of the power tool is maintained.

 **SPECIFIC SAFETY RULES**

WARNING: Know your cordless drill. Do not plug in the charger or install the battery in the tool until you have read and understand this Owner's Manual. Learn the tool's applications and limitations, as well as the specific potential hazards related to this tool. Following this rule will reduce the risk of electric shock, fire, or serious injury.

**WEAR CSA
APPROVED
EYE PROTECTION**

Always wear eye protection. Any power tool can throw foreign objects into your eyes and cause permanent eye damage. **ALWAYS** wear safety goggles (not glasses) that comply with ANSI safety standard Z87.1. Everyday glasses have only impact resistant lenses. They **ARE NOT** safety glasses.



WARNING: Glasses or goggles not in compliance with ANSI Z87.1 could cause serious injury when they break.



WARNING: Always use a safety shield, hearing protection and dust mask when drilling concrete.



WARNING: To avoid fire or toxic reaction, never use gasoline, naphtha, acetone, lacquer thinner or similar highly volatile solvents to clean the tool.



WARNING: Use only accessories that are recommended for this cordless drill. Follow the instructions that accompany the accessories. The use of improper accessories may result in injury to the operator or damage to the tool.



WARNING: If any part is missing or damaged, do not plug the tool into the power source or install any accessory until the missing or damaged part is replaced.

Do not drill material too small to be securely held. Always keep hands out of the path of the drill bit. Avoid awkward hand positions where a sudden slip could cause your hand to move into the path of the drill bit.

Secure the workpiece. Use clamps or a vice to hold the workpiece. It is safer than using your hand and it frees both hands to operate the tool.

Make sure there are no nails or foreign objects in the part of the workpiece to be drilled.

To avoid injury from accidental starting, always remove the battery from the tool before installing or removing a drill bit.

Before starting the operation, jog the drill switch to make sure the drill bit does not wobble or vibrate.

Do not use fly cutters or multiple-part hole cutters, because they can come apart or become unbalanced during use.

Make sure the spindle has come to a complete stop before touching the chuck or attempting to change the drill bit.

Always make sure the chuck is tight and the drill bit firmly tightened in the chuck before starting drill.



BATTERY & CHARGER SAFETY

WARNING: Only use the charger supplied with this kit to charge the 20V Max* Li-ion batteries for this tool. Charging any other batteries may damage the charger and possibly cause serious injury.

Do not store or carry the battery in a manner in which metal objects could contact the exposed metal end. Do not place the battery in aprons, pockets, drawers, etc. with loose nails, screws, keys etc. The battery could short circuit causing a fire, personal injury or damage to the battery.

Never attempt to open the battery for any reason. If the housing of the battery breaks or cracks, immediately discontinue use and do not recharge.

Do not charge the battery if it is wet or shows any evidence of corrosion.

A small leakage from the battery may occur under extreme usage, charging or temperature conditions. This does not indicate a failure. However, if the outer seal is broken and this leakage gets on your skin, follow these steps:

1. Wash immediately with soap and water.
2. Neutralize with a mild acid such as lemon juice or vinegar.
3. If liquid gets into your eyes, flush immediately with clean water for a minimum of 10 minutes and seek medical attention.

NOTE: The battery liquid is slightly acidic.

Do not incinerate the battery. It can explode in a fire.

Do not use an extension cord. Plug the charger cord directly into an electrical outlet.

Use the charger only in a standard 120V, 60 Hz electrical outlet.

Do not use the charger in wet or damp conditions. It is intended for indoor use only. Do not use the charger near sinks or tubs. Do not immerse the charger in water. Do not allow the cord to hang over the edge of a table or counter or touch hot surfaces. The charger should be placed away from sinks and hot surfaces.

Do not use the charger to charge any batteries other than this 20V Max* cordless drill battery. Other batteries may explode.

Do not operate charger if the cord or plug is damaged. Replace the damaged cord and plug immediately.

Do not operate the charger if it has received a sharp blow, been dropped or otherwise damaged in any way. Have a qualified technician examine the charger and repair it if necessary. Do not disassemble the charger.

Do NOT charge the batteries when the work area or the battery temperature is at or below 0° C (32° F) or above 45° C (113° F).

Unplug the charger when not in use and before cleaning or maintenance.



BATTERY PACK RECYCLING











To preserve our natural resources, please recycle or dispose of batteries properly. The batteries charged by this charger may contain chemicals and metals that are harmful to the environment. Never dispose of rechargeable batteries in your normal household garbage or in landfill sites as they will add to the pollution of the environment.



SYMBOLS

WARNING: Some of the following symbols may appear on the drill. Study these symbols and learn their meaning. Proper interpretation of these symbols will allow for more efficient and safer operation of this tool.

V	Volts
A	Amperes
Hz	Hertz
W	Watts
kW	Kilowatts
μ F	Microfarads
L	Liters
kg	Kilograms
H	Hours
N/cm ²	Newtons per square centimeter
Pa	Pascals
OPM	Oscillations per minute
Min	Minutes
S	Seconds
 or a.c.	Alternating current
	3-Phase alternating current
	3-Phase alternating current with neutral

	Direct current
n_0	No load speed
	Alternating or direct current
	Class II construction
	Splash-proof construction
	Watertight construction
	Protective grounding at grounding terminal, Class I tools
.../min	Revolutions or reciprocations per minute
\emptyset	Diameter
0	Off position
	Directional arrow
	Warning symbol
	Wear your safety glasses
	Wear your hearing protection



This symbol designates that this tool is listed with Canadian and U.S. requirements by cTUVus Testing Laboratories, Inc.

UL 62841-1:2015 R4.18 CSA C22.2 No.62841-1:2015+G11+G12

UL 62841-2-1:2018 CSA C22.2.62841-2-1:2018

KNOW YOUR CORDLESS DRILL & BATTERY

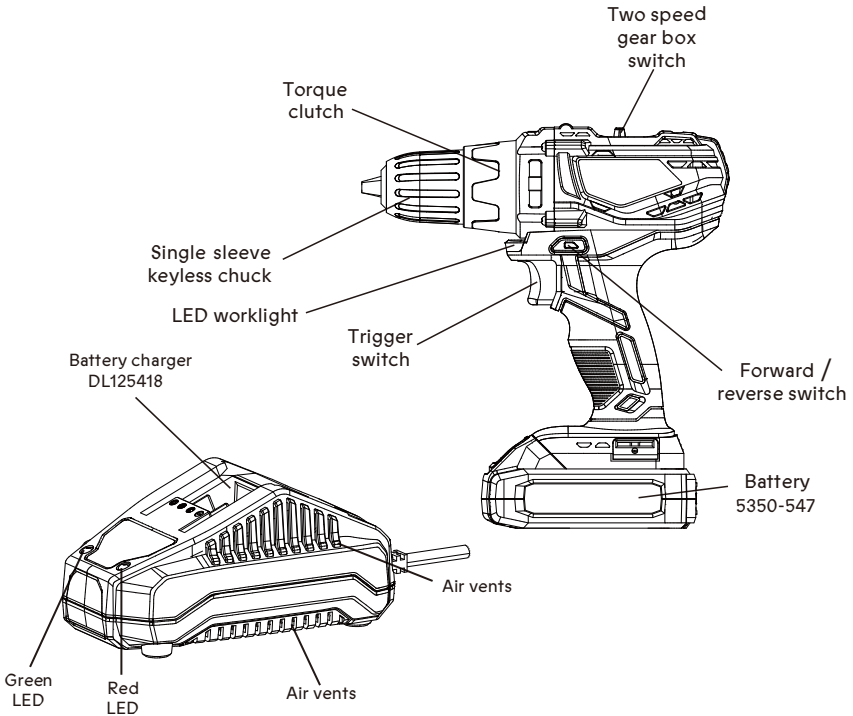

CHECKING THE BATTERY CHARGE STATUS

The level of charge remaining in the battery can be checked by using the battery LED power indicator that is contained on the end of the battery.

NOTE: The battery charge remaining may be checked while the battery is installed in the tool with the ON/OFF switch turned OFF. It may also be checked while the battery is removed from the tool. **DO NOT** check the battery charge remaining while the battery is in the charger. You will get a false reading and you may also damage the battery status system.

1. Press and hold the battery status button located on the end of the battery
2. One or more of the Three LED lights in the LED window will come ON to indicate the amount of charge that is remaining in the battery as follows:

1 light (Red light ON)	2 lights (Red and orange light ON)	3 lights (Red/Orange/Green ON)
1/3 or less	1/3 - 2/3	2/3-Fully charged



3. Release the battery status button to turn the LED's OFF.

ASSEMBLY AND OPERATING

CHARGING THE BATTERY PACK

1. Place the battery charger (1) in a dry location near a 110–120V 60 Hz electrical outlet (Fig. 1).
2. Plug the battery charger into the outlet and make sure the green LED indicator light (5) comes ON. If it does not, refer to the chart (Fig. 2) to identify the problem.
3. Turn the battery (2) upside down and slide it onto the charger.

NOTE: Make sure the grooves (3) in the sides of the battery slide over the matching tabs on the charger (4) until the battery latch “clicks” into place.

NOTES:

1. When the charger is plugged into the wall receptacle and NO battery is on the charger, the green indicator light (5) will turn ON indicating the charger is “live”.
2. When a discharged battery is installed on the charger, the green indicator light will turn OFF and the red indicator light (6) will turn ON. The red indicator light indicates the battery is being charged.
3. If the red indicator light does not come ON, check to make sure battery pack is slid fully onto the charger and the electrical outlet is working properly.
4. See Fig. 2 below for other indicator light functions.
5. A discharged battery pack should be fully charged in <60minutes.
6. It is normal for the battery charger to hum and be warm to the touch during operation.
7. If the battery pack does not charge properly, check to make sure the electrical outlet is “live”.
8. Do NOT charge batteries when the work area or the battery temperature is at or below 0°C / 32° F or above 45°C / 113° F.

Fig. 2

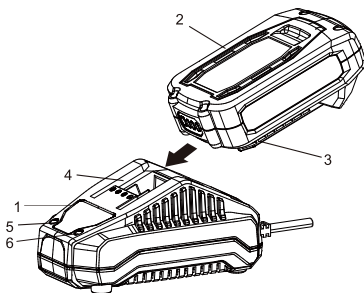

Fig. 1

Green Light	Red Light	Battery Inserted Into Charger	Charging Status
ON	OFF	NO	Charger connected to power supply
OFF	ON	YES	Battery being charged
ON	OFF	YES	Battery fully charged
ON	OFF	YES	Battery is charged but not operational on tool. This may indicate defective / bad contact on battery or charging conditions are either too hot or too cold.

Fig. 2

ASSEMBLY AND OPERATING

INSTALLING A BATTERY ON THE DRILL

1. Remove the discharged battery (1) from the drill by pressing downward on the battery release button (2) and sliding the battery backward until it is removed from the drill handle (3) (Fig. 3).
2. Slide the fully charged battery onto the matching keys (4) in the drill handle where the discharged battery has been removed.

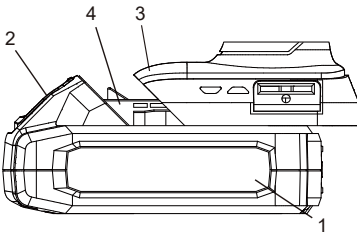

Fig. 3

NOTE: Make sure the slots in the battery are fully engaged with the mounting keys in the drill handle. The battery release button will “click” into place when the battery is fully installed.

WARNING: Do not immerse the battery pack in water. Sudden cooling could cause a hot battery to explode or leak.

ADJUSTING THE TORQUE

1. Your drill is equipped with an adjustable torque clutch for driving different types of screws into different types of materials. It also has a setting for “drilling”. The proper setting depends upon the type of material, the size of screw being used and the function required.

Adjust the torque setting as follows:

1. Identify the torque settings located on the torque adjustment ring (1) (Fig. 4).
2. Rotate adjustment ring to align the correct torque setting number with the torque indicator arrow (2). See below for the correct torque settings:
 - **1-4 For driving small screws.**
 - **5-7 For driving medium sized screws into soft materials.**
 - **8-10 For driving screws into soft & medium-density materials.**
 - **11-13 For driving screws into hardwood.**
 - **14-19 For driving large screws.**
 - **For drilling. This position is marked with a drill bit icon (3) on the torque adjustment ring (Fig. 5).**

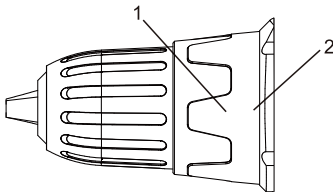

Fig. 4

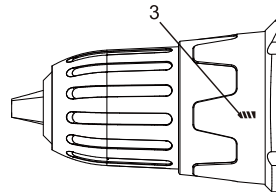

Fig. 5

ASSEMBLY AND OPERATING (continued)

FORWARD / REVERSE SWITCH

The forward/reverse switch (1) is conveniently mounted above the trigger switch (2) (Fig. 6). To make the drill rotate clockwise (for drilling) push the forward/reverse switch to the left. To make the drill rotate counterclockwise for removing screws, push the forward/reverse switch to the right.

NOTES:

- a) Never change the position of the forward/reverse switch while the chuck is turning.
- b) The trigger switch will NOT function with the forward/reverse switch in the middle position.

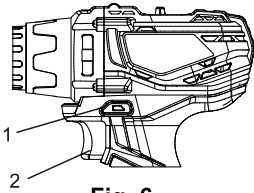

Fig. 6

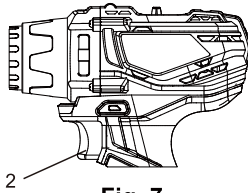

Fig. 7

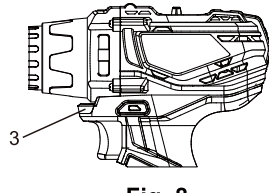

Fig. 8

VARIABLE-SPEED TRIGGER SWITCH

This drill is equipped with a variable-speed ON/OFF trigger switch.

1. To start drill, gently squeeze the trigger switch (2) (Fig. 7).

NOTE: The drill will turn at its slowest speed when the trigger switch is depressed slightly. The drill will turn at its fastest speed when the trigger switch is fully depressed.

2. To stop the drill, release the trigger switch.

NOTE: Drilling at a slow speed for an extended period of time may cause the drill motor or the battery pack to overheat. If either the drill or the battery gets hot, stop drilling and allow them to cool for at least 15 minutes.

LED WORKLIGHT

The LED worklight (3) will automatically turn ON when the trigger switch is squeezed (Fig. 8). It will automatically turn OFF when the trigger switch is released.

TWO-SPEED GEAR BOX SWITCH

The two-speed gear box switch is located on the top of the drill housing. Set the speed-control switch to the desired speed before starting the drill. Slide the speed-control switch FORWARD (Fig. 9a) for low-speed operation. Slide the speed-control switch BACK (Fig. 9b) for high-speed operation.

NOTES:

- Use low-speed setting for drilling large holes and for driving screws.
- Use high-speed setting for drilling smaller holes.
- Do NOT change the speed-control switch position while drill is turned ON. Damage to the gears may result.

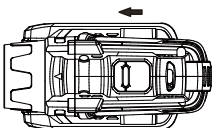

Fig. 9a

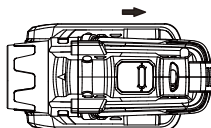

Fig. 9b

ASSEMBLY AND OPERATING (continued)

INSTALLING DRILL BITS

WARNING: Never hold the chuck body with one hand and use the drill power to rotate the drill body to loosen or tighten bits. Serious injury may result.

This drill is equipped with a single sleeve keyless chuck.

1. To open the keyless drill chuck, grasp and hold the chuck collar (1) with one hand (Fig. 10). Rotate the chuck body (2) with the other hand in a counterclockwise direction (3) until the chuck jaws (4) open wide enough to accept the bit (5).
2. Insert the bit into the chuck the full length of the jaws. Raise the front of your drill slightly to prevent the bit from falling out of the chuck jaws.
3. Tighten the chuck jaws onto the bit by turning the chuck body in a clockwise direction. **NOTE:** Make sure the bit is properly aligned in the jaws and NOT at an angle. An improperly aligned bit could be thrown from the chuck when drill is started. Make sure flat sides of the screwdriver bit are being grasped by the chuck jaws.
4. Finish tightening the chuck jaws by holding the chuck collar with one hand and firmly tightening the chuck body by rotating it in a clockwise direction. **NOTE:** Hand tighten the chuck jaws. Do NOT use pliers. You will damage the chuck.

WARNING: Do not insert the drill bit into the chuck and tighten as shown in Fig. 11. The drill bit MUST be properly inserted with all three of the chuck jaws holding the bit centered in the chuck. Failure to properly insert the drill bit could cause the drill bit to be thrown from the chuck, resulting in possible serious injury or damage to the chuck.

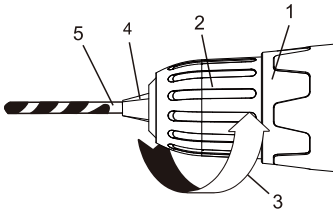

Fig. 10

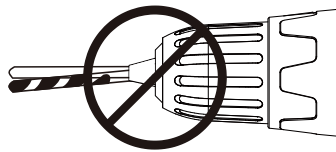

Fig. 11

REMOVING BITS

1. To open the keyless drill chuck, grasp and hold the chuck body and rotate it in a counterclockwise direction until the chuck jaws open wide enough to release the bit.
2. Remove the drill bit.

WARNING: For safety reasons, the operator must read the sections of this Owner's Manual entitled "GENERAL SAFETY WARNINGS", "POWER TOOL SAFETY", "SPECIFIC SAFETY RULES", "BATTERY & CHARGER SAFETY" and "SYMBOLS" before using this cordless drill. Verify the following every time the cordless drill is used:

1. Safety glasses, safety goggles, or face shield is being worn.
2. Hearing protection is being worn.
3. The chuck has not worked loose on the spindle.
4. The bit is in good condition and is properly tightened onto the chuck.

Failure to observe these safety rules will significantly increase the risk of injury.

ASSEMBLY AND OPERATING (continued)

DRILLING

When drilling into smooth, hard surfaces such as metal, use a center punch to mark the desired hole location. This will prevent the drill bit from slipping off center as the hole is started. The workpiece to be drilled should be secured in a vice or with clamps to keep it from turning as the drill bit rotates (Fig. 12).

1. Check the drill bit to make sure it is firmly locked into the drill chuck, and verify that the forward/reverse switch is in the forward position.
2. Set the torque clutch to the drilling position.
3. Hold the drill firmly with both hands whenever possible. Use one hand to grasp the handle and switch.

NOTE: Make sure the hand placed on the body of the drill does not cover the air vents. Covering these air vents will reduce motor cooling, and possibly lead to overheating the motor.

4. While holding the drill firmly, place the point of the drill bit at the point to be drilled. Squeeze the switch trigger to start the drill.

NOTE: Always use a higher drill speed when drilling small holes. Use a slower drill speed when drilling large holes.

5. Move the drill bit into the workpiece applying only enough pressure to keep the bit cutting. Do not force the drill bit or apply sideways pressure to elongate the hole.

WARNING: Be prepared for binding and bit breakthrough. When these situations occur, the drill bit has a tendency to grab the workpiece. This action will kick the drill opposite to the direction of the drill bit rotation, and could cause loss of control when breaking through material as you complete drilling the hole. If you are not prepared, this loss of control can result in serious injury.

When drilling metals, use light oil on the drill bit to keep it from overheating. The oil will prolong the life of the drill bit and improve the cutting action. If the bit jams in the workpiece, or if the drill stalls, release the trigger switch immediately. Remove the bit from the workpiece and determine the reason for jamming.

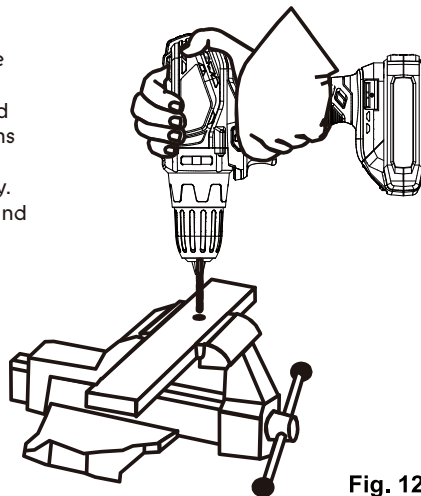

Fig. 12

ASSEMBLY AND OPERATING (continued)

DRIVING SCREWS

When driving screws, care must be taken to use the bit that correctly fits the screw being driven. Make sure you use the largest bit size that will properly fit into the head of the screw.

1. Select the correct screwdriver bit for the screw being driven.
2. Fasten the screwdriver bit into the chuck, making sure the flat sides of the bit are gripped by the chuck jaws.
3. Set the torque clutch to the appropriate setting, based on the list on Page 13.
NOTE: If the workpiece material is particularly soft or porous, set the torque clutch to a lower setting to avoid overdriving the screw.
4. If the screw is driven too far into the workpiece before the clutch releases, set the clutch to a lower setting, and do not pull the trigger switch fully back. If the screw is not driven far enough into the workpiece, set the clutch to a higher setting.
NOTE: Do not continue to drive the screw once the clutch has released. This causes unnecessary wear of the clutch.

REMOVING THE CHUCK

1. Remove the battery pack from the drill.
2. Insert a $\frac{5}{16}$ " / 8 mm or larger hex key (1) into the chuck (2) and tighten the chuck jaws securely (Fig. 13). Make sure each of the chuck jaws (3) is seated on the flat surfaces of the hex key.
3. Tap the hex key sharply with a mallet (4) in a CLOCKWISE direction. This action will loosen the screw in the chuck for easy removal.
4. Open chuck jaws and remove the hex key.
5. Open the chuck jaws as far as possible.
6. Remove the chuck screw using a #2 ⊕ screwdriver (Fig. 14).
NOTE: Turn the screw CLOCKWISE to remove it. This screw has a left-handed thread.
7. Insert the hex key into the chuck and tighten jaws of chuck securely (Fig. 15). Tap the hex key sharply with a mallet in a COUNTERCLOCKWISE direction. This will loosen the chuck on the spindle. The chuck can now be unscrewed and removed from the spindle by hand.

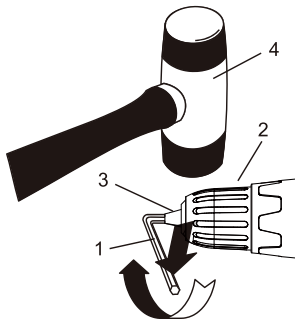

Fig. 13



Fig. 14

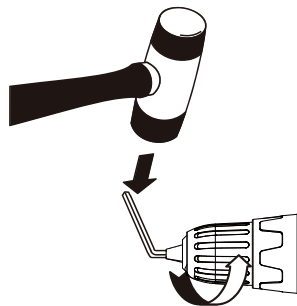

Fig. 15

ASSEMBLY AND OPERATING (continued)

RETIGHTENING A LOOSE CHUCK

1. Remove the battery pack from the drill.
2. Insert a $\frac{5}{16}$ " (8 mm) or larger hex key (1) into the chuck (2) and tighten the chuck jaws securely (Fig. 16). Make sure each of the chuck jaws (3) is seated on the flat surfaces of the hex key.
3. Tap the hex key sharply with a mallet (4) in a CLOCKWISE direction. This action will loosen the screw in the chuck for easy removal.
4. Open the chuck jaws and remove the hex key.
5. Tighten the chuck screw using a #2 ⊕ screwdriver (Fig 14).

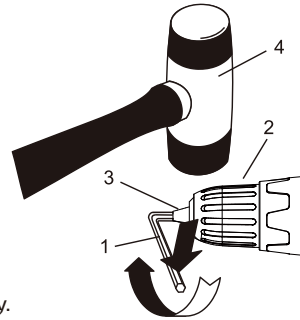

Fig. 16

NOTE: Turn the screw COUNTERCLOCKWISE to tighten it. This screw has a left-handed thread.

MAINTENANCE

GENERAL

WARNING: When servicing, use only identical replacement parts. The use of any other part may create a hazard or cause product damage.

DO NOT use solvents when cleaning plastic parts. Plastics are susceptible to damage from various types of commercial solvents and may be damaged by their use. Use a clean cloth to remove dirt, dust, oil, grease etc.

WARNING: DO NOT allow brake fluids, gasoline, petroleum-based products, penetrating oils, etc. to come into contact with plastic parts. They contain chemicals that can damage, weaken or destroy plastic.

DO NOT abuse power tools. Abusive practices can damage the tool and the workpiece.

WARNING: DO NOT attempt to modify tools or create accessories. Any such alteration or modification is misuse and could result in a hazardous condition leading to possible serious injury. It will also void the warranty.

LUBRICATION

All of the bearings in this tool are lubricated with a sufficient amount of high-grade lubricant for the life of the unit under normal conditions. Therefore, no further lubrication is required.

LITHIUM-ION BATTERY PERFORMANCE

Lithium-ion rechargeable batteries generally provide superior performance to nickel-cadmium batteries when used in power tools.

- Faster charges
- Longer battery life
- More power
- Lighter weight

Lithium-ion batteries perform best and deliver peak output power at room temperature (20° C or 68° F). When operated in lower temperatures, the battery output will be reduced and it will NOT function below -20° C (-4° F). The output power will increase as the heat generated by the battery during use increases the internal temperature of the battery. The result is increased power as the tool is used.

LITHIUM-ION BATTERY MAINTENANCE

Lithium-ion batteries share many characteristics with nickel-cadmium batteries.

The major characteristic that is NOT shared with nickel-cadmium batteries is that Lithium-ion batteries do not have a “memory” and do not require to be completely discharged periodically. It is recommended that you charge your Lithium-ion batteries after each use so they will be fully charged when needed.

NOTE: A fully charged battery will lose about 2% of its charge per month during storage.

BATTERY PACK REMOVAL AND PREPARATION FOR RECYCLING

To preserve our natural resources, please recycle or dispose of batteries properly. The batteries supplied with this tool may contain chemicals and metals that are harmful to the environment. Never dispose of rechargeable batteries in your normal household garbage or in landfill sites because they will add to the pollution of the environment. Consult your local waste authority for information regarding available recycling and disposal options.

WARNING: If the battery pack has been removed from the tool, cover the terminals of the battery pack with electrical tape or heavy-duty adhesive tape. Never touch both terminals with metal objects or body parts, because a short circuit may result. Keep away from children. Do not attempt to destroy or disassemble battery pack or remove any of its components. Rechargeable batteries must be recycled or disposed of properly. Failure to comply with these warnings could result in fire and serious injury.

WARNING: When servicing, use only original equipment replacement parts. The use of any other parts may create a safety hazard or cause damage to the tool. Any attempt to repair or replace electrical parts on this tool may create a safety hazard unless repairs are performed by a qualified technician. For more information, call the Toll-free Helpline, at 1-866-349-8665. Always order by PART NUMBER, not by key number.

PARTS

EXPLODED DIAGRAM

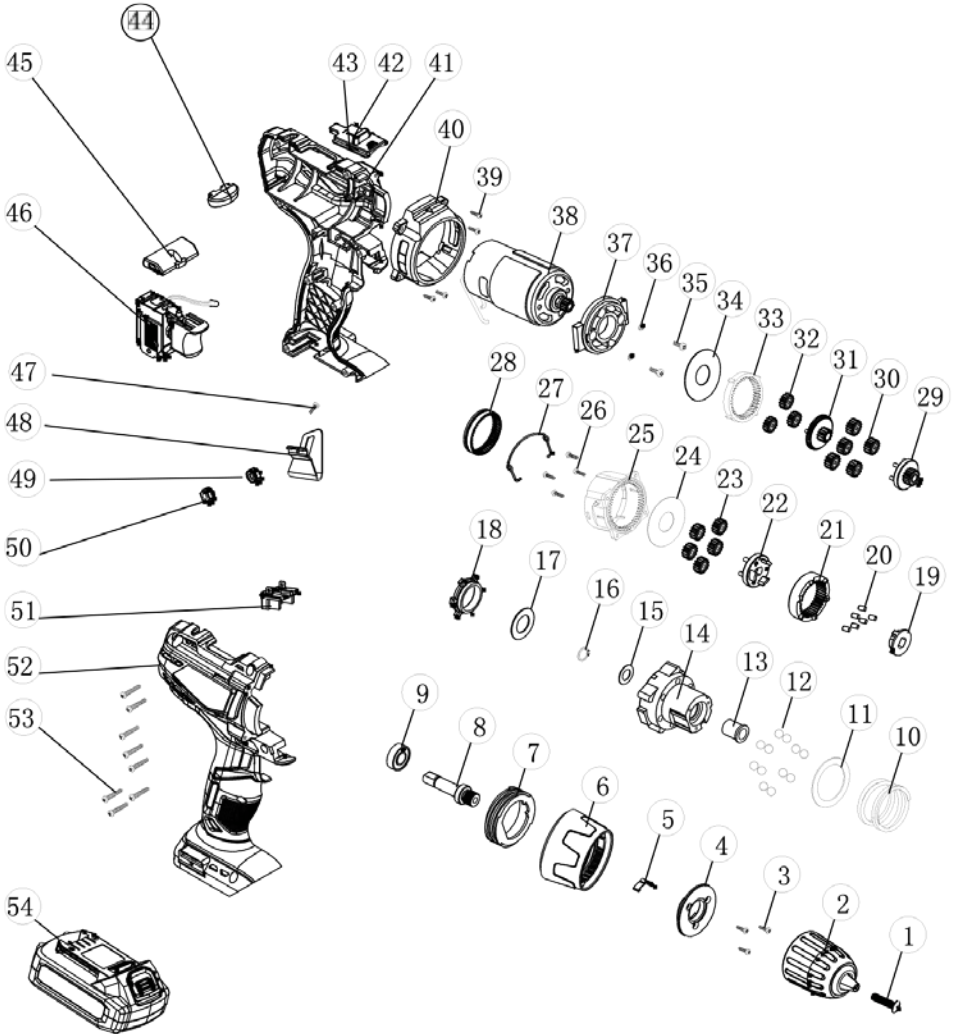

Key #	Part #	Part Name	Quantity
1	4020030007	Chuck screw	1
2	1140050009	Chuck	1
3	4030010036	Tapping screw	3
4	2020210007	Compressing plate	1
5	2050070003	Positioning spring	1
6	3120080141	Torque setting ring	1
7	3150190130	Inner threaded ring	1
8	2040050113	Shaft	1
9	4010010092	Axletree	1
10	2050080148	Spring	1
11	2030020213	Washer	1
12	4080060001	Ball group	12
13	2010080094	Shaft coat	1
14	3150070068	Gear group	1
15	2030020101	Washer	1
16	4100020001	Snap ring	1
17	2030020214	Washer	1
18	2010240034	Shaft lock ring	1
19	2010230012	Driving block	1
20	4110020003	Needle roller	6
21	2010090059	Gearing ring	1
22	1170070065	Planetary carrier	1
23	2010010087	Planetary gear	5
24	2030020007	Washer	1
25	3150080020	H/L speed switch box	1
26	4030010031	Tapping screw	4
27	2050080149	2-Speed lever	1
28	2010090060	Moveable ring gear	1
29	1170070066	Planetary carrier	1
30	2010010088	Planetary gear	5
31	1170070067	Planetary carrier	1
32	2010010089	Planetary gear	3
33	2010090061	Fixed ring gear	1
34	2030020007	Washer	1
35	4020010001	Screw	2
36	4040030001	Spring Washer	2
37	3150090038	Motor flange	1
38	1030030034	Motor assembly	1
39	4030010248	Tapping screw	4
40	3110010253	Decoration plate	1
41	3010010200	Left housing	1
42	3120120147	Speed selector button	1
43	2050080208	Lever	1
44	3160060085	Lamp chimney	1
45	3120030126	FWD/REV lever	1
46	1062010030	Switch assembly	1
47	4020010168	Tapping screw	1
48	2030100070	Belt buckle	1
49	4040080003	Lock washer	2
50	4060010039	Hexagon nut	2
51	3150170016	Contact plate	1
52	3010010200	Right housing	1
53	4030010248	Tapping screw	8
54	1290090047	Battery pack	1

WARRANTY

RADLEY CORDLESS DRILL KIT WARRANTY

If this Radley Tool fails due to a defect in material or workmanship within three years from the date of purchase, return it to any Home Hardware store with the original bill of sale for exchange. Two years for battery and charger. This warranty does not include expendable parts including but not limited to blades, brushes, belts and light bulbs. This warranty covers defects in material or workmanship only. It does not cover normal wear and tear, failure due to abuse/misuse, or defects caused by careless or accidental mishandling. If this Radley product is used for commercial or rental purposes, this warranty does not apply.

20V Max Cordless Drill

3 Year limited warranty (for tool)
and 2 year limited warranty
(for the battery and charger).



2 Variable
Speeds



60 Minute
fast charging

2 Batteries

Radley®

EXCLUSIVE TO HOME HARDWARE

For information on the entire line-up of Radley power
tools visit homehardware.ca or your local Home Hardware retail store.

MADE IN CHINA / FABRIQUÉ EN CHINE
HOME HARDWARE STORES LIMITED
ST. JACOBS, ONTARIO N0B 2N0
ORDER ONLINE / COMMANDE EN LIGNE
homehardware.ca

© 04 / 2020 Home Hardware Stores Limited



1239-222