

# Radley®

## 20V Max\* Cordless Grass Trimmer & Blower/ Sweeper Kit

User Manual:  
Part A - Cordless  
Blower/sweeper, Battery  
and Charger



*3 Year limited warranty (for tool)  
and 2 year limited warranty  
(for the battery and charger).*



Intertek  
3042597  
JD580320

**READ ALL INSTRUCTIONS BEFORE FIRST USE.  
KEEP THIS MANUAL FOR FUTURE REFERENCE.  
KEEP AWAY FROM CHILDREN.**

\*Maximum initial battery voltage (measured without a load)  
is 20 volts. Normal voltage is 18 volts.



**WEAR CSA APPROVED  
EYE PROTECTION**



**WEAR EAR  
PROTECTION**



**WEAR A  
FACE MASK**

## PRODUCT SPECIFICATIONS

<b>BLOWER/SWEEPER</b>	
Air speed	130 MPH
Blower tube	18.5" (470 mm)
Noise level	92 dBA (maximum)
Weight	3 lbs 9 oz

<b>BATTERY AND CHARGER</b>	
Battery voltage:	20V 2.0 Ah Li-ion (Maximum charged battery voltage, measured without load, is 20V with a nominal value of 18V)
Charger	Up to 70 minutes, Class 2
Replacement battery	5350-547
Replacement charger	DL125418

### Need Assistance?

Call us on our toll free customer support line:

1-866-349-8665 (Monday through Friday 9am – 5pm Eastern Time)

- Technical questions
- Replacement parts
- Parts missing from package

## TABLE OF CONTENTS

Product specifications .....	1
Table of contents .....	2
General safety warnings .....	3-5
Important safety instructions .....	3
Safety symbols .....	3-5
Electric gardening tool safety .....	5-7
General safety warnings .....	5
Work area safety .....	5
Electrical safety .....	5-6
Personal safety .....	6-7
Service .....	7
Specific safety rules .....	7-12
Battery & charger safety .....	12-13
Battery pack recycling .....	13
Symbols .....	14
Know your blower .....	15
Know your battery .....	16
Assembly and operating .....	17-20
Charging the battery pack .....	17
Installing the battery pack in the blower .....	18
Assemble & install nozzle .....	18
ON/OFF switch .....	18
Operating the blower .....	19
Cleaning the air intake .....	19-20
Maintenance .....	21
Battery pack removal and preparation for recycling .....	21
Exploded view .....	22
Parts list .....	23
Warranty .....	24

## GENERAL SAFETY WARNINGS

### IMPORTANT SAFETY INSTRUCTIONS

#### READ AND UNDERSTAND ALL SAFETY AND OPERATIONAL INSTRUCTIONS.



Failure to follow the safety rules listed below and other basic safety precautions may result in serious personal injury. KEEP THIS MANUAL, SALES RECEIPTS AND APPLICABLE WARRANTY FORMS FOR FUTURE REFERENCE.

#### This instruction manual includes the following:





- General Safety Rules
- Specific Safety Rules and Symbols
- Functional Description
- Assembly
- Operation
- Maintenance
- Accessories

### Safety Symbols



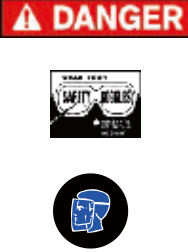

The purpose of safety symbols is to alert you of the potential safety RISKS. Recognize and understand them. Follow the instructions provided.

SYMBOL	MEANING
	Failure to obey a DANGER safety alert <b>WILL</b> result in serious personal injury or death to you or to others. Always obey all messages following this symbol to reduce the risk of serious personal injury or death.
	Failure to obey a WARNING safety alert <b>MAY</b> result in serious personal injury or death to you or to others. Always obey all messages following this symbol to reduce the risk of potential serious personal injury or death.
	Failure to obey a CAUTION safety alert <b>MAY</b> result in personal injury or property damage to you or to others. Always obey all messages following this symbol to reduce the risk of personal injury or property damage.

**READ ALL INSTRUCTIONS BEFORE USING THIS BLOWER**

SYMBOL	MEANING
	<p>Failure to obey a NOTICE or a CAUTION (without a safety alert) <b>MAY</b> result in property damage to you or to others. Always obey all messages following this symbol to reduce the risk of property damage.</p>
	<p><b>ALWAYS WEAR EYE PROTECTION THAT CONFORMS WITH CSA Z94.3 or ANSI SAFETY STANDARD Z87.1</b></p> <p>FLYING DEBRIS can cause permanent eye damage. Prescription eyeglasses ARE NOT a replacement for proper eye protection. The usage of a safety standard compliant face shield placed over proper safety glasses or goggles can reduce the risk of facial injury.</p> <p><b>Noncompliant eyewear can cause serious injury if broken during the operation of a power tool.</b></p>
	<p><b>Use hearing protection, particularly during extended periods of operation of the tool, or if the operation is noisy.</b></p>
	<p><b>WEAR A DUST MASK THAT IS DESIGNED TO BE USED WHEN OPERATING A POWER TOOL IN A DUSTY ENVIRONMENT.</b></p>
	<p><b>Always wear nonslip gloves that fit properly to protect your hands and to help you grip the tool.</b></p> <p><b>Always wear sturdy clothing with long sleeves and long pants. Never operate the tool while wearing shorts, short sleeve shirt or while shirtless.</b></p> <p><b>Always wear nonslip safety boots to prevent foot injuries and slipping that could cause loss of control of the tool.</b></p>

**READ ALL INSTRUCTIONS BEFORE USING THIS BLOWER**

SYMBOL	MEANING
 	<p><b>To avoid electrical hazards, fire hazards or damage to the tool, use proper circuit protection.</b></p> <p>This tool is wired at the factory for 120 V AC operations. It must be connected to a 120 V AC, 15 A circuit that is protected by a time-delayed fuse or circuit breaker. To avoid shock or fire, replace power cord immediately if it is worn, cut or damaged in any way.</p>
 	<p><b>WARNING:</b> Ventilation openings in batteries and chargers must always be open to allow cooling air to circulate freely. Air vents that are blocked, restricted or covered may result in the battery or charger overheating. Overheating may lead to damage to the tool or cause a fire, resulting in possible serious injury.</p>

## ELECTRIC GARDENING TOOL SAFETY

### GENERAL SAFETY WARNINGS

 **WARNING:** Read all safety warnings and all instructions. Failure to follow the warnings and instructions may result in electric shock, fire and/or serious injury.

Save all warnings and instructions for future reference.

### General Electric Gardening Tool Safety Warnings – Work Area Safety

**Do not operate power tools in explosive atmospheres, such as in the presence of flammable liquids, gases or dust.** Power tools create sparks which may ignite the liquids, fumes or dust.

**Keep children and bystanders away while operating a power tool.** Distractions can cause you to lose control.

### General Electric Gardening Tool Safety Warnings – Electrical Safety

**Battery charger plugs must match the outlet. Never modify the plug in any way. Do not use any adapter plugs with earthed (grounded) chargers.** Unmodified plugs and matching outlets will reduce risk of electric shock.

**Avoid body contact with earthed or grounded surfaces such as water pipes.** There is an increased risk of electrical shock if your body is earthed or grounded.

**SAVE THESE INSTRUCTIONS FOR REFERENCE**

**Do not expose power tools, battery chargers or batteries to rain or wet conditions.** Water entering the tool, chargers or batteries will increase the risk of electric shock.

**Do not abuse the cord. Never use the power cord for carrying, pulling or unplugging the charger. Keep the power cord away from heat, oil, sharp edges, and moving parts.** Damaged or entangled cords increase the risk of electric shock.

**When operating the charger outdoors, use an extension cord suitable for outdoor use.** Use of a cord suitable for outdoor use reduces the risk of electric shock.

**Never operate a power tool in the rain.**

**If operating a charger in a damp location is unavoidable, use a residual current device (RCD) protected supply. An RCD is also known as a ground fault circuit interrupter (GFCI) or earth leakage circuit breaker (ELCB).** Use of an RCD reduces the risk of electric shock.

#### **General Electric Gardening Tool Safety Warnings – Personal Safety**

**Stay alert, be aware of your surroundings, watch what you are doing and use common sense when operating a power tool. Do not use a power tool while you are tired or under the influence of drugs, alcohol, or medication.** A moment of inattention while operating a power tool may result in serious personal injury.

**Use personal protective equipment. Always wear eye protection.** Protective equipment such as dust mask, nonskid safety shoes or boots, sturdy gloves, durable long pants, long sleeve shirt and hearing protection will reduce the risk of personal injuries.

**Prevent unintentional starting. Ensure the switches are in the off-position before connecting the battery to the power tool or plugging it into the power supply.**

**Never pick up or carry the power tool with your finger on the trigger switch.**

Carrying power tools with your finger on the switch or energizing power tools that have the switch on invites accidents.

**Remove any adjustment key or wrench before turning the power tool on.** A wrench or a key left attached to a rotating part of the power tool may result in personal injury.

**Do not overreach. Keep proper footing and balance at all times.** This enables better control of the power tool in unexpected situations.

**Dress properly. Do not wear loose clothing or jewellery. Keep your hair, clothing and gloves away from moving parts.** Loose clothing, jewellery or long hair can be caught in moving parts.

**SAVE THESE INSTRUCTIONS FOR REFERENCE**

**Do not force the tool. Use the correct tool for the application.** The correct power tool will do the job better and safer when used at the rate for which it was designed.

**Do not use a power tool if the switch does not turn it on or off.** Any power tool that cannot be controlled using the switch is dangerous and must be repaired.

**Remove the battery from the power tool or the plug from the power source before making any adjustments, replacing or repairing parts, cleaning the tool, leaving the tool idle or unattended, transporting or storing the tool.** Such preventive safety measures reduce the risk of starting the power tool accidentally.

**Store idle power tools out of the reach of children and do not allow persons unfamiliar with the power tool or these instructions to operate the power tool.** Power tools are dangerous in the hands of untrained users.

**Maintain power tools. Check for misalignment or binding of moving parts, breakage of parts and any other condition that may affect the power tool's operation. If damaged, have the power tool repaired before use.** Many accidents are caused by poorly maintained power tools.

**Use the power tool and accessories in accordance with these instructions, taking into account the working conditions and the work to be performed.** Use of the power tool for operations different from those intended could result in a hazardous situation.

### **General Electric Gardening Tool Safety Warnings – Service**

**Have your power tool or charger serviced by a qualified repair person using only identical replacement parts.** This will ensure that the safety of the power tool or charger is maintained.

## **SPECIFIC SAFETY RULES**

**⚠ WARNING:** Some dust created by power sanding, sawing, grinding, drilling, and other construction activities contain chemicals known to cause cancer, birth defects, or other reproductive harm. Some samples of these chemicals are:

- lead from lead-based paints
- crystalline silica from bricks and cement and other masonry products
- arsenic and chromium from chemically-treated lumber

**SAVE THESE INSTRUCTIONS FOR REFERENCE**



Your risk from these exposures varies, depending on how often you do this type of work. To reduce your exposure to these chemicals: work in a well-ventilated area, and work with approved safety equipment, such as those dust masks that are specially designed to filter out microscopic particles.



**! WARNING: Know your leaf blower. Do not plug in the charger or install the battery onto the tool until you have read and understand this Instruction Manual. Learn the tool's applications and limitations, as well as the general and specific potential hazards related to this tool.** Following these instructions will reduce the risk of electric shock, fire or serious injury.



**! WARNING: Always wear appropriate eye protection.** Any power tool can throw foreign objects into your eyes and cause permanent eye damage. ALWAYS wear appropriate safety goggles or properly fitted safety glasses that comply with the most recent version of ANSI Z87.1 safety standards. Ordinary vision or sunglasses generally do not provide adequate impact or side shield / wrap around penetration protection. Ordinary glasses ARE NOT safety glasses. To reduce the risk of injury to your face you should also wear a face shield over your safety goggles or safety glasses.



**! WARNING: Glasses, goggles or face shields not in compliance with ANSI Z87.1 or CAN/CSA – Z94.3 could cause serious injury if they break upon impact.**



**! WARNING: Prevent foot injuries!** Never operate when barefoot, or wearing open toed shoes, or sandals. Always, wear sturdy protective shoes or boots with nonslip soles when operating the leaf blower. Steel-toed safety boots are recommended.



**! WARNING: Protect your hands by wearing heavy-duty, nonslip gloves and to improve your grip and control when handling the blower.**



**! WARNING: Clothing must be durable and snug-fitting, yet allow for freedom of movement.**

**! WARNING: Avoid loose clothing such as scarves, neckties, jewellery, flared or cuffed pants, loose-fitting shirts or jackets, unconfined long hair or anything that can be pulled into the air intake of the blower. Secure hair to above shoulder level. Wear long pants of durable material to protect your legs.**

**SAVE THESE INSTRUCTIONS FOR REFERENCE**

Cover as much of your body as possible to help protect you from debris and pieces of toxic and allergenic plants being thrown by the blower.



**WARNING: Use hearing protection.** Use hearing protection such as ear plugs or ear muffers to protect your hearing, particularly if the blower is used for extensive periods or if the surrounding environment of operation exposes the operator to loud noises. When wearing hearing protection, you will have impaired ability to hear alarms, warnings and shouts from approaching people or approaching vehicles. Be extra diligent and observant of hazards and bystanders when wearing hearing protection devices. When someone approaches, turn the blower OFF immediately.

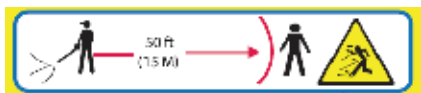

**WARNING:** The high velocity of the air flow coming through the nozzle will throw objects and debris violently. These objects and debris will ricochet in all directions. **You or bystanders can be blinded or injured.** Keep children, bystanders, pets and other animals at least 50 feet (15 meters) away from the operating blower. Turn the blower OFF immediately if approached, or if you are approaching such bystanders. Bystanders should be encouraged to wear eye protection, even if they are kept at a distance.

Thrown objects may also ricochet and strike the operator or bystander.

Utilize extra caution, when the blower is being used near, or on paved or hard surfaces, as pieces of metal, concrete, brick, stones, gravel, sand, glass, sticks and other objects can be thrown at high speed and force and such objects can be thrown, skip along or ricochet long distances off of hard surfaces.

Do not use this blower for sweeping debris that may contain hard objects, e.g. pebbles, stones, sticks, glass, metal, etc. as such hard objects can be thrown with great force and cause injury to the operator or bystanders, and / or damage property, e.g., screens, windows, building siding, glass doors, or vehicles.

Avoid operating the blower near property that can be easily damaged by thrown or ricocheting objects such as screens, windows, building siding, glass doors and vehicles.



**WARNING:** Always wear breathing protection when operating the blower. Bystanders should be encouraged to wear breathing protection devices even if they are kept at a distance as hazardous dust can travel considerable distances, especially if the dust is wind blown.

**SAVE THESE INSTRUCTIONS FOR REFERENCE**



**WARNING:** Know what you are going to blow, before you blow.



**WARNING:** Inspect the area to be cleared for hazards before each use. Remove any foreign objects such as sticks, rocks, broken glass, nails, wire, tools, toys, etc. which can be thrown by the blower.



**WARNING:** If you are suspicious or uncertain if the material that you are considering blowing would cause hazardous dusts, first, identify and investigate the nature of the materials.

If the materials have the potential to be hazardous, do not use the blower, instead, utilize other safe clean up procedures and disposal procedures. If you are suspicious that you have been blowing or come into contact with asbestos, or crystalline silica materials or hazardous chemical or biological materials, contact your doctor, your employer if your use of the blower is job related, and the local EPA or OSHA representative immediately. Clean up and dispose of hazardous chemicals and substances prior to using the blower, using appropriate clean up procedures, personal protective equipment and disposal methods.



**WARNING:** Dust created by use of this product may contain chemicals known to the State of California and medical experts to cause cancer, respiratory injuries, birth defects or other reproductive harm. Some examples of these chemicals are:

- Compounds in fertilizers
- Compounds in insecticides, herbicides and pesticides
- Arsenic and chromium from chemically treated lumber.
- Commercial and household chemicals.

To reduce your exposure to these chemicals, wear approved safety equipment such as dust and / or vapor masks that are specifically designed to filter out microscopic particles or gaseous components. Additionally, dust created by this product may contain allergens, bacteria and viruses, PM 10 and / or PM 2.5 particulates, exposure to such hazardous airborne matter can be reduced by wearing approved safety equipment such as dust masks that are specifically designed to filter out the microscopic particles.



**WARNING:** Breathing asbestos or dust with silica in its composition may contain hazardous crystalline silica. Silica is a fundamental component of sand, quartz, brick, clays, granite and many other materials and rocks, including masonry, concrete and cement products. Such crystalline silica dust is dangerous and must be avoided, as it can cause severe or fatal respiratory illness or cancer.

**SAVE THESE INSTRUCTIONS FOR REFERENCE**

**⚠ WARNING:** Avoid blowing near open windows or doors, or anywhere near bystanders or animals as doing such may cause exposure to the potentially hazardous dust, particularly downwind of your blowing operation due to the respiratory hazard reasons previously stated.

Do not work against the wind as the dust will blow back towards the operator increasing the exposure to the dust.

Keep the blower below waist level and point the blower nozzle below waist level.



**⚠ WARNING:** Check the blower fan screen before each use to make sure the air intake screen and the fan are in good condition. If any damage is identified, replace the part immediately before using the blower. A damaged fan may shatter and a damaged air intake screen will allow your fingers to be injured by the fan.

**⚠ WARNING:** Never operate the blower without the nozzle and the intake fan screen in place. Serious injury or damage to the blower may result.

**⚠ WARNING:** Never insert a foreign object such as a screwdriver, stick, etc. into the nozzle, air exhaust tube or the intake fan screen. Any foreign article that becomes lodged in the air system may be ejected at great speed causing serious injury when the blower is turned ON. It may also severely damage the blower fan.

**⚠ WARNING:** Always remove the battery when making adjustments, changing the nozzle, removing debris from the blower screen, leaving the tool idle or unattended, cleaning, servicing, storing or transporting the tool. Such preventive measures reduce the risk of starting the tool accidentally and causing serious injury.

**⚠ WARNING:** Never modify the blower in any way. It is designed to be used only with the nozzle and power cell that are supplied with the tool. The use of any other accessory or modifying the tool may create a safety hazard. This action will also void the warranty.

Never use the blower without the nozzle properly installed. This will allow you to direct the air flow where you want it and make the tool more efficient.

Always keep the handles clean. Handles that are covered with grease, chemicals or debris will make holding onto the blower difficult. Use a clean cloth dampened with soapy water to clean these surfaces.

Never use a pressure washer, garden hose or any other liquid or chemical solvents to clean the blower.

**SAVE THESE INSTRUCTIONS FOR REFERENCE**

**⚠ WARNING:** When blowing very dusty materials in extremely dry conditions for long periods of time, static electricity may build up and discharge without warning. To avoid this situation in dry dusty conditions, only operate the blower for short periods of time and turning the blower OFF at regular intervals.

Maintain firm footing and balance at all times. Do not overreach or use the blower from unstable surfaces such as ladders, trees, steep slopes, slippery surfaces, rooftops, etc.

Always grasp the blower using the handles on the machine.

Use only in daylight or in good quality artificial light.

Never use the blower for anything other than its intended purpose. Use for anything other than blowing leaves, grass, weeds or lawn debris can be dangerous. It may also damage the blower.

Never walk backwards while the blower is turned ON as you might trip and may not hear approaching persons or vehicles.

## BATTERY & CHARGER SAFETY

**⚠ WARNING:** Only use the diagnostic charger supplied with this kit to charge the 20V Li-ion battery. Charging any other batteries may damage the charger and possibly cause serious injury.

Do not store or carry the battery in a manner in which metal objects could contact the exposed metal end. Do not place the battery in aprons, pockets, drawers, etc. with loose nails, screws, keys etc. The battery could short circuit causing a fire, personal injury or damage to the battery.

Never attempt to open the battery for any reason. If the housing of the battery breaks or cracks, immediately discontinue use and do not recharge.

Do not charge the battery if it is wet or shows any evidence of corrosion.

A small leakage from the battery may occur under extreme usage, charging or temperature conditions. This does not indicate a failure. However, if the outer seal is broken and this leakage gets on your skin, follow these steps:

1. Wash immediately with soap and water.
2. Neutralize with a mild acid such as lemon juice or vinegar.
3. If liquid gets into your eyes, flush immediately with clean water for a minimum of 10 minutes and seek medical attention.

**SAVE THESE INSTRUCTIONS FOR REFERENCE**

NOTE: The battery liquid is slightly acidic.

Do not incinerate the battery. It can explode in a fire.

Do not use an extension cord. Plug the charger cord directly into an electrical outlet.

Use the charger only in a standard 120V, 60 Hz electrical outlet.

Do not use the charger in wet or damp conditions. It is intended for indoor use only. Do not use the charger near sinks or tubs. Do not immerse the charger in water.

Do not allow the cord to hang over the edge of a table or counter or touch hot surfaces. The charger should be placed away from sinks and hot surfaces.

Do not use the charger to charge any batteries other than the blower batteries. Other batteries may explode.

Do not operate charger if the cord or plug is damaged. Replace the damaged cord and plug immediately.

Do not operate the charger if it has received a sharp blow, been dropped or otherwise damaged in any way. Have a qualified technician examine the charger and repair it if necessary. Do not disassemble the charger.

Do NOT charge the batteries when the work area or the battery temperature is at or below 41°F / 5°C or above 105°F / 40.5°C.

Unplug the charger when not in use and before cleaning or maintenance.

## **BATTERY PACK RECYCLING**













To preserve our natural resources, please recycle or dispose of batteries properly.

The batteries charged by this charger may contain chemicals and metals that are harmful to the environment. Never dispose of rechargeable batteries in your normal household garbage or in landfill sites as they will add to the pollution of the environment.

**SAVE THESE INSTRUCTIONS FOR REFERENCE**

## SYMBOLS

**⚠ WARNING:** Some of the following symbols may appear on the blower. Study these symbols and learn their meaning. Proper interpretation of these symbols will allow for more efficient and safer operation of this tool.

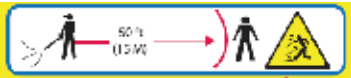
	Volts
	Amperes
	Hertz
	Watts
	Hours
	Direct current
	Alternating or direct current
	Warning symbol
	Shock hazard
	Striking hazard
	Blower hazard
 <p>Keep bystanders back at least 50' (15m)</p>	

	Read the manual
	Wear safety glasses
	Wear safety goggles
	Wear full-face shield
	Wear hearing protection
	Wear breathing protection
	Wear safety gloves
	Wear safety boots
	Wear snug fitting clothing
	Risk of fire



This symbol designates that this tool is listed with U.S. requirements by ETL Testing Laboratories, Inc. Conforms to UL Std. 1017:2010. Certified to CAN/CSA STD C22.2 #243:2010.

## KNOW YOUR BLOWER

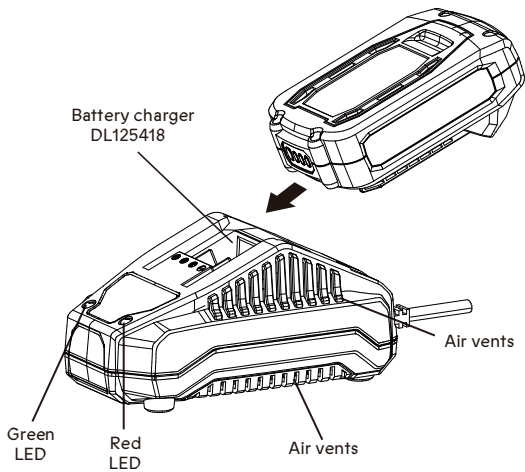
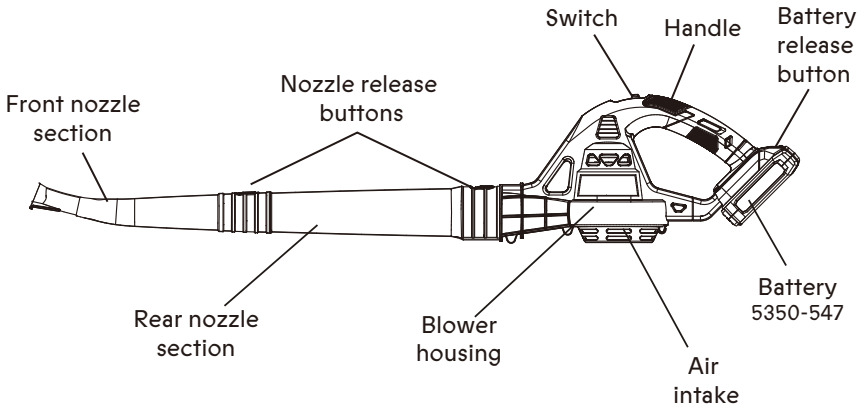



## KNOW YOUR BATTERY

### CHECKING THE BATTERY CHARGE STATUS

The level of charge remaining in the battery can be checked by using the battery LED power indicator that is contained on the end of the battery.

**NOTE:** The battery charge remaining may be checked while the battery is installed in the tool with the ON/OFF switch turned OFF. It may also be checked while the battery is removed from the tool. DO NOT check the battery charge remaining while the battery is in the charger. You will get a false reading and you may also damage the battery status system.

1. Press and hold the battery status button located on the end of the battery
2. One or more of the Three LED lights in the LED window will come ON to indicate the amount of charge that is remaining in the battery as follows:

1 light (Red light ON)	2 lights (Red and orange light ON)	3 lights (Red/Orange/Green ON)
1/3 or less	1/3 - 2/3	2/3-Fully charged



3. Release the battery status button to turn the LED's OFF.

## ASSEMBLY AND OPERATING

### CHARGING THE BATTERY PACK

1. Place the battery charger (1) in a dry location near a 110-120v 60Hz electrical outlet (Fig.1)
2. Plug the battery charger into the outlet and make sure the green LED indicator light (5) comes ON. If it does not, refer to the chart (Fig.2.) to identify the problem
3. Turn the battery (2) upside down and slide it onto the charger.
 

NOTE: Make sure the grooves (3) in the sides of the battery slide over the matching tabs on the charger (4) until the battery latch "clicks" into place.

### NOTES:

1. When the charger is plugged into the wall receptacle and NO battery is on the charger, the green indicator light (5) will turn ON indicating the charger is "live".
2. When a discharged battery is installed on the charger, the green indicator light will turn OFF and the red indicator light (6) will turn ON. The red indicator light indicates the battery is being charged.
3. If the red indicator light does not come ON, check to make sure charger pack is slid fully onto the battery and the electrical outlet is working properly.
4. See Fig. 2 below for other indicator light functions.
5. A discharged battery pack should be fully charged in approximately 70 minutes.
6. It is normal for the battery charger to hum and be warm to the touch during operation.
7. If the battery pack does not charge properly, check to make sure the electrical outlet is "live".
8. Do NOT charge batteries when the work area or the battery temperature is at or below 41°F / 5°C or above 105°F / 40.5°C.

Fig. 2

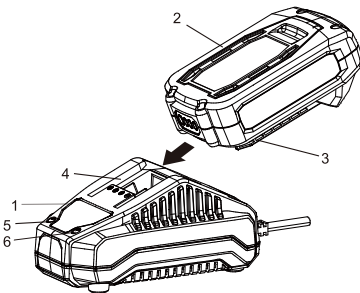

Fig. 1

Green Light	Red Light	Battery Inserted Into Charger	Charging Status
ON	OFF	NO	Charging connected to power supply.
OFF	ON	YES	Battery being charged.
ON	OFF	YES	Battery fully charged.
ON	OFF	YES	Battery is charged but not operational on tool. This may indicate defective / bad contact on battery or charging conditions are either too hot or too cold.

## INSTALLING THE BATTERY PACK IN THE BLOWER

1. Remove the discharged battery pack (1) from the tool by pressing the battery release button (2) on the rear of the battery downward (Fig. 3) and pulling the battery pack out of the tool handle (3) (Fig. 4).
2. Insert the fully charged battery pack into the matching slots in the rear of the tool handle where the discharged battery pack has been removed.

**NOTE:** The battery release button will “click” into place when the battery pack is fully installed.

**⚠ WARNING: Do not immerse battery pack in water. Sudden cooling could cause a hot battery to explode or leak.**

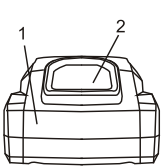

Fig. 3

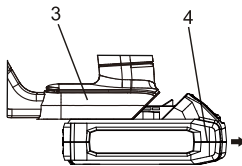

Fig. 4

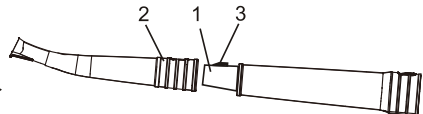

Fig. 5

## ASSEMBLE & INSTALL NOZZLE

Assemble rear and front nozzle sections as follows:

1. Insert the small end of the rear nozzle section (1) into the large end of the front nozzle section (2) (Fig. 5).
2. Push the two nozzle sections until the nozzle release button (3) “clicks” into place to lock the nozzle sections together.

Install the nozzle assembly to the blower as follows:

3. Slide the large end of the rear nozzle section (4) over the blower intake (5) (Fig. 6).
4. Push the rear nozzle section firmly onto the blower intake until the nozzle release button (6) “clicks” into place locking the nozzle assembly onto the blower intake.

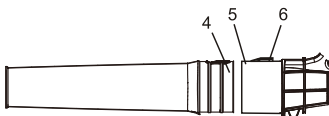

Fig. 6

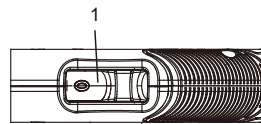

Fig. 7

## ON/OFF SWITCH

To turn the blower ON, slide the ON/OFF switch (1) forward (Fig. 7). To turn the blower OFF, slide the ON/OFF switch toward the rear of the tool.

## **⚠ WARNING**

For safety reasons, the operator must read the sections of this Owner's Manual entitled **GENERAL SAFETY WARNINGS, ELECTRIC GARDENING TOOL SAFETY, SPECIFIC SAFETY RULES, BATTERY & CHARGER SAFETY, BATTERY PACK RECYCLING** and **SYMBOLS** before using this blower.

Verify the following every time the blower is used:

1. Safety glasses or goggles, hearing protection device, hearing protection and all required safety clothing are being worn.
2. The area of operation is cleared of all dangerous debris such as broken glass and free of materials that could derive hazardous dust.
3. Bystanders are at least 50' (15 m) away from the operation area.

Failure to observe these safety rules will significantly increase the risk of injury.

## **OPERATING THE BLOWER**

The blower is well balanced and is designed to be used with one hand (Fig. 8).

**⚠ WARNING:** Always wear appropriate personal protective equipment.

Operate the blower below your waist height at all times. The most effective position for blowing is to hold the blower at an angle of less than 45° to the ground and with the nozzle close to the ground. Using a side to side sweeping motion will make clearing large areas easier.

## **CLEANING THE AIR INTAKE**

It is important to provide unrestricted air flow into the blower fan. Check the air intake grille often to make sure it is clean and not restricting the incoming air.

**⚠ WARNING:** Remove the battery from the blower before cleaning debris from the blower intake grille.

1. Turn the blower onto its right side (Fig. 9).
2. Carefully brush any debris off the air intake grille (1).

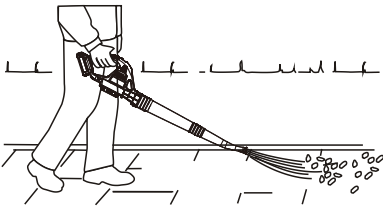

Fig. 8

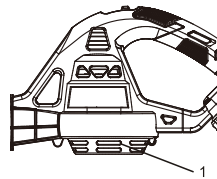

Fig. 9

Fig. 2

**NOTES:**

- a) Use a soft dry brush or a dry rag to remove the debris.
  - b) NEVER use water or any other liquid as you will damage the motor and/or the screen.
  - c) NEVER insert a screwdriver or other small tool into the intake grille. You may break the grille or the blower fan.
3. When all the debris is removed from the grille, turn the blower onto its left side and shake out any loose debris that may have fallen through the grille into the blower fan.

## MAINTENANCE

### GENERAL

**⚠ WARNING: When servicing, use only identical replacement parts. The use of any other part may create a hazard or cause product damage.**

DO NOT use solvents when cleaning plastic parts. Plastics are susceptible to damage from various types of commercial solvents and may be damaged by their use. Use a clean cloth to remove dirt, dust, oil, grease etc.

**⚠ WARNING: Do not allow brake fluids, gasoline, petroleum-based products, penetrating oils, etc. to come into contact with plastic parts. They contain chemicals that can damage, weaken or destroy plastic.**

DO NOT abuse power tools. Abusive practices can damage the tool and the workpiece.

**⚠ WARNING: DO NOT attempt to modify tools or create accessories. Any such alteration or modification is misuse and could result in a hazardous condition leading to possible serious injury. It will also void the warranty.**

### LUBRICATION

All of the bearings in this tool are lubricated with a sufficient amount of high-grade lubricant for the life of the unit under normal conditions. Therefore, no further lubrication is required.

### BATTERY PACK REMOVAL AND PREPARATION FOR RECYCLING

To preserve our natural resources, please recycle or dispose of batteries properly.

The batteries accompanying this tool may contain chemicals and metals that are harmful to the environment. Never dispose of rechargeable batteries in your normal household garbage or in landfill sites, because they will add to the pollution of the environment.

Consult your local waste authority for information regarding available recycling and disposal options.

**⚠ WARNING: Upon removal of the battery pack, cover the terminals of the battery pack with electrical tape or heavy-duty adhesive tape. Never touch both terminals with metal objects or body parts, because a short circuit may result. Keep away from children. Do not attempt to destroy or disassemble battery pack or remove any of its components. Rechargeable batteries must be recycled or disposed of properly. Failure to comply with these warnings could result in fire and serious injury.**

**EXPLODED VIEW**

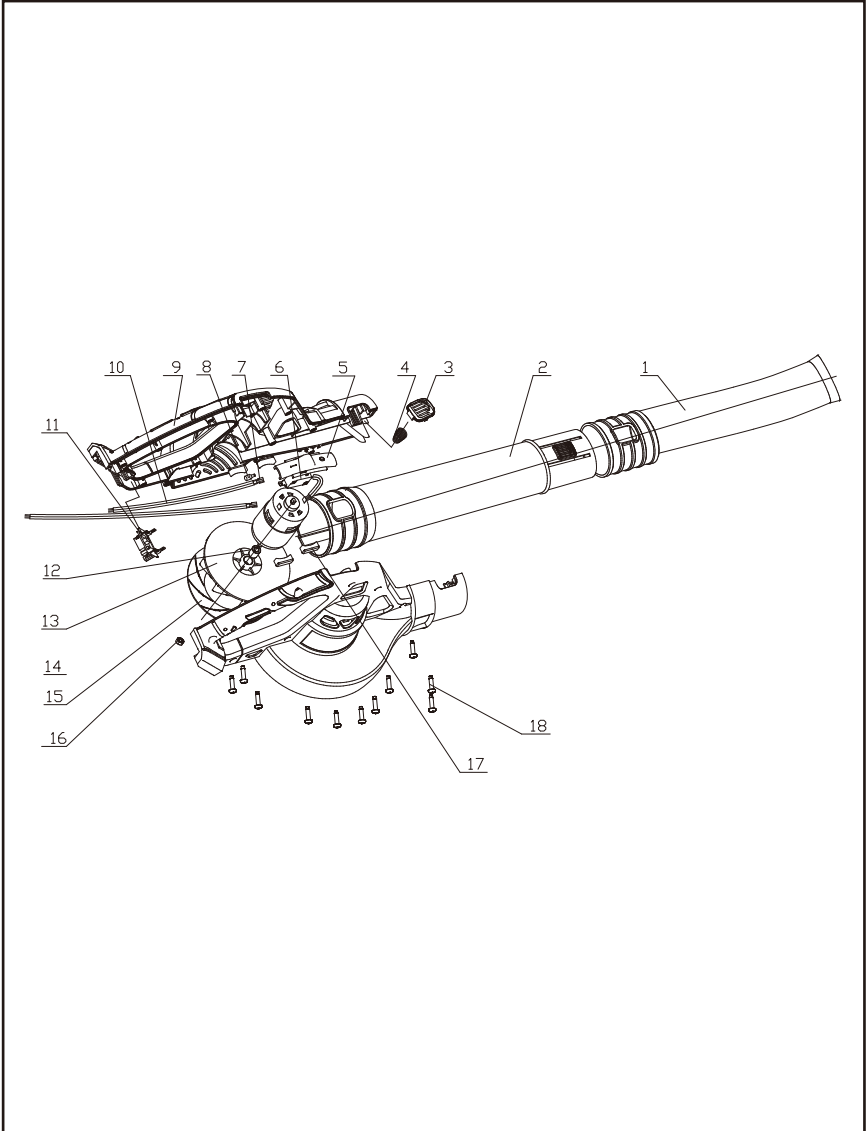

## PARTS LIST

**⚠ WARNING:** When servicing, use only original equipment replacement parts. The use of any other parts may create a safety hazard or cause damage to the blower.

Any attempt to repair or replace electrical parts on this blower may create a safety hazard unless repairs are performed by a qualified technician. For more information, call the Toll-free Helpline, at 1-866-349-8665 – Friday from 9am to 5pm Eastern Standard Time.

Always order by PART NUMBER, not by key number.

Key #	Part #	Part Name	Quantity
1	3120160003	Forward Air Pipe	1
2	3120160004	Back Air Pipe	1
3	3120020156	Air Pipe Button	1
4	2050040080	Spring	1
5	3120010127	Tower Switch	1
6	1062010027	Switch	1
7	7010070003	Copper Plugs	2
8	7010070016	Huge Protector	2
9	3010250001	Housing	1
10	1300220001	Lead Wire	1
11	3150170016	Plate Electrode Jd6292	1
12	2010080146	Locating Bush	1
13	3160090113	Fan Coverplate	1
14	1030070031	775 High Performance Motor	1
15	3150010120	Fan	1
16	4060010036	Hex Hut	1
17	3140060059	775 Motor Block	4
18	4020010004	Screw	12



## **WARRANTY**

### **RADLEY CORDLESS BLOWER/SWEEPER WARRANTY**

If this Radley Tool fails due to a defect in material or workmanship within three years from the date of purchase, return it to any Home Hardware store with the original bill of sale for exchange. Two years for battery and charger. This warranty does not include expendable parts including but not limited to blades, brushes, belts and light bulbs. This warranty covers defects in material or workmanship only. It does not cover normal wear and tear, failure due to abuse/misuse, or defects caused by careless or accidental mishandling. If this Radley product is used for commercial or rental purposes, this warranty does not apply.

20V Max\*  
**Cordless Grass  
Trimmer &  
Blower/  
Sweeper Kit**

*Includes 1 battery & 1 charger  
3 Year limited warranty (for tool)  
and 2 year limited warranty  
(for the battery and charger).*



**Radley®**

**EXCLUSIVE TO HOME HARDWARE**

**For information on the entire line-up of Radley power  
tools visit [homehardware.ca](http://homehardware.ca) or your local Home Hardware retail store.**

MADE IN CHINA / FABRIQUÉ EN CHINE  
HOME HARDWARE STORES LIMITED  
ST. JACOBS, ONTARIO N0B 2N0  
ORDER ONLINE / COMMANDE EN LIGNE  
[homehardware.ca](http://homehardware.ca)

© 10 / 2020 Home Hardware Stores Limited



**5073-356**