

BENCHMARKTM MC

20V MAX BRUSHLESS HEDGE TRIMMER

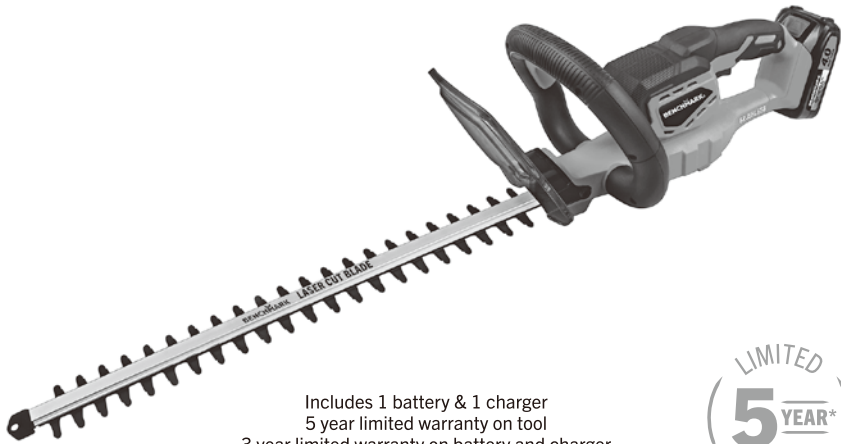

Includes 1 battery & 1 charger
5 year limited warranty on tool
3 year limited warranty on battery and charger

LIMITED
5 YEAR*
WARRANTY



E114847
JD5512

**READ ALL INSTRUCTIONS BEFORE FIRST USE.
KEEP THIS MANUAL FOR FUTURE REFERENCE.
KEEP AWAY FROM CHILDREN.**

Maximum initial battery voltage (measured without a load)
is 20 volts. Nominal voltage is 18 volts.



**WEAR CSA APPROVED
EYE PROTECTION**



**WEAR EAR
PROTECTION**



**WEAR A
FACE MASK**

PRODUCT SPECIFICATIONS

HEDGE TRIMMER

Blade length	22" (56 cm)
Blade speed	2,800 SPM
Blade break time	< 1 second
Cutting capacity	3/4" (19 mm)
Weight	3.09 kg (with battery installed in tool)

BATTERY AND CHARGER

Battery voltage	20v 4.0Ah Li-ion (Maximum charged battery voltage, measured without load, is 20v with a nominal value of 18v)
Charger	Up to 2 hours
Replacement battery	5350-011
Replacement charger	5350-010

NEED ASSISTANCE?

Call us on our toll- free customer support line:
1-866-349-8665 (Monday through Friday 9am – 5pm Eastern Standard Time)

- Technical questions
- Replacement parts
- Parts missing from package

TABLE OF CONTENTS

Product Specifications	1
Table of Contents	2
General Safety Warnings	3
Electric Gardening Tool Safety	5
Specific Safety Rules	7
Battery & Charger Safety	11
Battery Pack Recycling & Symbols	12
Know Your Hedge Trimmer	13
Checking the Battery Charger Status / Assembly and Operating	14
Installing a Battery on the Brushless Hedge Trimmer	15
Installing the Blade Guard & Hand Guard	16
Operation of Trigger and Auxiliary Handle Switches	17
Carrying and Operating the Hedge Trimmer	18
Maintenance	20
Battery Pack Removal and Preparation for Recycling	21
Exploded View	22
Parts List	23
Warranty	24







GENERAL SAFETY WARNINGS



IMPORTANT SAFETY INSTRUCTIONS

Read and understand all safety and operational instructions. Failure to follow the safety rules listed below and other basic safety precautions may result in serious personal injury. Keep this manual, sales receipts, and applicable warranty forms for future reference.

SAFETY SYMBOLS

The purpose of safety symbols is to alert you of the potential safety RISKS. Recognize and understand them. Follow the instructions provided.

SYMBOL	MEANING
	<p>Failure to obey a DANGER safety alert WILL result in serious personal injury or death to you or to others. Always obey all messages following this symbol to reduce the risk of serious personal injury or death.</p>
	<p>Failure to obey a WARNING safety alert MAY result in serious personal injury or death to you or to others. Always obey all messages following this symbol to reduce the risk of potential serious personal injury or death.</p>
	<p>Failure to obey a CAUTION safety alert MAY result in personal injury or property damage to you or to others. Always obey all messages following this symbol to reduce the risk of personal injury or property damage.</p>
	<p>Failure to obey a NOTICE or a CAUTION (without a safety alert) MAY result in property damage to you or to others. Always obey all messages following this symbol to reduce the risk of property damage.</p>
	<p>ALWAYS WEAR EYE PROTECTION THAT CONFORMS WITH CSA Z94.3 or ANSI SAFETY STANDARD Z87.1</p> <p>FLYING DEBRIS can cause permanent eye damage. Prescription eyeglasses ARE NOT a replacement for proper eye protection. The usage of a safety standard compliant face shield placed over proper safety glasses or goggles can reduce the risk of facial injury.</p> <p>Non-compliant eyewear can cause serious injury if broken during the operation of a power tool.</p>
	<p>Use hearing protection, particularly during extended periods of operation of the tool, or if the operation is noisy.</p>
	<p>WEAR A DUST MASK THAT IS DESIGNED TO BE USED WHEN OPERATING A POWER TOOL IN A DUSTY ENVIRONMENT.</p> <p>Refer To Page 7 of this manual for California Prop 65 warnings relating to hazardous dust particles.</p>

SYMBOL	MEANING
<p>⚠ WARNING</p> 	<p>Always wear non-slip gloves that fit properly to protect your hands and to help you grip the tool.</p> <p>Always wear sturdy clothing with long sleeves and long pants. Never operate the tool while wearing shorts, short sleeve shirt or while shirtless.</p> <p>Always wear non-slip safety boots to prevent foot injuries and slipping that could cause loss of control of the tool.</p>
<p>⚠ WARNING</p> 	<p>To avoid electrical hazards, fire hazards or damage to the tool, use proper circuit protection.</p> <p>This tool is wired at the factory for 120 V AC operations. It must be connected to a 120 V AC, 15 A circuit that is protected by a time-delayed fuse or circuit breaker. To avoid shock or fire, replace power cord immediately if it is worn, cut or damaged in any way.</p>
	<p>WARNING: Ventilation openings in batteries and chargers must always be open to allow cooling air to circulate freely. Air vents that are blocked, restricted or covered may result in the battery or charger overheating. Overheating may lead to damage to the tool or cause a fire, resulting in possible serious injury.</p>

ELECTRIC GARDENING TOOL SAFETY

GENERAL SAFETY WARNINGS

 **WARNING:** Read all safety warnings and all instructions. Failure to follow the warnings and instructions may result in electric shock, fire and/or serious injury.

Save all warnings and instructions for future reference.

General Electric Gardening Tool Safety Warnings – Work Area Safety

Do not operate power tools in explosive atmospheres, such as in the presence of flammable liquids, gases or dust. Power tools create sparks which may ignite the liquids, fumes or dust.

Keep children and bystanders away while operating a power tool.

Distractions can cause you to lose control.

GENERAL ELECTRIC GARDENING TOOL SAFETY WARNINGS

– ELECTRICAL SAFETY

Battery charger plugs must match the outlet. Never modify the plug in any way. Do not use any adapter plugs with earthed (grounded) chargers. Unmodified plugs and matching outlets will reduce risk of electric shock.

Avoid body contact with earthed or grounded surfaces such as water pipes. There is an increased risk of electrical shock if your body is earthed or grounded.

Do not expose power tools, battery chargers or batteries to rain or wet conditions. Water entering the tool, chargers or batteries will increase the risk of electric shock.

Do not abuse the cord. Never use the power cord for carrying, pulling or unplugging the charger. Keep the power cord away from heat, oil, sharp edges, and moving parts. Damaged or entangled cords increase the risk of electric shock.

When operating the charger outdoors, use an extension cord suitable for outdoor use. Use of a cord suitable for outdoor use reduces the risk of electric shock.

Never operate a power tool in the rain.

If operating a charger in a damp location is unavoidable, use a residual current device (RCD) protected supply. An RCD is also known as a ground fault circuit interrupter (GFCI) or earth leakage circuit breaker (ELCB). Use of an RCD reduces the risk of electric shock.

GENERAL ELECTRIC GARDENING TOOL SAFETY WARNINGS

– PERSONAL SAFETY

Stay alert, be aware of your surroundings, watch what you are doing and use common sense when operating a power tool. Do not use a power tool while you are tired or under the influence of drugs, alcohol, or medication. A moment of inattention while operating a power tool may result in serious personal injury.

Use personal protective equipment. Always wear eye protection. Protective equipment such as dust mask, non-skid safety shoes or boots, sturdy gloves, durable long pants, long sleeve shirt and hearing protection will reduce the risk of personal injuries.

Prevent unintentional starting. Ensure the switches are in the off-position before connecting the battery to the power tool or plugging it into the power supply. Never pick up or carry the power tool with your finger on the trigger switch. Carrying power tools with your finger on the switch or energizing power tools that have the switch on invites accidents.

Remove any adjustment key or wrench before turning the power tool on.

A wrench or a key left attached to a rotating part of the power tool may result in personal injury.

Do not overreach. Keep proper footing and balance at all times.

This enables better control of the power tool in unexpected situations.

Dress properly. Do not wear loose clothing or jewellery. Keep your hair, clothing and gloves away from moving parts. Loose clothing, jewellery or long hair can be caught in moving parts.

Do not force the tool. Use the correct tool for the application. The correct power tool will do the job better and safer when used at the rate for which it was designed.

Do not use a power tool if the switch does not turn it on or off. Any power tool that cannot be controlled using the switch is dangerous and must be repaired.

Remove the battery from the power tool or the plug from the power source before making any adjustments, replacing or repairing parts, cleaning the tool, leaving the tool idle or unattended, transporting or storing the tool. Such preventive safety measures reduce the risk of starting the power tool accidentally.

Store idle power tools out of the reach of children and do not allow persons unfamiliar with the power tool or these instructions to operate the power tool. Power tools are dangerous in the hands of untrained users.

Maintain power tools. Check for misalignment or binding of moving parts, breakage of parts and any other condition that may affect the power tool's operation. If damaged, have the power tool repaired before use.

Many accidents are caused by poorly maintained power tools

Use the power tool and accessories in accordance with these instructions, taking into account the working conditions and the work to be performed.

Use of the power tool for operations different from those intended could result in a hazardous situation.

GENERAL ELECTRIC GARDENING TOOL SAFETY WARNINGS

– SERVICE

Have your power tool or charger serviced by a qualified repair person using only identical replacement parts. This will ensure that the safety of the power tool or charger is maintained.

SPECIFIC SAFETY RULES

-  **WARNING:** Some dust created by power sanding, sawing, grinding, drilling, and other construction activities contain chemicals known to cause cancer, birth defects, or other reproductive harm. Some samples of these chemicals are:
- lead from lead-based paints,
 - crystalline silica from bricks and cement and other masonry products, and
 - arsenic and chromium from chemically-treated lumber.

Your risk from these exposures varies, depending on how often you do this type of work. To reduce your exposure to these chemicals: work in a well-ventilated area, and work with approved safety equipment, such as those dust masks that are specially designed to filter out microscopic particles.



-  **WARNING:** Know your hedge trimmer. Do not plug in the charger or install the battery onto the hedge trimmer until you have read and understand this Instruction Manual. Learn the tool's applications and limitations, as well as the general and specific potential hazards related to this tool. Following these instructions will reduce the risk of electric shock, fire or serious injury.



-  **WARNING:** Always wear appropriate eye protection. Any power tool can throw foreign objects into your eyes and cause permanent eye damage. ALWAYS wear appropriate safety goggles or properly fitted safety glasses that comply with the most recent version of ANSI Z87.1 safety standards. Ordinary vision or sun glasses generally do not provide adequate impact or side shield / wrap around penetration protection. Ordinary glasses ARE NOT safety glasses. To reduce the risk of injury to your face you should also wear a face shield over your safety goggles or safety glasses.



-  **WARNING:** Glasses, goggles or face shields not in compliance with ANSI Z87.1 or CAN/CSA – Z94.3 could cause serious injury if they break upon impact.





-  **WARNING:** Prevent foot injuries! Never operate when barefoot, or wearing open toed shoes, or sandals. Always, wear sturdy protective shoes or boots with non-slip soles when operating the hedge trimmer. Steel-toed safety boots are recommended.





-  **WARNING:** Protect your hands by wearing heavy-duty, non-slip gloves and to improve your grip and control when handling the hedge trimmer.





-  **WARNING:** Clothing must be durable and snug-fitting, yet allow for freedom of movement.

 **WARNING:** Avoid loose clothing such as scarves, neckties, jewellery, flared or cuffed pants, loose-fitting shirts or jackets, unconfined long hair or anything that can be pulled into the air intake of the hedge trimmer. Secure hair to above shoulder level. Wear long pants of durable material to protect your legs. Cover as much of your body as possible to help protect you from debris and pieces of toxic and allergenic plants being thrown by the hedge trimmer.

 **WARNING:** Use hearing protection such as ear plugs or ear muffs to protect your hearing, particularly if the hedge trimmer is used for extensive periods or if the surrounding environment of operation exposes the operator to loud noises. When wearing hearing protection, you will have impaired ability to hear alarms, warnings and shouts from approaching people or approaching vehicles. Be extra diligent and observant of hazards and bystanders when wearing hearing protection devices. When someone approaches, turn the hedge trimmer OFF immediately.

 **WARNING:** Protect your breathing. Always wear breathing protection when operating the hedge trimmer.

 **WARNING:** Breathing asbestos or dust with silica in its composition may contain hazardous crystalline silica. Silica is a fundamental component of sand, quartz, brick, clays, granite and many other materials and rocks, including masonry, concrete and cement products. Such crystalline silica dust is dangerous and must be avoided, as it can cause severe or fatal respiratory illness or cancer.

 **WARNING:** Inspect the area to be cleared for hazards before each use. Remove any foreign objects such as sticks, stones, sand, wire fences, fallen branches, cuttings and live wires which can be contacted by the hedge trimmer.

 **WARNING:** The blade guard must be installed on the hedge trimmer at all times except when the hedge trimmer is being operated. Carrying or storing the hedge trimmer without the blade guard installed may result in serious personal injury.

 **DANGER:** Keep hands away from the cutting blades. Contact with the cutting blades will result in serious personal injury.

 **DANGER:** The hedge trimmer cutting blades will continue to move after the switches are turned OFF. Wait for the cutting blades to come to a complete stop before removing the battery pack.

⚠️ WARNING: The hedge trimmer cutting blades will continue to move after the switches are turned OFF. Wait for the cutting blades to come to a complete stop before removing the battery pack.

Never allow children or untrained persons to use the hedge trimmer.

Never leave the hedge trimmer out in the rain.

Never use the hedge trimmer in wet conditions or in rain. The water will damage the motor. It will also create very unsafe working conditions.

Always be aware of obstacles such as roots, stumps and holes which could cause you to trip.

Never walk backwards while the hedge trimmer is turned ON as you might trip and may not hear approaching persons or vehicles.

⚠️ WARNING: Always wear gloves when handling the cutting blade for removal of foreign objects that may be jammed in the cutting blades.

Use both hands when operating the hedge trimmer. Using one hand could cause loss of control and result in serious personal injury.

Keep all parts of the body away from the cutter blade. Do not remove cut material or hold material to be cut when blades are moving.

When transporting (even for short distances), leaving the tool idle or unattended, or storing the hedge trimmer always carefully fit the protective blade guard over the cutting blades.

Carry the hedge trimmer by the forward assist handle with the cutting blades stopped and the cutting blades facing rearward. Proper handling of the hedge trimmer will reduce the risk of injury from the cutting blades.

Use this hedge trimmer only with the battery pack specified in this manual. Use of any other battery pack may create a risk of injury and fire.

⚠️ WARNING: Only use the hedge trimmer with the handle and guard in good condition and properly assembled to the hedge trimmer. The use of the hedge trimmer without the proper guard and handle provided may result in serious personal injury.

Recharge the battery pack using only the charger specified in this manual. A charger that is suitable for another type of battery pack may create a risk of fire.

When the battery pack is not in use, keep it away from other metal objects like paper clips, coins, keys, nails, screws or other small metal objects that can make a connection from one terminal to the other. Shorting the battery pack terminals together may cause burns or a fire.

⚠️ WARNING: Hold the hedge trimmer by the insulated rear main handle and the insulated front assist handle because the cutting blades may contact hidden wiring. Cutting blades contacting a "live" wire may make exposed metal parts of the hedge trimmer "live" and could give the operator an electric shock.

Never modify the hedge trimmer or use unauthorized parts or attachments. Doing so is dangerous. It will also void the warranty.

Always be aware of your surroundings and stay alert for possible hazards of which you may not be aware due to the noise of the operating hedge trimmer.

⚠ WARNING: Beware of overhead power lines.

Before operating the hedge trimmer, inspect the cutting blades to ensure they are securely mounted, clean, sharp and in good condition (not warped).

Never cut in areas you cannot see completely. Unseen hazards will be dangerous.

Use only in daylight or in good quality artificial light.

Before operating the hedge trimmer, check the trigger switches to make sure they are functioning freely.

Avoid operating the hedge trimmer while people, children and pets are nearby.

If the cutting blades strike a foreign object of the hedge trimmer starts making any unusual noise or vibration, turn the switches OFF, wait for the cutting blades to stop and remove the battery pack. Tighten any loose parts and inspect the tool for damage. Replace any damaged parts with identical replacement parts.

Do not use the hedge trimmer with damaged or excessively worn cutting blades.

Always grasp the hedge trimmer using the forward assist handle and the rear mainhandle on the machine.

Maintain firm footing and balance at all times. Do not overreach or use the hedge trimmer from unstable surfaces such as from upon ladders, trees, steep slopes, slippery surfaces, rooftops, etc.

Always make sure the cutting blades are pointed away from your body during operation.

Never clean the hedge trimmer with any liquid. Use a dry cloth to wipe it down.

Never use a pressure washer, garden hose or any other liquid to clean the hedge trimmer.

Always keep the handles clean and dry. Handles that are wet, covered with grease, chemicals or debris will make holding onto the hedge trimmer difficult. Use a clean cloth dampened with plain water to clean these surfaces.

When transporting the hedge trimmer in a vehicle, make sure it is well secured.

Sudden turns or stopping could cause the hedge trimmer to slide or roll, causing damage to the vehicle or cause personal injury, or damage to the tool.

SERVICE

Have your hedge trimmer serviced by a qualified repair person using only identical replacement parts. This will ensure the safety of the hedge trimmer is maintained.

MAINTENANCE & STORAGE SAFETY

When the hedge trimmer is being stopped for servicing, inspection, transport or storage, turn the switches OFF, wait for the cutting blades to come to a complete stop and remove the battery pack. This action will limit the possibility of being injured by inadvertent movement of the cutting blades.

BATTERY & CHARGER SAFETY

⚠️ WARNING: Only use the diagnostic charger supplied with this kit to charge the 20V Li-ion battery. Charging any other batteries may damage the charger and possibly cause serious injury.

Do not store or carry the battery in a manner in which metal objects could contact the exposed metal end. Do not place the battery in aprons, pockets, drawers, etc. with loose nails, screws, keys etc. The battery could short circuit causing a fire, personal injury or damage to the battery.

Never attempt to open the battery for any reason. If the housing of the battery breaks or cracks, immediately discontinue use and do not recharge.

Do not charge the battery if it is wet or shows any evidence of corrosion.

A small leakage from the battery may occur under extreme usage, charging or temperature conditions. This does not indicate a failure. However, if the outer seal is broken and this leakage gets on your skin, follow these steps:

1. Wash immediately with soap and water.
2. Neutralize with a mild acid such as lemon juice or vinegar.
3. If liquid gets into your eyes, flush immediately with clean water for a minimum of 10 minutes and seek medical attention.

NOTE: The battery liquid is slightly acidic.

Do not incinerate the battery. It can explode in a fire.

Do not use an extension cord. Plug the charger cord directly into an electrical outlet.

Use the charger only in a standard 120V, 60 Hz electrical outlet.

Do not use the charger in wet or damp conditions. It is intended for indoor use only.

Do not use the charger near sinks or tubs. Do not immerse the charger in water.

Do not allow the cord to hang over the edge of a table or counter or touch hot surfaces. The charger should be placed away from sinks and hot surfaces.

Do not use the charger to charge any batteries other than the hedge trimmer batteries. Other batteries may explode.

Do not operate charger if the cord or plug is damaged. Replace the damaged cord and plug immediately.

Do not operate the charger if it has received a sharp blow, been dropped or otherwise damaged in any way. Have a qualified technician examine the charger and repair it if necessary. Do not disassemble the charger.

Do NOT charge the batteries when the work area or the battery temperature is at or below 41° F/ 5° C) or above 105° F/ 40.5° C

Unplug the charger when not in use and before cleaning or maintenance.

BATTERY PACK RECYCLING



To preserve our natural resources, please recycle or dispose of batteries properly. The batteries charged by this charger may contain chemicals and metals that are harmful to the environment. Never dispose of rechargeable batteries in your normal household garbage or in landfill sites as they will add to the pollution of the environment.

SYMBOLS

The rating plate on your tool may show these symbols. These represent important information about the product or instructions on its use.

V	Volts
A	Amperes
HZ	Hertz
W	Watts
H	Hours
	Direct current
	Alternating or direct current
	Warning symbol
	Shock hazard
	Hand hazard
	Blower hazard
	Keep bystanders back at least 50' (15 m)

	Read the manual
	Wear safety glasses
	Wear safety goggles
	Wear full-face shield
	Wear hearing protection
	Wear breathing protection
	Wear safety gloves
	Wear safety boots
	Wear snug fitting clothing
	Risk of fire



This symbol designates that this tool is listed with U.S. requirements by MET Laboratories, Inc.

Conforms to UL 62841-1, UL62841-4-2

Certified to CAN/CSA STD C22.2 No.62841-1:15, CAN/CSA-C22.2 No.62841-4-2:19.

E114847
JD5512

KNOW YOUR BRUSHLESS HEDGE TRIMMER

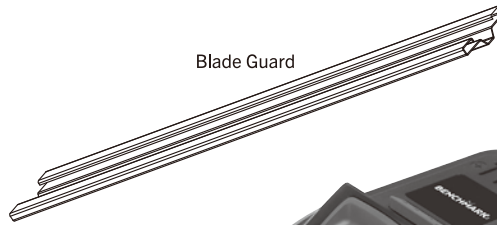
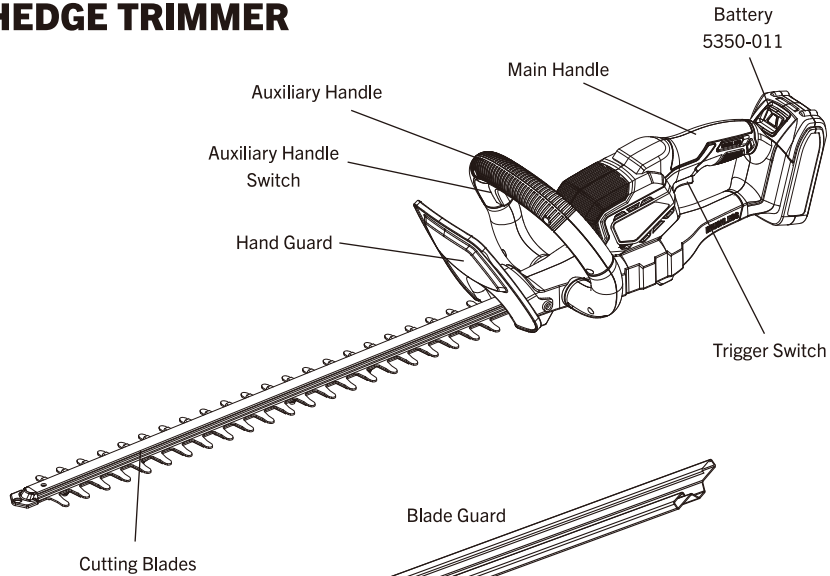

CHECKING THE BATTERY CHARGE STATUS

The level of charge remaining in the battery can be checked by using the battery LED power indicator that is contained on the end of the battery.

NOTE: The battery charge remaining may be checked while the battery is installed in the tool with the ON/OFF switch turned OFF. It may also be checked while the battery is removed from the tool. **DO NOT** check the battery charge remaining while the battery is in the charger. You will get a false reading and you may also damage the battery status system.

1. Press and hold the battery status button located on the end of the battery
2. One or more of the Four LED lights in the LED window will come ON to indicate the amount of charge that is remaining in the battery as follows:



Charge level indicator				
Amount of charge remaining	10-25%	25-50%	50-75%	75-100%

3. Release the battery status button to turn the LEDs OFF.

ASSEMBLY AND OPERATING

CHARGING THE BATTERY PACK

1. Place the battery charger (1) in a dry location near a 110–120V 60 Hz electrical outlet (Fig. 2).
2. Plug the battery charger into the outlet and make sure the green LED indicator light (5) comes ON. If it does not, refer to the chart (Fig. 3) to identify the problem.
3. Turn the battery (2) upside down and slide it onto the charger.

NOTE: Make sure the grooves (3) in the sides of the battery slide over the matching tabs on the charger (4) until the battery latch “clicks” into place.

NOTES:

1. When the charger is plugged into the wall receptacle and NO battery is on the charger, the green indicator light (5) will turn ON indicating the charger is “live”.
2. When a discharged battery is installed on the charger, the green indicator light will turn OFF and the red indicator light (6) will turn ON. The red indicator light indicates the battery is being charged.
3. If the red indicator light does not come ON, check to make sure battery pack is slid fully onto the charger and the electrical outlet is working properly.

4. See Fig. 3 below for other indicator light functions.
5. A discharged battery pack should be fully charged in approximately 2 hours.
6. It is normal for the battery charger to hum and be warm to the touch during operation.
7. If the battery pack does not charge properly, check to make sure the electrical outlet is "live".
8. Do NOT charge batteries when the work area or the battery temperature is at or below 5°C / 41°F or above 40.5°C / 105°F.



FIG. 2

GREEN LIGHT	RED LIGHT	BATTERY INSERTED INTO CHARGER	CHARGING STATUS
ON	OFF	NO	Charger connected to power supply
OFF	Blink	YES	Battery being charged
ON	OFF	YES	Battery fully charged
OFF	ON	YES	Battery is charged but not operational on tool. This may indicate defective / bad contact on battery.
ON	ON	YES	Charging conditions are either too hot or too cold

FIG. 3

INSTALLING A BATTERY ON THE BRUSHLESS HEDGE TRIMMER

1. Remove the discharged battery (1) from the brushless hedge trimmer by pressing downward on the battery release button (2) and sliding the battery backward until it is removed from the brushless hedge trimmer port (3) (Fig. 4).
2. Slide the fully charged battery onto the matching keys (4) in the brushless hedge trimmer port (3) where the discharged battery has been removed.

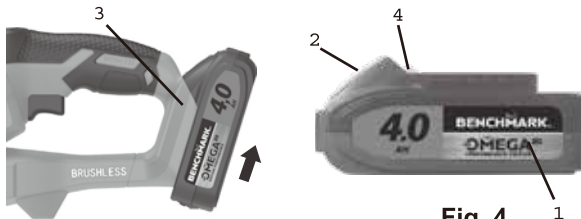

Fig. 4

NOTE: Make sure the slots in the battery are fully engaged with the mounting keys in the cordless power washer (3). The battery release button will "click" into place when the battery is fully installed.

WARNING: Do not immerse the battery pack in water. Sudden cooling could cause a hot battery to explode or leak.

INSTALLING THE BLADE GUARD

! WARNING: The blade guard must be installed on the hedge trimmer at all times except when the hedge trimmer is being operated. Carrying or storing the hedge trimmer without the blade guard installed may result in serious personal injury.

1. Slide the blade guard (1) over the cutting blades (2) (Fig. 6).
2. Make sure the blade guard slides fully onto the cutting blades to ensure all cutting teeth are covered (Fig.7).

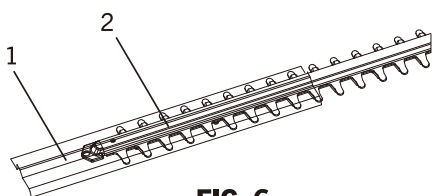

FIG. 6

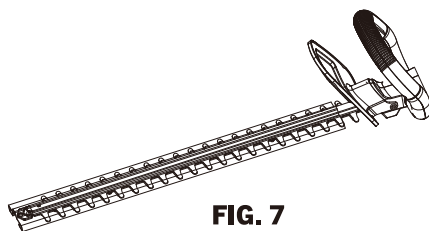

FIG. 7

INSTALLING THE HAND GUARD (IF NOT INSTALLED ON TOOL)

! WARNING: The hand guard must be in place before the hedge trimmer is operated. Without this guard in place, serious injury could result.

1. Slide the open end of the hand guard (1) down over the blade and back over the blade mount (2) (Fig. 7a).
2. Thread two self-tapping screw (3) through the hand guard and into the matching holes (4) in each side of the blade mount Fig 7b).

NOTE: Use a #2 screwdriver. Make sure the hand guard is held firmly in place by the screws, but do not over tighten.

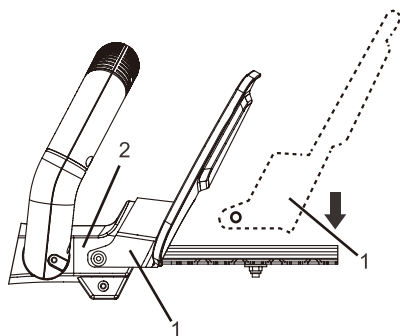

FIG. 7a

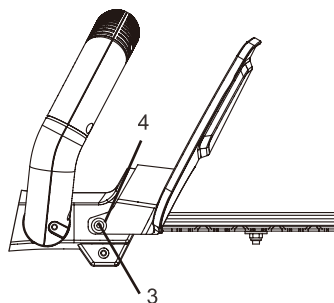

FIG. 7b

OPERATION OF TRIGGER AND AUXILIARY HANDLE SWITCHES

⚠ DANGER: Prior to activating the switches, be sure to be securely holding the hedge trimmer with both hands, one on each of the two handles. Keep your hands and body parts away from the cutting blades.

The hedge trimmer is equipped with both a trigger switch and an auxiliary handle switch. To turn the hedge trimmer ON:

Hold the tool by the auxiliary handle (1) Fig. 8 ensuring you are squeezing to activate the switch and then with the other hand simultaneously squeeze the trigger switch (2) Fig 8.

NOTE: Both switches must be depressed at the same time to operate the tool.

1. To turn the hedge trimmer OFF, release the trigger switch.

⚠ WARNING: When the trigger switches are released, the hedge trimmer will "coast" for approximately 1 second before it comes to a complete stop or "brakes".

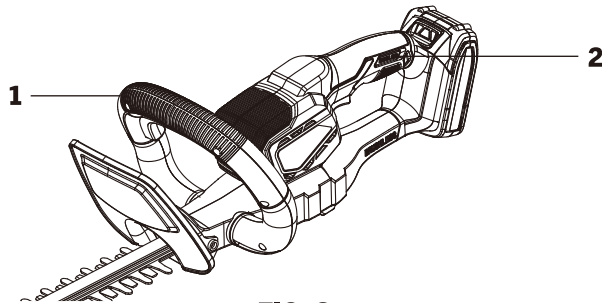

FIG. 8

⚠ WARNING: For safety reasons, the operator must read the sections of this Owner's Manual entitled GENERAL SAFETY WARNINGS, ELECTRIC GARDENING TOOL SAFETY, SPECIFIC SAFETY RULES, BATTERY & CHARGER SAFETY, BATTERY PACK RECYCLING and SYMBOLS before using this hedge trimmer.

Verify the following every time the hedge trimmer is used:

1. Safety glasses or goggles, hearing protection device, hearing protection and all required safety clothing are being worn.
2. The area of operation is cleared of all dangerous debris such as broken glass and free of materials that could derive hazardous dust.
3. Bystanders are at least 50' (15 m) away from the operation area.

Failure to observe these safety rules will significantly increase the risk of injury.

CARRYING THE HEDGE TRIMMER

⚠ WARNING: Always remove the battery pack from the hedge trimmer and install the blade guard when transporting it from one location to another, even if it is a short distance.

Once you have removed the battery pack and installed the blade guard, grasp the auxiliary handle with one hand facing backward (Fig. 9). Always carry the hedge trimmer with the blades facing behind your legs to avoid them contacting any part of your legs.

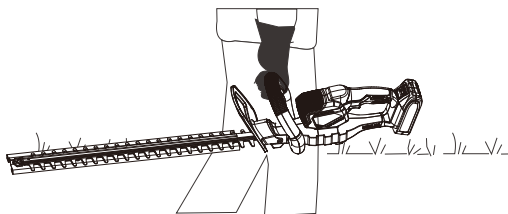

FIG. 9

CUTTING THE VERTICAL SIDES OF THE HEDGE

To cut the vertical sides of the hedge, swing the blade upward from the bottom of the hedge in an arc (Fig. 10). Repeat the arc motion by lowering the blade to the bottom of the hedge and swinging it upward in an arc again to make the cut. Gradually move forward as the hedge is trimmed to the desired amount.

NOTE: Cutting the sides of a tall hedge where your arms are raised above head height is very tiring. To avoid fatigue and possible injury, only work in the overhead position for short periods of time. Take a break often to avoid fatigue.

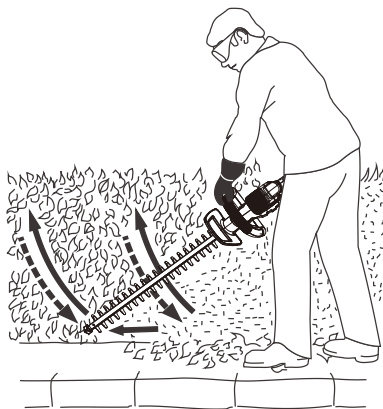

FIG. 10

CUTTING THE HORIZONTAL TOP OF THE HEDGE

When cutting the horizontal top of the hedge, hold the cutting blades at a 0° – 10° angle to the top surface of the hedge (Fig. 11). Swing the cutting blades in an arc back and forth across the top of the hedge. Use both edges of the cutting blades, changing the 0° – 10° angle with each change in cutting direction.

NOTE: Swing the cutting blades in an arc towards the outside edges of the hedge to assist in sweeping the cuttings off the horizontal surface.

When cutting the top of a wide hedge, repeat the above procedure until the complete width of the hedge has been trimmed (Fig. 12).

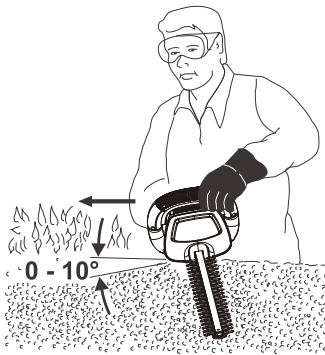

FIG. 11

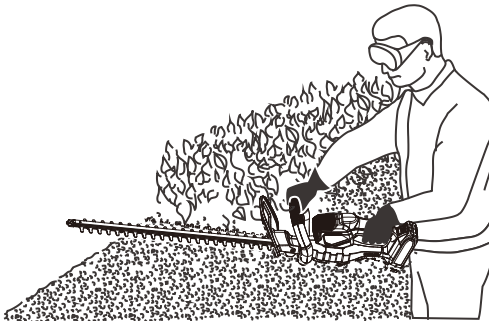



FIG. 12

MAINTENANCE

GENERAL

 **WARNING:** When servicing, use only identical replacement parts. The use of any other parts may create a hazard or cause product damage.

DO NOT use solvents when cleaning plastic parts. Plastics are susceptible to damage from various types of commercial solvents and may be damaged by their use. Use a clean cloth to remove dirt, dust, oil, grease etc.

 **WARNING:** Do not allow brake fluids, gasoline, petroleum-based products, penetrating oils, etc. to come into contact with plastic parts. They contain chemicals that can damage, weaken or destroy plastic.

DO NOT abuse power tools. Abusive practices can damage the tool and the workpiece.

 **WARNING:** DO NOT attempt to modify tools or create accessories. Any such alteration or modification is misuse and could result in a hazardous condition leading to possible serious injury. It will also void the warranty.

HEDGE TRIMMER MAINTENANCE AND STORAGE

Always clean the hedge trimmer immediately after use. Never use water or chemical cleaners to clean the unit. Brush blade using a stiff nylon brush to remove any debris. Wipe unit clean with a dry cloth.

Always store the unit in a dry place.

Inspect the trimmer before each use.

The blade rail should be cleaned and treated with fine oil after each use.

Use the blade guard for transportation and storage

Have the unit professionally repaired if any damage occurs.

BATTERY PACK REMOVAL AND PREPARATION FOR RECYCLING

To preserve our natural resources, please recycle or dispose of batteries properly.

The batteries accompanying this tool may contain chemicals and metals that are harmful to the environment. Never dispose of rechargeable batteries in your normal household garbage or in landfill sites, because they will add to the pollution of the environment.

Consult your local waste authority for information regarding available recycling and disposal options.

 **WARNING:** Upon removal of the battery pack, cover the terminals of the battery pack with electrical tape or heavy-duty adhesive tape. Never touch both terminals with metal objects or body parts, because a short circuit may result. Keep away from children. Do not attempt to destroy or disassemble battery pack or remove any of its components. Rechargeable batteries must be recycled or disposed of properly. Failure to comply with these warnings could result in fire and serious injury.

EXPLODED VIEW

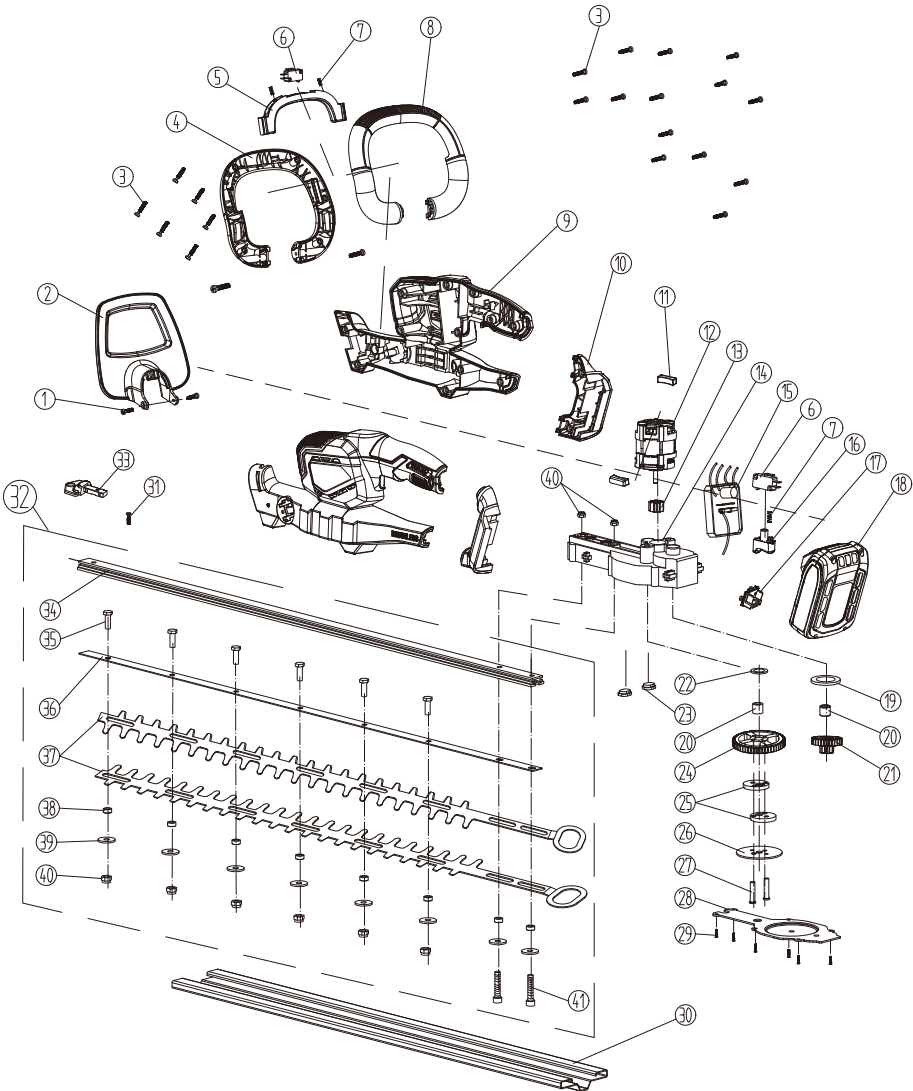

PARTS LIST

⚠ WARNING: When servicing, use only original equipment replacement parts. The use of any other parts may create a safety hazard or cause damage to the hedge trimmer.

Any attempt to repair or replace electrical parts on this hedge trimmer may create a safety hazard unless repairs are performed by a qualified technician. For more information, call the Toll-free Helpline, at 1-866-349-8665 – Friday from 9am to 5pm Eastern Standard Time.

Always order by PART NUMBER, not by key number.

Key #	Part #	Part Name	Quantity
1	4030010096	ST3.9*12 Screw	2
2	3160040098	Hand Protection Guard	1
3	4030010102	ST3.9*16 Screw	22
4	3120070153	JD5512 Front Grip Up Housing	1
5	3120010144	Front Switch	1
6	1062010021	Switch	2
7	2050060218	Spring of Switch	3
8	3120070154	JD5512 Front Grip Lower Housing	1
9	3010090003	JD5512 Housing	1
10	3010090004	JD5512 Foot Plate	1
11	3140060059	Motor Plate	2
12	1030300011	Brushless Motor	1
13	2010010133	JD5502 Motor Gear	1
14	1180080006	JD5502 Center Support	1
15	1130030097	Brushless Motor PCB Controller	1
16	3120010143	Switch Button	1
17	3150170016	Terminal Plate	1
18	1290090046	Battery Pack	1
19	2030020347	Washer 1	1
20	4010020002	Needle Roller Bearing	2
21	2010010134	Intermediate Gear	1
22	2030020346	Washer 2	1
23	3140020131	Sealing Washer	2
24	2010010135	Big Gear	1
25	2010130051	Eccentric Plate	2
26	2030030267	Plate	1
27	2040160206	Rivet	2

28	2030030266	Cover Plate	1
29	4030010031	ST2.9X14 Screw	6
30	3160040099	Blade Sleeve	1
31	4030010020	ST2.9X6 Screw	1
32	1150010062	Blade Assembly	1
33	3150160221	Hook	1
34	/	Blade Cover	1
35	/	M5X14 bolt	6
36	/	Blade Cushion	1
37	/	Blade	2
38	/	Bushing	8
39	/	Washer 3	8
40	4060090019	M5X5 Bolt	8
41	4020080077	M5X25 Screw	2

WARRANTY

BENCHMARK BRUSHLESS HEDGE TRIMMER WARRANTY

If this Benchmark tool fails due to a defect in material or workmanship within five years from the date of purchase, return it to any Home Hardware store with the original bill of sale for exchange. 3 Year warranty for the battery and charger.

This warranty does not include expendable parts including but not limited to blades, brushes, belts, light bulbs. This warranty covers defects in material or workmanship only. It does not cover normal wear and tear, failure due to abuse/misuse, or defects caused by careless or accidental mishandling. If this Benchmark product is used for commercial or rental purposes, this warranty does not apply.

20V MAX BRUSHLESS HEDGE TRIMMER

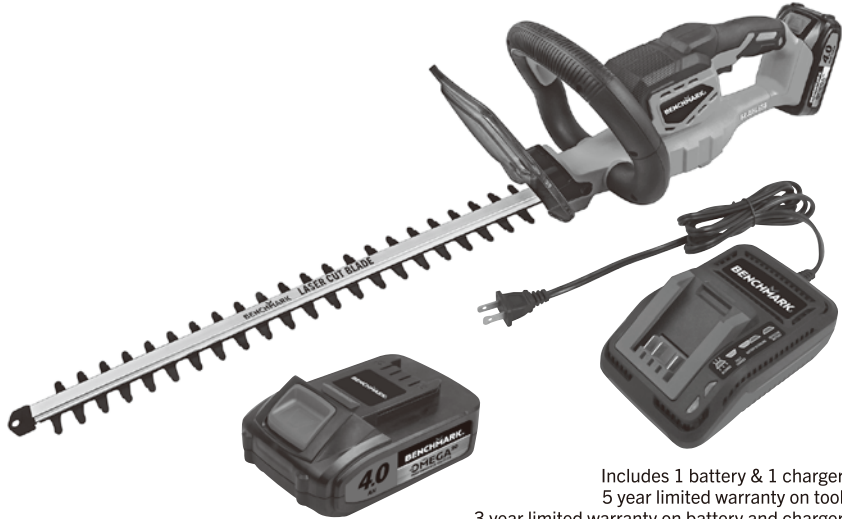

Includes 1 battery & 1 charger
5 year limited warranty on tool
3 year limited warranty on battery and charger

BENCHMARKTM
MC

BENCHMARK TOOLS CANADA
ST. JACOBS, ONTARIO N0B 2N0
© 2020 Home Hardware Stores Limited

CUSTOMER SERVICE/TECH SUPPORT
1-866-349-8665

5073-044

Made in China



*This BenchmarkTM product carries a five (5) year LIMITED warranty against defects in workmanship and materials. The charger and batteries carry a three (3) year LIMITED warranty. See Owner's Manual for full details.



E114847
JD5512

READ ALL INSTRUCTIONS BEFORE FIRST USE.
KEEP THIS MANUAL FOR FUTURE REFERENCE.
KEEP AWAY FROM CHILDREN.

Maximum initial battery voltage (measured without a load)
is 20 volts. Nominal voltage is 18 volts.



**WEAR CSA APPROVED
EYE PROTECTION**



**WEAR EAR
PROTECTION**



**WEAR A
FACE MASK**