

Radley®

40V Max* Lawn Mower



3 Year limited warranty (for tool)
and 2 year limited warranty
(for the battery and charger).

Owner's
Manual



20V + 20V = 40V



**READ ALL INSTRUCTIONS BEFORE FIRST USE.
KEEP THIS MANUAL FOR FUTURE REFERENCE.
KEEP AWAY FROM CHILDREN.**

*Uses two 20V Max lithium-ion batteries that deliver an initial battery voltage (measured without a workload) of 40 volts. Nominal voltage is 36V.

PRODUCT SPECIFICATIONS

17" 40V BRUSHLESS LAWN MOWER	
Voltage	40V (2 x 20V) No Load
No load	3300 RPM
Clearing Width	15-3/4" (40cm)
Bag Capacity	45L (11.9 gal)
Weight	31.7 lbs (14.4kg)

BATTERY AND CHARGER	
Battery voltage:	2x20V 5 Ah Li-ion (Maximum charged battery voltage, measured without load, is 20V with a nominal value of 18V)
Dual Charger	Up to 180 minutes
Replacement battery	5350-014
Replacement charger	5350-046

Need Assistance?

Call us on our toll free customer support line:

1-866-349-8665 (Monday through Friday 9am – 5pm Eastern Time)

- Technical questions
- Replacement parts
- Parts missing from package

TABLE OF CONTENTS

Product specifications	1
Table of contents	2
General safety warnings	3
Electrical safety	3-4
Lawn mower safety	4-6
Battery Pack & Charger Safety	6-8
Recycling and disposal	9
Symbols	10-12
Know your lawn mower	13
Assembly	14-17
Operation	17-20
Maintenance	21-23
Exploded view	24
Parts list	25-27
Warranty	28

GENERAL SAFETY WARNINGS

IMPORTANT SAFETY INSTRUCTIONS

Read and understand all safety and operational instructions. Failure to follow the safety rules listed below and other basic safety precautions may result in serious personal injury. Keep this manual, sales receipts and applicable warranty forms for future reference.

⚠ WARNING: Before using this tool or any of its accessories, read this manual and follow all safety rules and operating instructions. The important precautions, safeguards and instructions appearing in this manual are not meant to cover all possible situations. It must be understood that common sense and caution are factors which cannot be built into the product.

EYE, EAR & LUNG PROTECTION



ALWAYS WEAR EYE PROTECTION THAT CONFORMS WITH CSA REQUIREMENTS OR ANSI SAFETY STANDARD Z87.1

FLYING DEBRIS can cause permanent eye damage. Prescription eyeglasses are not a replacement for proper eye protection.

⚠ WARNING: Noncompliant eyewear can cause serious injury if broken during the operation of a garden tool.

⚠ WARNING: Use hearing protection, particularly during extended periods of operation of the tool, or if the operation is noisy.



WEAR A DUST MASK THAT IS DESIGNED TO BE USED WHEN OPERATING A GARDON TOOL IN A DUSTY ENVIRONMENT.

⚠ WARNING: Dust that is created by power sanding, sawing, grinding, drilling, and other construction activities may contain chemicals that are known to cause cancer, birth defects, or other genetic abnormalities. These chemicals include:
Lead from lead-based paints.

Crystalline silica from bricks, cement, and other masonry products. Arsenic and chromium from chemically treated lumber.

The level of risk from exposure to these chemicals varies, according to how often this type of work is performed. In order to reduce exposure to these chemicals, work in a well-ventilated area, and use approved safety equipment, such as a dust mask that is specifically designed to filter out microscopic particles.

ELECTRICAL SAFETY



WARNING: To avoid electrical hazards, fire hazards or damage to the tool, use proper circuit protection.

SAVE THESE INSTRUCTIONS FOR REFERENCE



WARNING: Ventilation openings in batteries and chargers must always be open to allow cooling air to circulate freely. Air vents that are blocked, restricted or covered may result in the battery or charger overheating. Overheating may lead to damage to the tool or cause a fire, resulting in possible serious injury.

LAWN MOWER SAFETY

SAFETY WARNINGS

1. This product is not intended for use by persons (including children) with reduced physical, sensory or mental capabilities, or lack of experience and knowledge, unless they have been given supervision or instruction concerning use of the product by a person responsible for their safety.
2. Children should be supervised to ensure that they do not play with the product. Cleaning and user maintenance shall not be made by children without supervision.

SAFETY WARNINGS FOR BATTERY POWERED LAWN MOWER OPERATION

1. Read the instructions carefully. Be familiar with the controls and the proper use of the product.
2. Never allow children or people unfamiliar with these instructions to use the product. Local regulations can restrict the age of the operator.
3. Never mow while people, especially children, or pets are nearby.
4. Keep in mind that the operator or user is responsible for accidents or hazards occurring to other people or their property.

PREPARATION

1. While mowing, always wear substantial footwear and long trousers. Do not operate the product when barefoot or wearing open sandals. Avoid wearing clothing that is loose fitting or that has hanging cords or ties.
2. Thoroughly inspect the area where the product is to be used and remove all objects which can be thrown by the product.
3. Before using, always visually inspect to see that the cutting device, cutting device bolts and cutting device assembly are not worn or damaged. Replace worn or damaged cutting devices and bolts in sets to preserve balance. . Replace damaged or unreadable labels.

OPERATION

1. Operate the product in daylight or in good artificial light.
2. Avoid operating the product in wet grass, where feasible.
3. Always be sure of your footing on slopes.
4. Walk, never run.

READ ALL INSTRUCTIONS BEFORE USING THIS 40V BRUSHLESS LAWN MOWER

5. Mow across the face of slopes, never up and down.
6. Exercise extreme caution when changing direction on slopes.
7. Do not mow excessively steep slopes.
8. Use extreme caution when reversing or pulling the product towards you.
9. Stop the cutting device(s) if the product has to be tilted for transportation when crossing surfaces other than grass, and when transporting the product to and from the area to be mowed.
10. Never operate the product with defective guards, or without safety devices, for example deflectors and/or grass catchers, in place.
11. Start the product or switch on the product carefully according to instructions and with feet well away from the cutting device(s).
12. Do not tilt the product when switching on the motor, except if the product has to be tilted for starting. In this case, do not tilt it more than absolutely necessary and lift only the part, which is away from the operator.
13. Do not start the product when standing in front of the discharge chute.
14. Do not put hands or feet near or under rotating parts. Keep clear of the discharge opening at all times.
15. Never pick up or carry a product while the safety key is inserted.
16. Stop the machine, and remove the disabling device. Make sure that all moving parts have come to a complete stop.
 - Whenever you leave the product.
 - Before clearing blockages or unclogging chute.
 - Before checking, cleaning or working on the product.
 - After striking a foreign object. Inspect the machine for damage and make repairs before restarting and operating the product; if the product starts to vibrate abnormally (check immediately).
 - Inspect for damage.
 - Replace or repair any damaged parts.
 - Check for and tighten any loose parts.

MAINTENANCE AND STORAGE

1. Keep all nuts, bolts and screws tight to be sure the product is in safe working condition.
2. Check the grass catcher frequently for wear or deterioration.
3. Be careful during adjustment of the product to prevent entrapment of the fingers between moving blades and fixed parts of the product.
4. Allow the product to cool before storing in any enclosure.
5. When servicing the blades be aware that, even though the power source is switched off, the blades can still be moved.
6. Replace worn or damaged parts for safety. Use only genuine replacement parts and accessories.

SAVE THESE INSTRUCTIONS FOR REFERENCE

7. Wear strong work gloves when removing and reassembling the cutting device.

BATTERY PACK & CHARGER SAFETY

BATTERY SAFETY INSTRUCTIONS

⚠ WARNING! Only use the charger supplied with this kit to charge the 20V Li-ion batteries for this tool. Charging any other batteries may damage the charger and possibly cause serious injury.

⚠ WARNING! Do not store batteries in a garage or shed over the winter as it will damage battery life.

1. **Recharge only with the charger specified by the manufacturer.** A charger that is suitable for one type of battery pack may create a risk of fire when used with another battery pack. Incorrect use may result in electric shock, overheating or leakage of corrosive liquid from the battery.
2. **Use machines only with specifically designated battery packs.** Use of any other battery packs may create a risk of injury and fire.
3. **Be aware of possible hazards when not using your battery tool or when changing accessories.** To reduce risk, remove the safety key and battery pack from the machine while not in operation. This will reduce the risk of electric shock, fire or serious personal injury.
4. **Do not place appliances or their batteries near fire or heat.** Continuous intense sunlight, fire or other heat sources may cause an increased danger of explosion.
5. **Do not crush, drop or damage the battery pack.** Do not use a battery pack or charger that has been dropped or received a sharp blow. A damaged battery is subject to explosion. Properly dispose of a dropped or damaged battery immediately.
6. **Batteries can explode in the presence of a source of ignition, such as a pilot light.** To reduce the risk of serious personal injury, never use any cordless product in the presence of an open flame. An exploded battery can propel debris and chemicals. If exposed, flush with water immediately.
7. **Do not charge battery in a damp or wet location.** Following this rule will reduce the risk of electric shock.
8. **Longer life and better performance can be obtained if the battery pack is charged when the air temperature is between 64 degrees F/18 degrees C and 105 degrees F/40.5 degrees C.** Do not charge the battery pack in air temperature below 41 degrees F/5 degrees C or above 105 degrees F/40.5 degrees C. This is important as it can prevent serious damage to the battery pack.
9. **Under extreme usage or temperature conditions, battery leakage may occur.** If liquid comes in contact with your skin, wash immediately with soap and

READ ALL INSTRUCTIONS BEFORE USING THIS 40V BRUSHLESS LAWN MOWER

water. If liquid gets into your eyes, flush them with clean water for at least 10 minutes, then seek immediate medical attention.

10. **When battery pack is not in use, keep it away from other metal objects like: paper clips, coins, keys, nails, screws, or other small metal objects that can make a connection from one terminal to another.** Shorting the battery terminals together may cause sparks, burns, or a fire.
11. **Do not disassemble the battery and avoid mechanical damage to the battery.** Risk of short circuit and fumes may be emitted. Ensure fresh air and seek medical assistance in the event of discomfort.
12. **Always remove battery pack from your tool when you are assembling parts, making adjustments, cleaning, or when not in use.** Removing battery pack will prevent accidental starting that could cause serious personal injury.
13. **Always remove battery pack before storing the device.** When battery becomes fully charged, unplug the charger from the power supply and remove the battery pack from the charger.
14. **Keep battery pack dry, clean, and free from oil and grease.** Always use a dry cloth when cleaning. Never use brake fluids, gasoline, petroleum-based products, or any solvents to clean battery pack.
15. **Keep the battery pack out of the reach of children.**

CHARGER SAFETY INSTRUCTIONS

1. **The plug of the charger must match the outlet.** Never modify the plug in any way. Unmodified plugs and matching outlets will reduce the risk of electric shock.
2. **Ensure the battery pack is charged indoors only, in a dry, cool and well ventilated environment.**
3. **Do not subject the battery to strong sunlight over long periods and do not leave it near a heat source.** Heat damages the battery and there is a risk of explosion.
4. **Allow a hot battery to cool before charging.**
5. **Do not use non-rechargeable batteries!**
6. **Do not attempt to charge battery packs other than those supplied.** The charger and battery pack supplied with it are specifically designed to work together.
7. **Before each use, check the charger, cable and plug.** Do not use a defective charger and do not disassemble the charger. Incorrect reassembly may result in the risk of fire, electric shock or electrocution.
8. **Protect the charger against moisture and wet conditions.** There is a danger of electric shock.
9. **Operate the charger only with the appropriate original batteries.** Charging other batteries may result in injuries and risk of fire.

SAVE THESE INSTRUCTIONS FOR REFERENCE

10. **Avoid mechanical damage to the charger.** This can result in internal short circuits.
11. **Do not operate the charger on easily inflammable surfaces (e.g. paper, textiles, etc.).** The heating of the battery charger during the charging process could pose a fire hazard.
12. **Do not abuse the cord of the charger.** Never use the cord for carrying, pulling or unplugging the charger.
13. **Keep the cord away from heat, oil, sharp edges or moving parts.** Damaged or entangled cords increase the risk of electric shock.
14. **Do not operate the charger with a damaged cord or plug, which could cause shorting and electric shock.** If damaged, immediately discontinue use. Replace the charger with the identical unit as listed in the Product Specifications in this manual. If the power cord for this equipment is damaged, it must be replaced by the manufacturer, a customer service agent of the same or qualified person in order to prevent hazards.
15. **Do not use a charger that has been dropped or received a sharp blow.**
16. The voltage indicated on the charger rating plate must correspond to the voltage of the power source.
17. Never touch the mains plug with wet hands.
18. **The battery of the appliance is not fully charged at the time of delivery.** It therefore needs to be fully recharged before you use it for the first time. For the first recharge cycle, charge the battery pack fully. Slot the battery into the base and plug the battery charger into an outlet.
19. It is good practice to unplug the charger and remove the lithium-ion battery pack when not in use.
20. This charger is not intended for use by persons (including children) with reduced physical, sensory or mental capabilities, or lack of experience and knowledge, unless they have been given supervision or instruction concerning use of the charger by a person responsible for their safety.
21. Children should be supervised to ensure that they do not play with the charger.

READ ALL INSTRUCTIONS BEFORE USING THIS 40V BRUSHLESS LAWN MOWER

RECYCLING AND DISPOSAL

⚠ WARNING! Waste electrical products should not be disposed of with household waste. Please recycle where facilities exist. Check with your local authority or local store for recycling advice.



Old products are potentially recyclable and do not, therefore, belong in your household garbage. You are requested to assist us and our contribution to saving resources and protecting the environment by handing in this product at an equipped collection centre (if there is one available).











The product comes in a package that protects it against damage during shipping. Keep the package until you are sure that all parts have been delivered and the product is function properly. Recycle the package afterwards.

⚠ WARNING! Do not dispose of batteries/rechargeable batteries into household waste!







SAFETY SYMBOLS









WARNING! Please read all of the safety and operating instructions carefully before using this tool. Please pay particular attention to all sections of this User Guide that carry warning symbols and notices. Some of the following symbols may be used on this tool.

V	Volts
A	Ampere
Hz	Hertz
W	Watts
kW	Kilowatts
L	Litres
kg	Kilograms
mA	Milliampere
mAh	Milliampere-hour
min ⁻¹	per minute
mm	Millimetre
m/s ²	Metres per second squared
	Only use the battery charger indoors.

	Direct current
 or a.c.	Alternating current
	No load speed
	Double insulation
	Diameter
	Directional arrow
	Polarity
	With fuse (xx °C)
	Lock / to tighten or secure
	Unlock / to loosen
dB(A)	Decibel (A-rated)
S	Seconds
	Recycle electrical waste products in an environmentally safe way where facilities exist.

	Warning! Danger.
	Read the operator's manual.
	WARNING! Beware of electric shocks.
	Wear hearing protection.
	Wear CSA Approved Eye Protection.
	Wear a face mask.
	Wear protective helmet and eye protection.
	Wear protective gloves.
	Wear protective footwear.
	Switch the product off and remove the battery pack to disconnect from the power supply before assembly, cleaning, adjustments, maintenance, storage and transportation.
	Do not expose the product to rain or wet conditions.
	Mow across the face of slopes, never up and down.
	Protection class II (Double insulation)

	Inspect the area where the product is to be used and remove all objects which can be thrown by the product. If objects are hidden while operating stop the product and remove the object.
	Keep hands and feet away from sharp rotating parts – danger of injury! When cleaning, repairing, or inspecting, make certain the cutting device and all mowing parts have stopped.
	Cutting device continues to rotate after the product is switched off. Wait until all machine components have completely stopped before touching the product.
 	Objects thrown by the product could hit the user or other bystanders. Always ensure that other people and pets remain at a safe distance from the product when it is in operation. In general, children must not come near the area where the product is.
	Guaranteed sound power level value in dB.

	<p>Beware of sharp blades. Blades continue to rotate after the motor is switched off - Remove disabling device before maintenance.</p>		<p>Remove plug from the power source immediately if the power cord is damaged or cut.</p>
	<p>GO – grass catcher ready for grass collection STOP - grass catcher full, empty it.</p>		<p>Batteries and battery packs should not be disposed of with household waste. Please recycle where facilities exist. Check with your Local Authority or local store for recycling advice.</p>
	<p>Batteries contain Lithium-ion. Do not dispose of batteries in household waste.</p>		<p>Do not dispose of battery packs in rivers or immerse in water.</p>
	<p>Do not dispose of battery packs in fire. They will explode or leak and cause injury.</p>		<p>Do not expose battery packs to heat in excess of 45°C.</p>
	<p>Approx. charging time</p>		



This symbol designates that this tool is listed with Canadian and U.S. requirements by cSGSus Testing Laboratories, Inc.

UL1447, CSA C22.2 No.147

GY225404

KNOW YOUR 40V BRUSHLESS LAWN MOWER

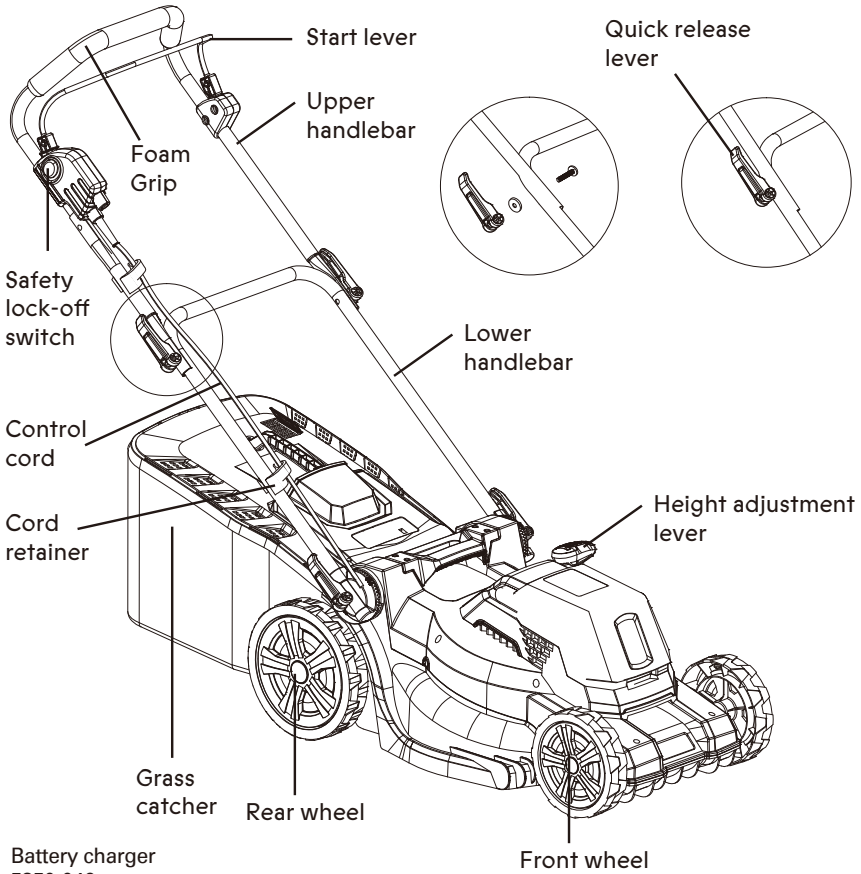

Battery charger
5350-046

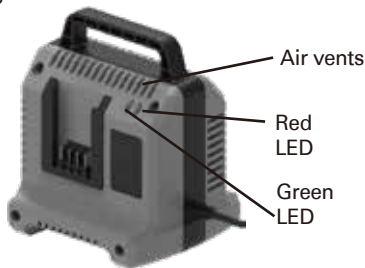

Battery
5350-014



ASSEMBLY

UNPACKING

1. Unpack all parts and lay them on a flat, stable surface.
2. Remove all packing materials if applicable.
3. Make sure the delivery contents are complete and free of any damage. If you find that parts are missing or show damage do not use the product but contact Customer Service @ 1-866-349-8665. Using an incomplete or damaged product represents a hazard to people and property.
4. Ensure that you have all the accessories and tools needed for assembly and operation. This also includes suitable personal protective equipment.



WARNING: The product must be fully assembled before operation! Do not use a product that is only partly assembled or assembled with damaged parts!



Follow the assembly instructions step-by-step and use the pictures provided as a visual guide to easily assemble the product!

Do not connect the product to battery power before it is completely assembled!

NOTE: Take care of small parts that are removed during assembly or when making adjustments. Keep them secure to avoid loss.

LOWER HANDLEBAR

1. Align the mounting hole of the lower handlebar with the bolt of handle support (Fig. 1).
2. Attach the washer to the bolt and secure the lower handlebar by turning the lever(1) up for tightening.
3. Make sure that the control cord runs up the upper side of the lower handle bar (right).

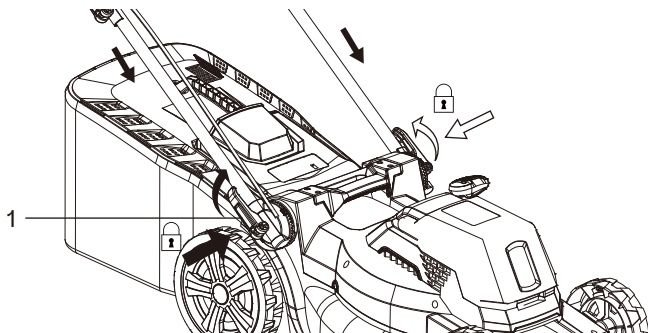

FIG.1

UPPER HANDLE BAR

1. Align the upper handlebar to the lower handlebar and ensure the foam handle is pointed up when viewed from behind.
2. Pass the bolts through the mounting holes of handles (Fig. 2).
3. Attach the washer to the bolt and secure the upper handlebar by turning the lever up for tightening (Fig.2).
4. Secure the control cord with two wire clips (Fig. 3).

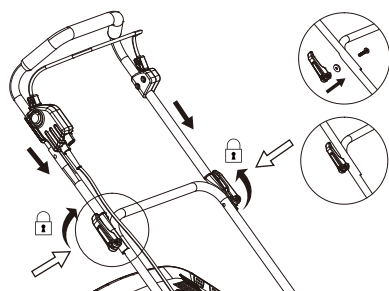

FIG.2



FIG.3

GRASS CATCHER/MULCHING OPTION

1. Align and insert the carry handle into the slots of top frame of grass catcher until both ends "click" into place (Fig. 4). then use screw to fix handle both sides.
2. The grass catcher is ready for use.
3. If you choose the mulcher function, then ensure the plate is inserted over the grass chute, Do not install the grass catcher. Remove plate to use the grass catcher.



WARNING: Do not attempt to use the product unless you have either the grass catcher attached, or if mulching, the mulching plate installed.



Danger of flying objects! The motor must be switched off and the blade must have stopped rotating before you remove the grass catcher. The grass catcher must be fully assembled with the top part, bottom part and collection tongue all in position before first use.

4. Open the deflector guard, hold it in position ; Insert the grass catcher (Fig.5).
5. Align and hook the grass catcher into the attachment slots of rear discharge chute.

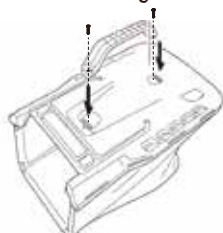

FIG.4

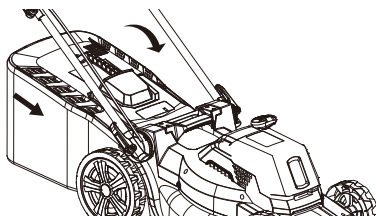

FIG.5

CHECKING THE BATTERY CHARGE STATUS

The level of charge remaining in the battery can be checked by using the battery LED power indicator that is contained on the end of the battery.

NOTE: The battery charge remaining may be checked while the battery is installed in the tool with the ON/OFF switch turned OFF. It may also be checked while the battery is removed from the tool. DO NOT check the battery charge remaining while the battery is in the charger.

You will get a false reading and you may also damage the battery status system.

1. Press and hold the battery status button located on the end of the battery
2. One or more of the three LED lights in the LED window will come ON to indicate the amount of charge that is remaining in the battery as follows:

1 light (Red light ON)	2 lights (Red and Orange light ON)	3 lights (Red/Orange/Green ON)
1/3 or less	1/3 - 2/3	2/3 - Fully charged



FIG.6

3. Release the battery status button to turn the LED's OFF.

CHARGING THE BATTERY PACK



WARNING: Charge in a safe location away from moisture and heat sources!

1. Place the battery charger in a dry location near a 110-120V 60 Hz electrical outlet (Fig. 7).
2. Plug the battery charger into the outlet and make sure the green LED indicator light comes ON. If it does not, refer to the chart (Fig. 8) to identify the problem.
3. Turn the battery pack upside down and slide it onto the charger .

NOTE: Make sure the grooves in the sides of the battery slide over the matching tabs on the charger until the battery latch "clicks" into place.



Fig. 7

Green Light	Red Light	Battery Inserted Into Charger	Charging Status
ON	OFF	NO	Charger connected to power supply.
OFF	ON	YES	Battery being charged.
ON	OFF	YES	Battery fully charged.
ON	OFF	YES	Battery is charged but not operational on tool. This may indicate defective / bad contact on battery or charging conditions are either too hot or too cold.

Fig. 8

OPERATION

INSTALLING THE BATTERY PACKS

1. Open the battery compartment cover .
2. Unplug the safety key(1) (Fig.9).
3. Remove the discharged battery packs by pressing downward on the battery release button and sliding the battery pack backward until it is removed from the battery compartment (Fig. 9).
4. Slide the fully charged battery packs onto the matching tabs in the battery compartment where the discharged battery packs have been removed.
5. Reinstall the safety key .
6. Close the battery compartment cover.

WARNING: Make sure the grooves in the sides of the battery slide over the matching tabs of the battery compartment. The battery release button will “click” into place when the battery is fully installed.



WARNING: Do not immerse the battery pack in water. Sudden cooling could cause a hot battery to explode or leak.

NOTE: Mower will only operate when both batteries are charged and installed.

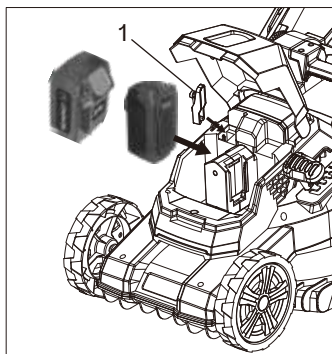

Fig. 9

CUTTING HEIGHT ADJUSTMENT



WARNING: Switch the product off and wait until the blade has come to a complete stop before adjusting the cutting height!

Remove the safety key before adjusting the cutting height!



Adjust the cutting height according to the needs of your lawn. The cutting height depends on the kind of lawn and its actual height. When mowing high grass, start with the maximum cutting height and make a second cut with a lower cutting height.

1. Press the lever towards the rear wheel (Fig. 10).
2. Move forward or backward to adjust the cutting height.
3. Release the lever and ensure it is engaged in the slot properly.



WARNING: Ensure that the lever engages in the slot after each adjustment.

NOTE: There are 6 cutting height levels available. The adjustable heights are 1" (25mm) to 3" (75mm).

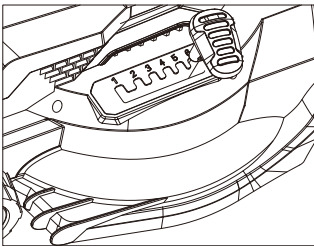

FIG.10



FIG.11

GRASS CATCHER



WARNING: Do not attempt to use the product without the grass catcher attached when collecting grass – danger of flying objects!

Switch the motor off and wait that the blade had come to a complete stop before removing the grass catcher!



Always carry the grass catcher by its carry handle.

INDICATOR

The grass catcher is equipped with a full bag indicator that indicates the filling progress during operation.

1. When the hatch is open the grass catcher has sufficient volume left to collect grass (Fig. 11).
2. When the hatch is closed, the grass catcher is full and must be emptied (Fig. 11).

EMPTYING THE GRASS CATCHER

Empty the grass catcher frequently during use. Do not wait until it is completely full. We recommend emptying it when it is half full.

NOTE: A full grass catcher will reduce the performance of this product.

1. Release the start lever ensuring that the motor has stopped and the blade has stopped rotating.
2. Lift the deflector guard and lift the grass catcher off the hooks.
3. Remove the grass clippings from the rear discharge chute into the grass catcher. Use a proper tool such as a brush.
4. Remove the grass catcher by its carry handle .
5. Empty the grass clippings onto a compost heap.
6. Re-fit the grass catcher to the product.



WARNING: Never use your hands or feet to remove grass clippings from the rear discharge chute !

GENERAL OPERATION

1. Check the product, its battery pack and charger as well as accessories for damage before each use. Do not use the product if it is damaged or shows wear.
2. Double check that accessories and blade are properly fixed.
3. Check the battery status. Recharge if necessary.
4. Always push the product by its handle. Keep the handle dry and free from lubricant to ensure safe support.
5. Switch the product off immediately if you are disturbed while working by other people entering the working area. Always let the product come to complete stop before leaving it unattended.
6. Do not overwork yourself. Take regular breaks to ensure you can concentrate on the work and have full control over the product.



WARNING: In some countries regulations define at what time of the day and on what special days products are allowed to be used and what restrictions apply! Ask your community for detailed information and observe the regulations in order to preserve a peaceful neighbourhood and avoid committing administrative offences!

STARTING/STOPPING

1. Insert batteries.
2. Plug the safety key into the slot fully.
3. Stand behind the grip handle .
4. While holding the safety lock-off switch pressed, pull the start lever towards the handle.
5. After the mower starts, release the safety lock-off switch.
6. Release the start lever to stop the mower.

MOWING

1. Make sure that the lawn is clear of stones, sticks, wire or other objects that could damage the product or its product.
2. Do not cut wet grass because it tends to stick to the underbody of the mower, preventing the proper discharge of grass clippings, and it could also cause you to slip and fall.
3. Never cut off more than one-third of the total length of the grass for a healthy lawn. In the autumn, lawns should only be cut as long as there is growth.
4. Slowly push the mower forward.
5. Mow in slight overlapping rows. The most effective pattern for mowing lawns is straight lines along one of the sides. This will keep the rows even and ensures that all the lawn is cut without missing any spots.
6. Circle around flower beds. When reaching a flower bed in the middle of the lawn, cut a row or two around the circumference of the bed.
7. Pay special attention when changing direction.
8. Empty the grass catcher regularly.

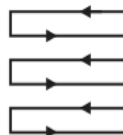

WARNING: If the mower strikes a foreign object stop immediately! Let the product cool down and thoroughly inspect the product for damage! Have any damage repaired before restarting!



AFTER USE

1. Switch the mower off, disconnect the safety key, remove the battery packs and let them cool down.
2. Check, clean and store as described on the following pages.

MAINTENANCE



WARNING: Always switch the mower off, remove the battery packs and the safety key and let the mower cool down before performing inspection, maintenance and cleaning work!



1. Keep the mower clean. Remove debris after each use and before storage.
2. Regular and proper cleaning will help ensure safe use and prolong the life of the product.
3. Inspect the mower before each use for worn and damaged parts. Do not operate it if you find broken and worn parts.



WARNING: Only perform repairs and maintenance work according to these instructions! All further works must be performed by a qualified specialist!

GENERAL CLEANING

1. Clean the mower with a dry cloth. Use a brush for areas that are hard to reach.
2. Remove stubborn dust with high pressure air (43 PSI).

NOTE: Only perform repairs and maintenance work according to these instructions! All further works must be performed by a qualified specialist!

3. Check for any damage and wear. Repair damages in accordance with this instruction manual or take it to an authorised service centre before using the product again.

GENERAL CLEANING



WARNING: Wear safety gloves when working on the blade and close to it! Use proper tools to remove debris, e. g. a wooden stick! Never use your bare hands!



Always use original spare parts for replacement. Do not attach any other type of blade! The replacement of the blade should be done by a qualified specialist!

1. Keep the underbody and blade clean and free of debris. Remove clippings from the rear discharge chute .
2. Check all fasteners, such as nuts and bolts, periodically for tightness before operation. After prolonged use, especially in sandy soil conditions, the blade will become worn and lose some of the original shape. The cutting efficiency will be reduced and the blade should be replaced.

3. Keep the blade sharp to ensure a good cutting performance. Replace a worn or damaged blade with a new one of the same type or have it sharpened by a qualified specialist.
4. Loosen the hex bolt counterclockwise using the supplied hex wrench and remove it together with the washer and the blade (Fig. 12).
5. Replace the blade with a new one of the same type. Check the status of the flange onto the blade holder, then attach the blade properly, and fix it with the washer and the hex bolt. Tighten the hex bolt clockwise. Replace with 33-44 ft/lbs to ensure safe operation of your product.



DANGER: If the blade is not torqued properly, they could become loose and be thrown from the product and seriously hurt or kill the operator or bystanders.

Note: Replace this blade after 50 hours mowing or 2 years whichever is sooner regardless of condition. If the blade is cracked or damaged, you must immediately replace it with a new one.

6. Lubricate the blade after each use to prolong the lifespan of blade and product. Apply light machine oil along the edge of the blade.

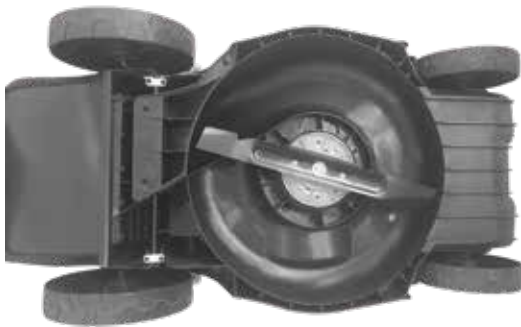

FIG.12

GRASS CATCHER

1. Inspect the grass catcher before each use. Do not use it if you find any damage.
2. Clean the grass catcher after operation using water and mild soap.
3. Let the grass catcher dry thoroughly before storing to avoid mildew.

CHARGER

If the power cord of the charger is damaged, it must be replaced by the manufacturer, its service agent or similarly qualified persons in order to avoid a safety hazard.

STORAGE

1. Remove batteries from mower.
2. Clean the product as described above.
3. Store the product and its accessories in a dry, frost-free place.
4. Always store the product in a place that is inaccessible to children. The ideal storage temperature is between 50°F/10°C & 86° F/30° C.
We recommend using the original package for storage or covering the
5. product with a suitable cloth or enclosure to protect it against dust.

TRANSPORTATION

1. Switch the mower off, disconnect the safety key and remove the batteries before transporting it anywhere.
2. Always transport the mower by its transport handle .
3. Protect the mower from any heavy impact or strong vibrations which may occur during transportation in vehicles.
4. Secure the mower to prevent it from slipping or falling over, damage and injury.

EXPLODED VIEW

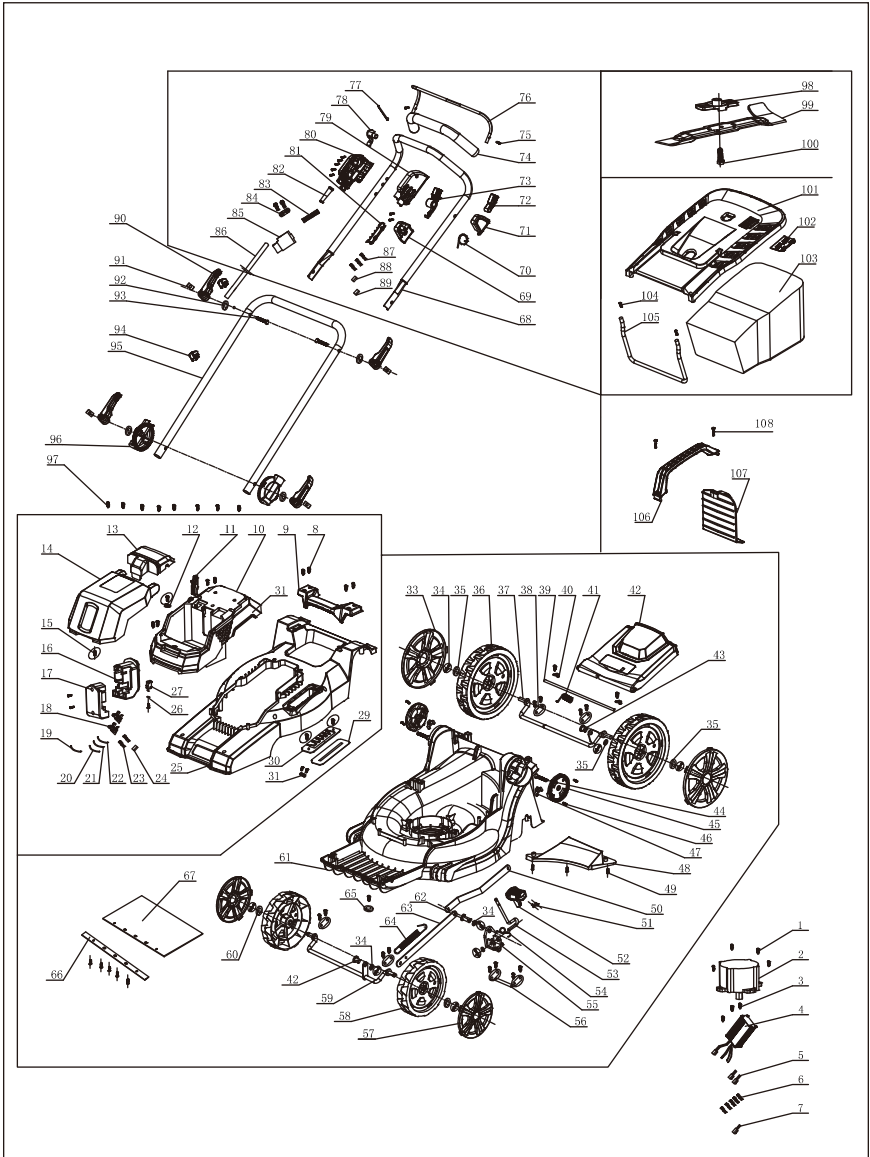

PARTS LIST

⚠ WARNING: When servicing, use only original equipment replacement parts. The use of any other parts may create a safety hazard or cause damage to the brushless lawn mower.

Any attempt to repair or replace electrical parts on this brushless lawn mower may create a safety hazard unless repairs are performed by a qualified technician. For more information, call the Toll-free Helpline, at 1-866-349-8665 – Monday to Friday from 9am to 5pm Eastern Standard Time.

Always order by key number.

Key #	Part #	Part Name	Quantity
MOTOR ASSEMBLY			
1	33SBAQA006200101	Screw	4
2	3422540101004001	Brushless motor	1
3	33SBAQA004160101	Screw	3
4	3422540601092001	Controller	1
5	36040101	Double hole male terminal sleeve	2
6	36010108	Female terminal	5
7	36040103	Single hole male terminal sleeve	1
MACHINE ASSEMBLY - UPPER HOUSING ASSEMBLY			
8	33SBAQA004160101	Screw	16
9	3122530101094001	Handle	1
10	3122540101069001	Cover	1
11	3122520101056001	Safety key	1
12	3222540101010001	Magnet	1
13	3122540101053001	Plate	1
14	3122540201069001	Transparent cover	1
15	33SEADA004120101	Sunk screw	4
16	3100810201039001	Battery pack upper bracket	1
17	3100810101039001	Battery pack under bracket	1
18	3118920101049001	Inserting seat	2
19	3417820101027001	Internal wiring1	1
20	3418830301027001	Internal wiring3	1
21	3419510501027001	Internal wiring5	1
22	3422910101027001	Carbon brush line1	1
23	36040102	Double hole bushing	1
24	36010109	Male terminal	2
25	3152200101142001	Front cover	1
26	3392000101030001	Washer	1
27	3422710101032001	Microswitch	1
29	3152200201030001	Washer	1

Key #	Part #	Part Name	Quantity
30	3252200101053001	Height setting gauge	1
31	3181000101053001	Clamping plate	1
MACHINE ASSEMBLY - CHASSIS COMPONENTS			
33	3152200301069001	9"Wheel cover	2
34	3322530101138001	Cotter pin	8
35	3360000201030001	Washer	5
36	3152200101031001	9"Wheel	2
37	3252200101020001	Rear axle shaft	1
38	3252200201053001	Axle clamping plate	6
39	3252200201020001	Back cover shaft	1
40	3252200301053001	L clamp	2
41	3252200301060001	Back cover button spring	1
42	3152200201069001	Back cover	1
43	3252200201103001	Connecting rod buckle-2	2
44	3252200201074001	Square head bolt	2
45	3152000201072001	Adjusting slider-inside	2
46	33SBAQA005200101	Screw	4
47	3252200401053001	Handrail retaining plate	2
48	3152200401053001	Baseplate	1
49	33SBAQA004160101	Screw	26
50	3252200401057001	Back link	1
51	33SJCOC005080101	Large flat head screw	2
52	3155000101094001	Height adjusting handle	1
53	3252200501057001	Adjustment lever	1
54	3252200401060001	Adjust lever knob spring	1
55	3152200101049001	Adjust lever block	1
56	3252200301020001	Adjusting rod shaft	1
57	3122530201069001	Rear wheel cover	2
58	3122530201031001	Rear wheel	2
59	3252200401020001	Front axle	1
60	3322530201030001	Washer	3
61	3152200101139001	Chassis	1
62	3252200101103001	Connecting rod buckle-1	1
63	3252200301057001	Front link	1
64	3252200501060001	High tension spring	1
65	3390000401030001	Washer	1
66	3252200101150001	Straw baling	1
67	3252200501153001	Grass baffle plate	1
MACHINE ASSEMBLY - STEEL WIRE HANDLE ASSEMBLY			
68	3222540101057001	Upper push rod	1
69	3150000201049001	Tie rod fixed seat 1	1
70	3250000401060001	Reed switch knob	1

Key #	Part #	Part Name	Quantity
71	3150000301049001	Tie rod fixed seat 2	1
72	3150000401049001	Switch board seat 2	1
73	3150000201157003	Switch board seat 2	1
74	3150000501023001	Handle cover	1
75	33SBAQA004160101	Screw	12
76	3222540201057001	Switch lever	1
77	3250000201030001	Switch spring	1
78	3150000201058001	Switch unlock button	1
79	3150000101069001	Switch box left cover	1
80	3150000201069001	Switch box right cover	1
81	3150000601053001	Switch box fixing plate	1
82	3150000401023001	Cable sheath	1
83	3250000301060001	Unlock button spring	1
84	3181000101053001	Cable clamp	1
85	3450000101032001	Switch	1
86	3422540301027001	Cable	1
87	36040102	Double hole bushing	1
88	36010109	Male terminal	3
89	36040104	Single hole socket sleeve	1
PART PACKED - PUSH ROD ASSEMBLY			
90	3152200101098001	Quick release lever	4
91	3252200101138001	Screw pin	4
92	3352200301030001	Washer	4
93	3252200101074001	Square head bolt	2
94	3150000201103001	Line buckle	2
95	3252200201057001	Down push rod	1
96	3152200301072001	Adjusting slider-outside	2
97	33SBAQA004160101	Screw	8
PART PACKED - BLADE ASSEMBLY			
98	3222540101049001	Blade holder	1
99	3252200101132001	Blade	1
100	33SNDQC010250101	Hex flange non-slip bolt	1
PART PACKED - GRASS BOX COMPONENT			
101	3152200401069001	Catcher handle	1
102	3122530701069001	Louver cover	1
103	355220201045001	Catcher bag	1
104	33SBAQD004150101	Triple screw	2
105	3252200101039001	Grass framework	1
ACCESSORIES			
106	3122530201094001	Grass shute cover plate handle	1
107	3152200401072001	Grass shute cover plate	1
108	33SBAQA004160101	Screw	2

WARRANTY

RADLEY 40V BRUSHLESS LAWN MOWER WARRANTY

If this Radley tool fails due to a defect in material or workmanship within three years from the date of purchase, return it to any Home Hardware store with the original bill of sale for exchange. Two years for battery and charger. This warranty does not include expendable parts including but not limited to blades, brushes, belts, and light bulbs. This warranty covers defects in material or workmanship only. It does not cover normal wear and tear, failure due to abuse/misuse, or defects caused by careless or accidental mishandling. If this Radley product is used for commercial or rental purposes, this warranty does not apply. For use at the consumer level. The warranty is not for industrial or commercial applications.

40V Max*

Lawn Mower

Owner's
Manual

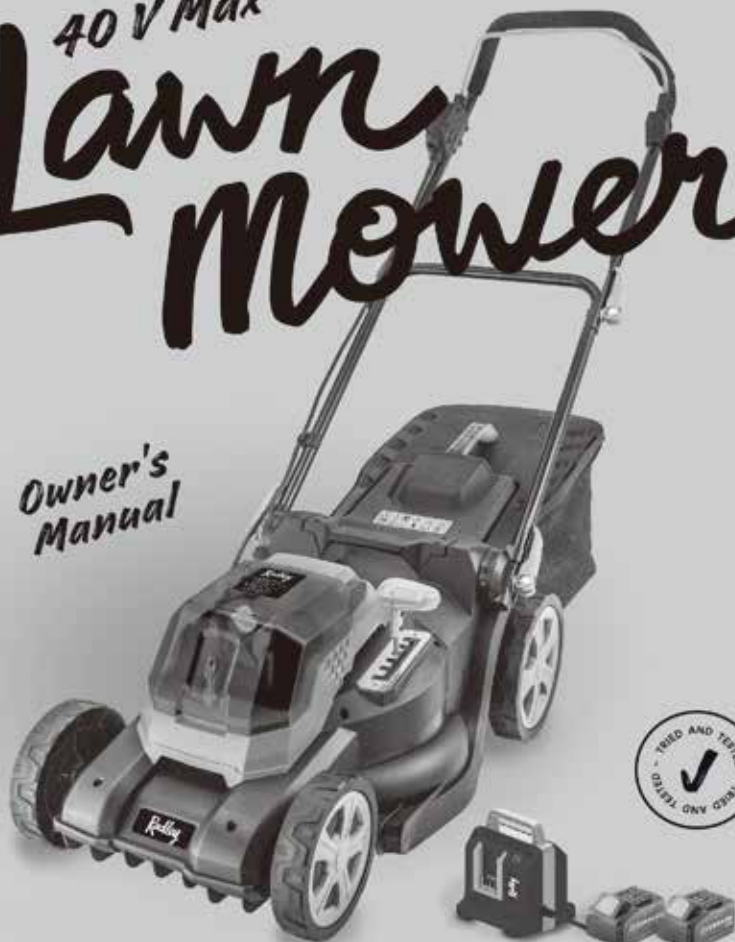

20V + 20V = 40V

5125-018

Radley®



EXCLUSIVE TO HOME HARDWARE

For information on the entire line up of Radley power tools visit homehardware.ca or your local Home Hardware retail store.

MADE IN CHINA / FABRIQUÉ EN CHINE
HOME HARDWARE STORES LIMITED
ST. JACOBS, ONTARIO N5B 2N0
ORDER ONLINE / COMMANDE EN LIGNE
homehardware.ca

© 12 / 2020 Home Hardware Stores Limited

If this Radley tool fails due to a defect in material or workmanship within three years from the date of purchase, return it to any Home Hardware store with the original bill of sale for exchange. Battery and charger is a limited two year warranty.