

Radley®

INVERTER STICK WELDER KIT OWNER'S MANUAL



3 Year Limited Warranty on tool



**READ ALL INSTRUCTIONS BEFORE FIRST USE.
KEEP THIS MANUAL FOR FUTURE REFERENCE.
KEEP AWAY FROM CHILDREN.**



**WEAR CSA APPROVED
EYE PROTECTION**



**WEAR EAR
PROTECTION**



**WEAR FACE
PROTECTION**

PRODUCT SPECIFICATIONS

PRODUCT NAME	1150-000
Input Voltage	1ph 120V
Input Power (KVA)	2.4
Input Current (A)	20
Output Current Range (A)	20-75A
Max. Output Current (A)	75A/23V
No-load Voltage (V)	70
Rated Duty Cycle	40% at 75A
Efficiency (%)	85
Power Factor	0.65
Protection Class	IP21S
Insulation Class	H
Tool Dimensions	12 3/8" x 4 x 6 15/16" (31.5 x 10.2 x 17.6cm)
Net Weight	6.61lb/3kg
Input Power Cord Length	2m/6.5ft
Welding Cable Length	1.5m/4.9ft
Earth Clamp Length	1.5m/4.9ft

NEED ASSISTANCE?

Call us on our toll free customer support line:

1-866-349-8665 (Monday through Friday 9am - 5pm Eastern Time)

- Technical questions
- Replacement parts
- Parts missing from package

TABLE OF CONTENTS

Product Specifications 1
Table of Contents 2
General Safety Warnings 3
Specific Safety Warnings for Welders 7
Safety Symbols 9
Know Your Radley Stick Welder 10
Assembly 11
Operation 12
Troubleshooting 16
Exploded View 17
Parts List 18
Warranty 18

GENERAL SAFETY WARNINGS









IMPORTANT SAFETY INSTRUCTIONS

Read and understand all safety and operational instructions. Failure to follow the safety rules listed below and other basic safety precautions may result in serious personal injury. Keep this manual, sales receipts and applicable warranty forms for future reference.

SAFETY SYMBOLS

The purpose of safety symbols is to alert you of the potential safety RISKS. Recognize and understand them. Follow the instructions provided.

SYMBOL	MEANING
	Failure to obey a DANGER safety alert WILL result in serious personal injury or death to you or to others. Always obey all messages following this symbol to reduce the risk of serious personal injury or death.
	Failure to obey a WARNING safety alert MAY result in serious personal injury or death to you or to others. Always obey all messages following this symbol to reduce the risk of potential serious personal injury or death.
	Failure to obey a CAUTION safety alert MAY result in personal injury or property damage to you or to others. Always obey all messages following this symbol to reduce the risk of personal injury or property damage.
 	Failure to obey a NOTICE or a CAUTION (without a safety alert) MAY result in property damage to you or to others. Always obey all messages following this symbol to reduce the risk of property damage.
 	ALWAYS WEAR EYE PROTECTION THAT CONFORMS WITH CSA Z94.3 or ANSI SAFETY STANDARD Z87.1 FLYING DEBRIS can cause permanent eye damage. Prescription eyeglasses ARE NOT a replacement for proper eye protection. The usage of a safety standard compliant face shield placed over proper safety glasses or goggles can reduce the risk of facial injury. Non-compliant eyewear can cause serious injury if broken during the operation of a power tool.
 	Use hearing protection, particularly during extended periods of operation of the tool, or if the operation is noisy.
 	WEAR A DUST MASK THAT IS DESIGNED TO BE USED WHEN OPERATING A POWER TOOL IN A DUSTY ENVIRONMENT.

SYMBOL	MEANING
<p>⚠ WARNING</p> 	<p>Always wear non-slip gloves that fit properly to protect your hands and to help you grip the tool.</p> <p>Always wear sturdy clothing with long sleeves and long pants. Never operate the tool while wearing shorts, short sleeve shirt or while shirtless.</p> <p>Always wear non-slip safety boots to prevent foot injuries and slipping that could cause loss of control of the tool.</p>
<p>⚠ WARNING</p> 	<p>To avoid electrical hazards, fire hazards or damage to the tool, use proper circuit protection.</p> <p>This machine is wired at the factory for 120V AC operations (Plug will only fit one way). Plug the power cord into a properly grounded, GFCI protected 120V AC receptacle that matches the plug. The circuit must be equipped with delayed action-type circuit breaker or fuses. To avoid shock or fire, replace power cord immediately if it is worn, cut or damaged in any way.</p>
<p>⚠ WARNING</p> 	<p>WARNING: Ventilation openings in batteries and chargers must always be open to allow cooling air to circulate freely. Air vents that are blocked, restricted or covered may result in the battery or charger overheating. Overheating may lead to damage to the tool or cause a fire, resulting in possible serious injury.</p>
	<p>ELECTRIC SHOCK CAN KILL</p>
	<p>FUMES AND GASES</p>
	<p>FIRE HAZARDS</p>
	<p>ARC RAYS</p>
	<p>HOT MATERIALS</p>
	<p>MAGNETIC FIELDS</p>

⚠️ WARNING:

OWNER'S MANUAL. Read and understand this owner's manual BEFORE using machine.

TRAINED OPERATORS ONLY. Untrained operators have a higher risk of being hurt or killed. Only allow trained/supervised people to use this welder. When welder is not being used, disconnect power, remove switch keys, or lock-out to prevent unauthorized use—especially around children. Make your workshop kid proof!

DANGEROUS ENVIRONMENTS. Do not use machinery in areas that are wet, cluttered, or have poor lighting. Operating machinery in these areas greatly increases the risk of accidents and injury.

MENTAL ALERTNESS REQUIRED. Full mental alertness is required for safe operation of machinery. Never operate under the influence of drugs or alcohol, when tired, or when distracted.

ELECTRICAL EQUIPMENT INJURY RISKS. You can be shocked, burned, or killed by touching live electrical components or improperly grounded machinery. To reduce this risk, only allow qualified service personnel to do electrical installation or repair work, and always disconnect power before accessing or exposing electrical equipment.

DISCONNECT POWER FIRST. Always disconnect machine from power supply before making adjustments, changing tooling, or servicing machine. This prevents an injury risk from unintended startup or contact with live electrical components.

EYE PROTECTION. Always wear ANSI-approved safety glasses or a face shield when operating or observing machinery to reduce the risk of eye injury or blindness from flying particles. Everyday eyeglasses are NOT approved safety glasses.

WEARING PROPER APPAREL. Do not wear clothing, apparel or jewelry that can become entangled in moving parts. Always tie back or cover long hair. Wear non-slip footwear to reduce risk of slipping and losing control or accidentally contacting cutting tool or moving parts.

HAZARDOUS DUST. Dust created by machinery operations may cause cancer, birth defects, or long-term respiratory damage. Be aware of dust hazards associated with each workpiece material. Always wear a NIOSH-approved respirator to reduce your risk.

HEARING PROTECTION. Always wear hearing protection when operating or observing loud machinery. Extended exposure to this noise without hearing protection can cause permanent hearing loss.

REMOVE ADJUSTING TOOLS. Tools left on machinery can become dangerous projectiles upon startup. Never leave chuck keys, wrenches, or any other tools on machine. Always verify removal before starting!

USE CORRECT TOOL FOR THE JOB. Only use this tool for its intended purpose - do not force it or an attachment to do a job for which it was not designed. Never make unapproved modifications—modifying tool or using it differently than intended may result in malfunction or mechanical failure that can lead to personal injury or death!

AWKWARD POSITIONS. Keep proper footing and balance at all times when operating machine. Do not overreach! Avoid awkward hand positions that make workpiece control difficult or increase the risk of accidental injury.

CHILDREN & BYSTANDERS. Keep children and bystanders at a safe distance from the work area. Stop using machine if they become a distraction.

GUARDS & COVERS. Guards and covers reduce accidental contact with moving parts or flying debris. Make sure they are properly installed, undamaged, and working correctly before operating machine.

FORCING MACHINERY. Do not force machine. It will do the job safer and better at the rate for which it was designed.

NEVER STAND ON MACHINE. Serious injury may occur if machine is tipped or if the cutting tool is unintentionally contacted.

STABLE MACHINE. Unexpected movement during operation greatly increases risk of injury or loss of control. Before starting, verify machine is stable and mobile base (if used) is locked.

USE RECOMMENDED ACCESSORIES. Consult this owner's manual or the manufacturer for recommended accessories. Using improper accessories will increase the risk of serious injury.

UNATTENDED OPERATION. To reduce the risk of accidental injury, turn machine OFF and ensure all moving parts completely stop before walking away. Never leave machine running while unattended.

MAINTAIN WITH CARE. Follow all maintenance instructions and lubrication schedules to keep machine in good working condition. A machine that is improperly maintained could malfunction, leading to serious personal injury or death.

DAMAGED PARTS. Regularly inspect machine for damaged, loose, or misaligned parts - or any condition that could affect safe operation. Immediately repair/replace before operating machine. For your own safety, DO NOT operate machine with damaged parts!

MAINTAIN POWER CORDS. When disconnecting cord-connected machines from power, grab and pull the plug—NOT the cord. Pulling the cord may damage the wires inside. Do not handle cord/plug with wet hands. Avoid cord damage by keeping it away from heated surfaces, high traffic areas, harsh chemicals, and wet/damp locations.

SERVICE

- Have your machinery serviced by a qualified repair person using only identical replacement parts. This will ensure that the safety of the machinery is maintained.

SPECIFIC SAFETY WARNINGS FOR WELDERS

⚠️ WARNING:

In order to avoid mistakes that could cause serious injury, read the following steps carefully and understand them thoroughly before using this welder.

WELDING FUMES. Breathing welding fumes can cause suffocation or poisoning without warning. Keep your head out of welding fumes. Use adequate ventilation at the arc to safely remove the fumes from your breathing zone and the general area. Use ANSI approved respirators for the type of welding operation. Protect others from these fumes.

WELDING IN A CONFINED SPACE CAN BE HAZARDOUS. Always open all covers, sustain forced ventilation, remove toxic and hazardous materials, and provide a power disconnect to the welder inside the workspace. Always work with someone who can give you help from outside the space. Welding can displace oxygen. Always check for safe breathing atmosphere and provide air-supplied respirators if necessary. Keep in mind that all normal welding hazards are intensified in a confined space.

ELECTRIC SHOCK. DO NOT touch live electrical parts. Connect welder to power source with approved earth ground. Make sure all electrical connections are tight, clean, and dry. Connect workpiece to approved earth ground. The work lead is NOT a ground connection and is to be used only to complete the working welding circuit. Do not operate the welder if the output cable, electrode, or any part of the system is wet. Do not immerse them in water. Do not allow any body part to come in contact with the electrode if you are in contact with the material being welded, ground or electrode from another welder.

PREVENT FIRES. Welding work zones must be kept clear of flammable liquids, such as gasoline and solvents; combustible solids, such as paper and wood; and flammable gases, such as acetylene and hydrogen. Provide approved fire barriers and fire extinguishing equipment for the welding zone. Stay alert for sparks and spatter thrown into cracks and crevices that can start a smoldering fire. Inspect the work area again one hour after welding for any potential fire hazards.

WORKING AREA. Keep working area clear of any material not involved in the welding operation. Keep all equipment, workpieces, and work surfaces clean, dry, and free of entanglements. Keep lead cables organized and away from your body.

PROTECT BODY FROM ARC BURNS, SPARKS, AND SPATTER. Wear correct and approved eye, ear, and body protection. Wear complete body protection, such as clean and oil-free protective clothing, leather gloves, protective cap, heavy long-sleeve shirt, cuffless pants, and high leather boots. DO NOT wear jewelry or frayed clothing. Use a welding helmet with the correct shade of filter for the operation. Protect other people and property in your working zone from exposure to arc radiation, sparks, and spatter.

HANDLING GAS CYLINDERS. Regardless of content, pressurized gas cylinders can explode. Always secure a protector cap in place over the outlet valve assembly when moving the cylinder.

A broken off valve could release the pressurized contents and cause the cylinder to be hurled about at dangerously high speeds, causing serious property damage, personal injury, or death. Always use safe methods when moving gas cylinders. Always secure a gas cylinder to a wall or approved cylinder cart with a chain before using or storing.

PROTECT GAS CYLINDERS FROM HEAT OR DAMAGE. An excess of heat can cause the pressurized gas to expand and explode the cylinder. Never weld on the gas cylinder. Damaging the outside of the cylinder can cause the cylinder to crack and explode. Exploding pressurized gas cylinders can cause serious property damage, personal injury, or death.

ELECTRIC AND MAGNETIC FIELDS (EMF). Welding operations create EMF around the welding equipment and workpieces. Workers who have pacemakers must consult with their physician before using this equipment or being within 50 feet of welding operations.











EXPERIENCING DIFFICULTIES. If you are experiencing difficulties performing the intended operation, stop using the equipment. Wear a full-coverage helmet with shade (see ANSI Z87.1 safety standard) and safety glasses while welding. Wear proper gloves and protective clothing to prevent your skin from being exposed to hot metals, UV and IR rays.

Do not touch the electrode and the ground or grounded work piece at the same time. Do not use a welder to thaw frozen pipes.

SAVE THIS USER MANUAL**WARNING:**

MISUSE or failure to follow the safety rules stated in this instruction manual may cause serious personal injury.

SAFETY SYMBOLS

	WARNING: Please read all of the safety and operating instructions carefully before using this tool. Please pay particular attention to all sections of this User Guide that carry warning symbols and notices. Some of the following symbols may be used on this tool.
	Observe caution and safety notes.
	To reduce the risk of injury, user must read and understand User Guide before using this tool.
	Wear ear protection.
	Wear protective helmet and eye protection.
	Switch off and remove plug from power source before cleaning or maintenance.
	Do not use in the rain or leave outdoors while it is raining.
	Keep bystanders away.
	Don't touch the inlet and outlet when the vacuum cover is opened or the tube is removed.
	Double insulation.
	Remove plug from the power source immediately if the power cord is damaged or cut.

KNOW YOUR BENCHMARK FLUX CORE WELDER

Attention

Always be sure that the machinery is switched off and unplugged before adjusting or checking function on the machinery.

FUNCTIONS

- | | |
|---------------------------------------|---------------------------|
| 1. Power | 2. Alarm |
| 3. Current adjustment | 4. Ground cable and clamp |
| 5. Welding cable and electrode holder | 6. Input power |
| 7. ON/OFF switch | |

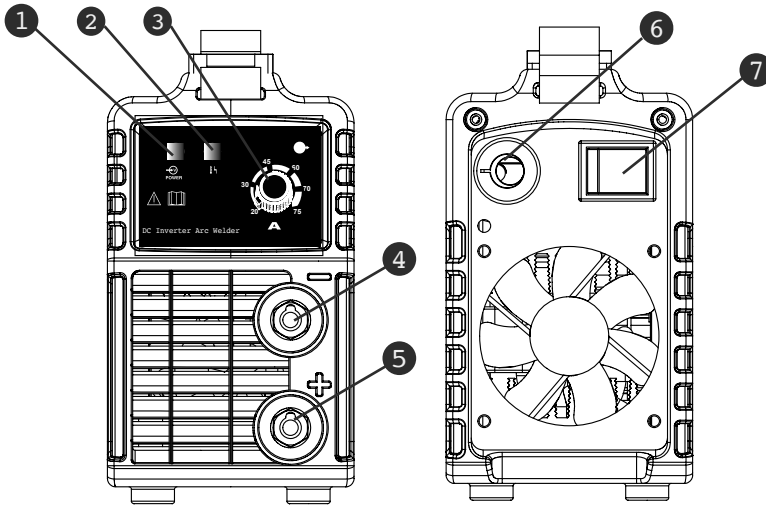

ASSEMBLY

1. Connect the welding cable and ground cable as shown below: welding cable connected to anode and ground cable connected to cathode.

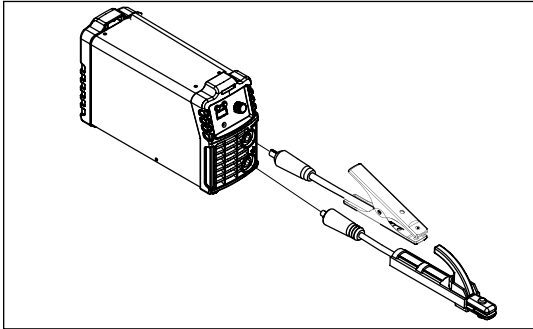

2. Instructions for carry strap installation:

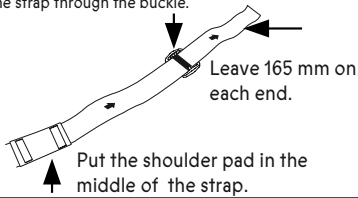
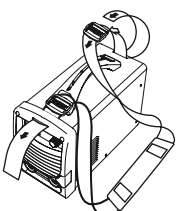
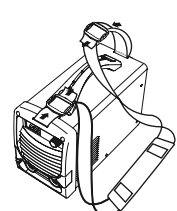
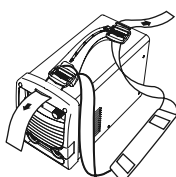
<p>step 1 Get the strap through the buckle.</p>  <p>Leave 165 mm on each end.</p> <p>Put the shoulder pad in the middle of the strap.</p>	<p>step 3 Pull the two ends through the buckle.</p> 	<p>step 4 Pull the strap tight until it becomes locked by the buckle.</p> 
<p>step 2 Install the strap onto the machine.</p> 		

OPERATION

ELECTRODE SELECTION

The welding electrode is a rod coated with a layer of flux. When welding, electrical current flows between the electrode (rod) and the grounded metal workpiece. The intense heat of the arc between the rod and the grounded metal melts the electrode and the flux. The most popular electrodes are:

- E6013 60,000 PSI tensile strength used for poor fit-up applications.
- E7018 70,000 PSI tensile strength

This welder is capable of welding with 1/16" (1.6 mm), and 5/64" (2 mm) and 3/32" (2.4 mm) electrodes.

WELDING POSITION

There are two basic positions for welding: flat and horizontal. Flat welding is generally easier, faster, and allows for better penetration. If possible, the workpiece should be positioned so that the bead will run on a flat surface.

PREPARING THE JOINT

Before welding, the surface of the workpiece must be free of dirt, rust, scale, oil or paint, which create a brittle and porous weld. If the base metal pieces to be joined are thick or heavy, it may be necessary to bevel the edges with a metal grinder. The correct bevel should be around 60 degrees. See following picture:

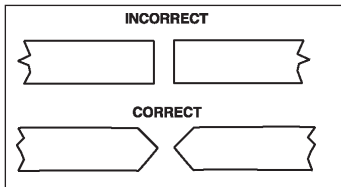

Based on different welding positions, there are different welding joints; see following images for more information:

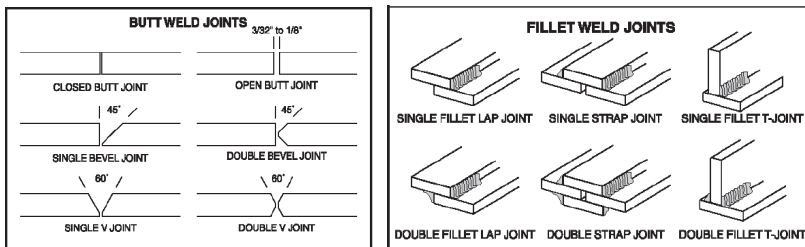

GROUND CLAMP CONNECTION

Clear any dirt, rust, scale, oil or paint on the ground clamp. Make certain you have a good solid ground connection. A poor connection at the ground clamp will waste power and heat. Make sure the ground clamp touches the metal.

SELECTING THE PROPER ELECTRODE

There is no golden rule that determines the exact rod or heat setting required for every situation. The type and thickness of metal and the position of the workpiece determine the electrode type and the amount of heat needed in the welding process. Heavier and thicker metals require more amperage. It is best to practice your welds on scrap metal which matches the metal you intend to work with to determine correct heat setting and electrode choice. See the following troubleshooting tips to determine if you are using the correct electrode.

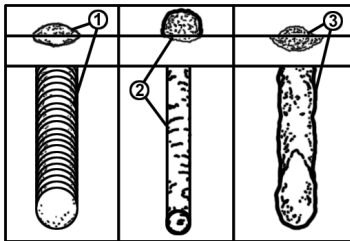

1. WHEN THE PROPER ROD IS USED:

- The bead will lay smoothly over the work without ragged edges.
- The base metal puddle will be as deep as the bead that rises above it.
- The welding operation will make a crackling sound similar to the sound of eggs frying.

2. WHEN A ROD TOO SMALL IS USED:

- The bead will be high and irregular.
- The arc will be difficult to maintain.

3. WHEN THE ROD IS TOO LARGE:

- The arc will burn through light metals.
- The bead will undercut the work.
- The bead will be flat and porous.
- The rod may freeze or stick to the workpiece.

WARNING!

Rate of travel over the work also affects the weld. To ensure proper penetration and enough deposit of rod, the arc must be moved slowly and evenly along the weld seam.

THIS WELDING MACHINE MUST BE CONNECTED TO POWER SOURCE IN ACCORDANCE WITH APPLICABLE ELECTRICAL CODES.

1. SETTING THE AMPERAGE CONTROL

The welder has an infinite output current control. It is capable of welding with 1/16, 5/64, 3/32 electrodes.

There is no golden rule that determines the exact amperage required for every situation. It is best to test your welds on scrap metal which matches the metals you intend to work with to determine correct setting for your job. The electrode type and the thickness of the workpiece metal determine the amount of heat needed in the welding process. Heavier and thicker metals require more voltage (amperage), whereas lighter and thinner metals require less voltage (amperage).

2. WELDING TECHNIQUES

The best way to teach yourself how to weld is with short periods of practice at regular intervals. All practice welds should be done on scrap metal that can be discarded. Do not attempt to make any repairs on valuable equipment until you have satisfied yourself that your practice welds are of good appearance and free of slag or gas inclusions.

2.1 HOLDING THE ELECTRODE

The best way to grip the electrode holder is the way that feels most comfortable to you. To position the electrode to the workpiece when striking the initial arc it may be necessary to hold the electrode perpendicular to the workpiece. Once the arc is started the angle of the electrode in relation to the workpiece should be between 10 and 30 degrees. This will allow for good penetration, with minimal spatter.

2.2 STRIKING THE ARC

Scratch the work piece with the end of the electrode to start an arc and then raise it quickly to about a 1/8" gap between the rod and the workpiece.

See the following picture: It is important that the gap be maintained during the welding process and it should be neither too wide nor too narrow. If too narrow, the rod will stick to the workpiece. If too wide, the arc will be extinguished. It needs much practice to maintain the gap. Beginners may usually get sticking or arc extinguishing. When the rod sticks to the workpiece, gently rock it back and forth to make it release. If not, the circuit will be shorted, and it will overload the welder. A good arc is accompanied by a crisp, crackling sound. The sound is similar to that made by eggs frying. To lay a weld bead, only 2 movements are required; downward and in the direction the weld is to be laid, as in the following figure:

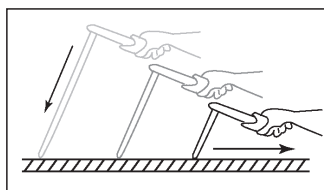
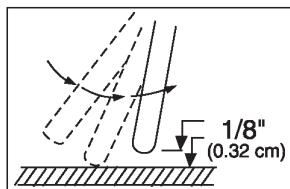

2.3 TYPES OF WELD BEAD

The following paragraphs discuss the most commonly used arc welding beads. The stringer bead is formed by travelling with the electrode in a straight line while keeping it centred over the weld joint.

The weave bead is used when you want to deposit metal over a wider space than would be possible with a stringer bead. It is made by weaving from side to side while moving with the electrode. It is best to hesitate momentarily at each side before weaving back the other way to improve penetration.

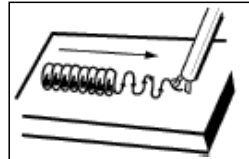
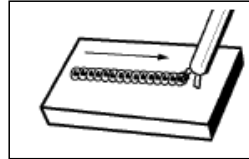

2.4 WELDING POSITION

The flat position is the easiest of the welding positions and is most commonly used. It is best if you can weld in the flat position if at all possible as good results are easier to achieve. The horizontal position is performed very much the same as the flat weld except that the angle is different such that the electrode, and therefore the arc force, is directed more toward the metal above the weld joint. This more direct angle helps prevent the weld puddle from running downward while still allowing slow enough travel speed to achieve good penetration.

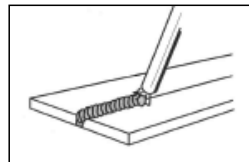

A good starting point for your electrode angle is about 30 degrees DOWN from being perpendicular to the workpiece.

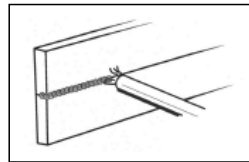

2.5 JUDGE A GOOD WELD BEAD

When the trick of establishing and holding an arc has been learned, the next step is learning how to run a good bead. The first attempts in practice will probably fall short of acceptable weld beads. Too long an arc will be held or the travel speed will vary from slow to fast. See the following picture:

- A. Weld speed is too fast.
- B. Weld speed is too slow.
- C. Arc is too long.
- D. Ideal weld.

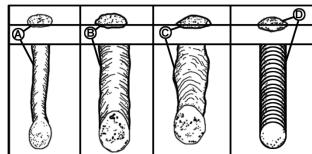

A solid weld bead requires that the electrode be moved slowly and steadily along the weld seam. Moving the electrode rapidly or erratically will prevent proper fusion or create a lumpy, uneven bead. To prevent ELECTRIC SHOCK, do not perform any welding while standing, kneeling, or lying directly on the grounded work.

2.6 FINISH THE BEAD

As the coating on the outside of the electrode burns off, it forms an envelope of protective gasses around the weld. This prevents air from reaching the molten metal and creates an undesirable chemical reaction. The burning coating, however, forms slag. The slag formation appears as an accumulation of dirty metal scale on the finished weld. Slag should be removed by striking the weld with a chipping hammer. The intense heat produced at the arc sets up strains in the metals joined by welding. Peening the weld not only removes the scale left behind in the welding but relieves the internal strains developed by the heating and cooling process. Use a hammer or brush after the workpiece has cooled.

⚠ WARNING!

- Always wear qualified safety goggles and full face shield when using the welder.

TROUBLESHOOTING

The welder needs regular maintenance:

- Periodically clean dust, dirt, grease, etc., from your welder. Every six months, or as necessary, remove the cover panel from the welder and air-blow any dust and dirt that may have accumulated inside the welder.
- Replace power cord, ground cable, ground clamp, or electrode assembly when damaged or worn.
- Store in a clean, dry facility, free from corrosive gas, excess dust and high humidity. Store in a temperature range from -12 to 490C (10 to 1200F) and relative humidity not more than 90%.
- When transporting or storing the welder after use, it is recommended to repack the product as it was received for protection. Cleaning is required before storage and you must seal the plastic bag in the box for storage.

Problem	Possible Cause	Corrective Action
Welder does not work when the main switch is turned on.	<ol style="list-style-type: none"> 1. No power input. 2. The power cord or power plug is broken. 3. Main switch is broken. 	<ol style="list-style-type: none"> 1. Check circuit breaker or fuse in power source. 2. Replace power cord. 3. Replace switch.
Does not weld.	<ol style="list-style-type: none"> 1. Incorrect power input. 2. Inadequate current at output. 3. Poor connection of output cable. 4. Dirty surfaces. 5. Wrong welding wire. 	<ol style="list-style-type: none"> 1. Check the power source. 2. Check for proper grounding to the workpiece. 3. Check output connection. 4. Clean surfaces. 5. Use correct wire.
Blows fuse.	Wrong fuse in power supply.	Check the fuse in power source. It should be a 25 A fuse.
Arc is hard to start.	<ol style="list-style-type: none"> 1. The wrong electrode. 2. Base metal not grounded properly. 	<ol style="list-style-type: none"> 1. Use recommended electrode. 2. Make sure there is a good ground connection.
Welding bead too thin.	The welding speed is too fast.	Slow down the welding speed.
Welding bead too thick.	The welding speed too slow.	Speed up the welding speed.
Electrode sticks to work piece.	Electrode is in contact with the work piece too long when starting arc.	After the arc has started, move the electrode away from the workpiece immediately.
Poor welding performance; spatter.	<ol style="list-style-type: none"> 1. Damp electrode. 2. Wrong type electrode. 	<ol style="list-style-type: none"> 1. Use dry one. 2. Use correct one.

EXPLODED VIEW

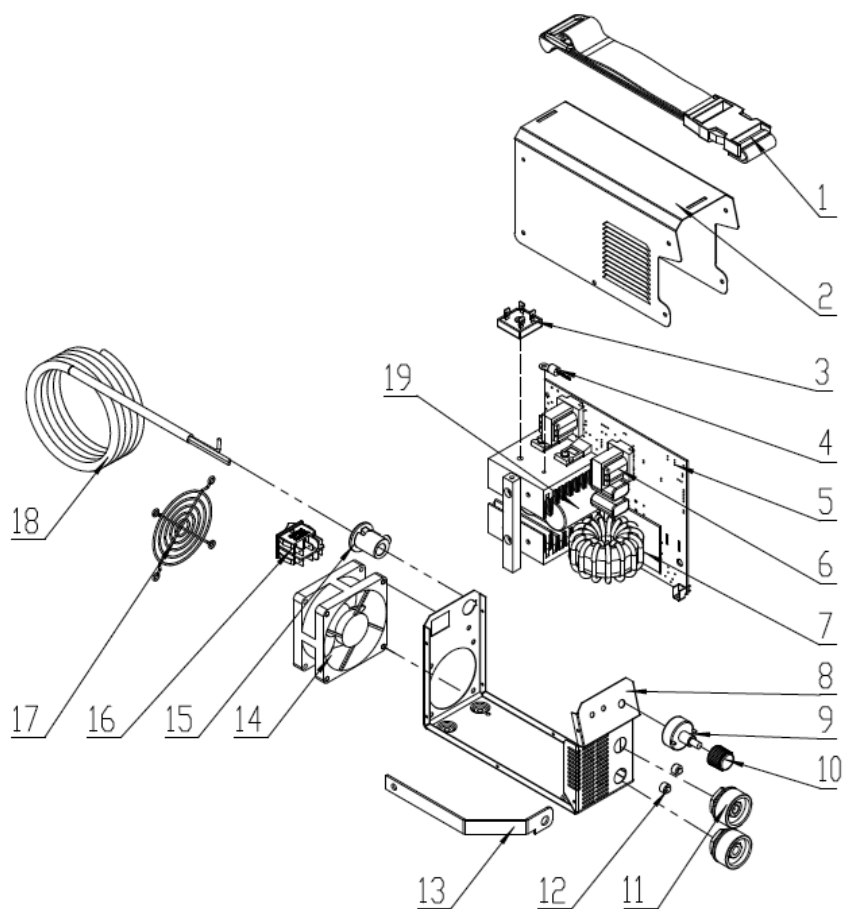

PARTS LIST

⚠ WARNING: When servicing, use only original equipment replacement parts. The use of any other parts may create a safety hazard or cause damage to the stick welder.

Any attempt to repair or replace electrical parts on this stick welder may create a safety hazard unless repairs are performed by a qualified technician.

For more information, call the Toll-free Helpline, at 1-866-349-8665;

Monday - Friday: 9am to 5pm Eastern Standard Time.

Always order by key number.

Key #	Part #		Quantity
1	1150-000-001	Straps	1
2	1150-000-002	Enclosure	1
3	1150-000-003	Rectifier	1
4	1150-000-004	NTC Harnesses	1
5	1150-000-005	Main Control PCB	1
6	1150-000-006	Transformer	1
7	1150-000-007	Main Transformer	1
8	1150-000-008	Front & Back Plate	1
9	1150-000-009	Potentiometer Harnesses	1
10	1150-000-010	Knob	1
11	1150-000-011	Quick Connector	2
12	1150-000-012	Indicator	2
13	1150-000-013	Connection Bar	1
14	1150-000-014	Fan	1
15	1150-000-015	Cable Clamp	1
16	1150-000-016	Power Switch	1
17	1150-000-017	Fan Cover	1
18	1150-000-018	Power Cable	1
19	1150-000-019	Capacitor	4

WARRANTY

RADLEY STICK WELDER

If this Radley tool fails due to a defect in material or workmanship within three years from the date of purchase, return it to any Home Hardware store with the original bill of sale for exchange. Two year warranty for the battery and charger. This warranty does not include expendable parts including but not limited to blades, brushes, belts, light bulbs.

This warranty covers defects in material or workmanship only. It does not cover normal wear and tear, failure due to abuse/misuse, or defects caused by careless or accidental mishandling. If this Radley product is used for commercial or rental purposes, this warranty does not apply.

Radley[®]

INVERTER STICK WELDER KIT

OWNER'S MANUAL



3 Year Limited Warranty on tool

Radley[®]

RADLEY TOOLS
ST. JACOBS, ONTARIO N0B 2N0
© 2022 Home Hardware Stores Limited
1-866-349-8665
Customer Service/Tech Support

1150-000

Made in China

**3 Year
warranty**

If this Radley Tool fails due to a defect in material or workmanship within three years from the date of purchase, return it to any Home Hardware store with the original bill of sale for exchange. Two years for battery and charger.

CSA[®]
C US
229683
EXTREME 80

READ ALL INSTRUCTIONS BEFORE FIRST USE. KEEP THIS MANUAL FOR FUTURE REFERENCE. KEEP AWAY FROM CHILDREN.

This warranty does not include expendable parts including but not limited to blades, brushes, belts, and light bulbs. This warranty covers defects in material or workmanship only. It does not cover normal wear and tear, failure due to abuse/misuse, or defects caused by careless or accidental mishandling. If this Radley product is used for commercial or rental purposes, this warranty does not apply. For use at the consumer level. The warranty is not for industrial or commercial applications.



**WEAR CSA APPROVED
EYE PROTECTION**



**WEAR EAR
PROTECTION**



**WEAR FACE
PROTECTION**