

Radley®

40V Max* Chain Saw

Oregon® 14" Bar



Brushless motor technology
Includes 2 batteries
and 1 charger



Owner's Manual
3 Year limited warranty



READ ALL INSTRUCTIONS BEFORE FIRST USE.
KEEP THIS MANUAL FOR FUTURE REFERENCE.
KEEP AWAY FROM CHILDREN.

*Uses two 20V Max lithium-ion batteries that deliver an initial battery voltage (measured without a workload) of 40 volts. Nominal voltage is 36V.



WEAR CSA APPROVED
EYE PROTECTION



WEAR EAR
PROTECTION



WEAR A
FACE MASK

PRODUCT SPECIFICATIONS

BRUSHLESS CHAINSAW	
Voltage	40V (2 x 20V) No load
Chain speed	14.5 m/s
Chain length	14" /35.6cm
Drive links	52
Chain pitch	3/8"
Chain gauge	0.05"
Weight	11½ lb / 5.21 kg

BATTERY AND CHARGER	
Battery voltage:	2x20V 2.0 Ah Li-ion (Maximum charged battery voltage, each measured without load, is 20V and each with a nominal value of 18V)
Charger	Up to 70 minutes
Replacement battery	5350-547
Replacement charger	5350-046

Need Assistance?

Call us on our toll free customer support line:

1-866-349-8665 (Monday through Friday 9am – 5pm Eastern Time)

- Technical questions
- Replacement parts
- Parts missing from package

TABLE OF CONTENTS

Product specifications	1
Table of contents	2
General safety warnings	3-5
Always wear ear protection	3
Work area safety	3
Electrical safety	3-4
Personal safety	4
Chainsaw use and care	4-5
Service	5
Specific safety rules	6-9
Causes and operator prevention of kickback	8
Vibration and noise reduction	9
Emergency	9
Residual risks	9
Important safety instructions	10-13
For battery pack	10
For charger	10-11
Safety precaution when using charger and battery	11-12
Disposal of the exhausted battery	12
Preparation for recycling of battery pack	12
Tips for maintaining maximum battery life	12
Removing battery pack	13
Battery pack recycling	13
Symbols	14
Know your brushless chainsaw	15
Checking the battery charge status	16
Assembly and operating	16-18
Charging the battery pack	16-17
Installing a battery on the chainsaw	17-18
Installing and removing battery pack	18
Assembly	19-22
Operation	22-28
Maintenance	28-29
Replace saw chain and guide bar	28
Sharpening the saw chain	29
Cleaning and storage	29
Information on environmental protection and disposal	29
Exploded view	30
Parts list	31-33
Warranty	34

GENERAL SAFETY WARNINGS

 **WARNING:** Not for use on wet materials.

 **WARNING:** Disconnect the battery before cleaning or changing accessories.

 **WARNING:** To avoid serious personal injury, do not attempt to use this product until you have read this instruction manual thoroughly and understand it completely. If you do not understand the warnings and instructions in this instruction manual, do not use this product. Call 1-866-349-8665 for assistance. The operation of any power tool can result in foreign objects being thrown into your eyes, which can result in severe eye damage. Before beginning power tool operation, always wear safety goggles or safety glasses with side shields and, when needed, a full face shield. We recommend a wide vision safety mask for use over eyeglasses or standard safety glasses with side shields. Always use eye protection which is marked to comply with ANSI Z87.1 or CSA requirements. Prescription eyeglasses ARE NOT a replacement for proper eye protection. **WARNING:** Noncompliant eyewear can cause serious injury if broken during the operation of a power tool.

ALWAYS WEAR EAR PROTECTION

 **WARNING:** Use hearing protection, particularly during extended periods of operation of the tool, or if the operation is noisy.

WORK AREA SAFETY

Keep work area clean and well lit. Cluttered or dark areas invite accidents.

Do not operate chainsaw in explosive atmospheres, such as in the presence of flammable liquids, gases, or dust. Chainsaws create sparks which may ignite the dust or fumes.

Keep children and bystanders away while operating a power tool. Distractions can cause you to lose control.

ELECTRIC GARDENING TOOL SAFETY

GENERAL SAFETY WARNINGS

 **WARNING:** Read all safety warnings and all instructions. Failure to follow the warnings and instructions may result in electric shock, fire and/or serious injury.

Save all warnings and instructions for future reference.

General Electric Gardening Tool Safety Warnings – Work Area Safety

Do not operate power tools in explosive atmospheres, such as in the presence of flammable liquids, gases or dust. Power tools create sparks which may ignite the liquids, fumes or dust.

Keep children and bystanders away while operating a power tool. Distractions can cause you to lose control.

SAVE THESE INSTRUCTIONS FOR REFERENCE

General Electric Gardening Tool Safety Warnings – Electrical Safety

Battery charger plugs must match the outlet. Never modify the plug in any way.

Do not use any adapter plugs with earthed (grounded) chargers. Unmodified plugs and matching outlets will reduce risk of electric shock.

Avoid body contact with earthed or grounded surfaces such as water pipes. There is an increased risk of electrical shock if your body is earthed or grounded.

Do not expose power tools, battery chargers or batteries to rain or wet conditions.

Water entering the tool, chargers or batteries will increase the risk of electric shock.

Do not abuse the cord. Never use the power cord for carrying, pulling or unplugging the charger. Keep the power cord away from heat, oil, sharp edges, and moving parts. Damaged or entangled cords increase the risk of electric shock.

When operating the charger outdoors, use an extension cord suitable for outdoor use. Use of a cord suitable for outdoor use reduces the risk of electric shock.

Never operate a power tool in the rain.

If operating a charger in a damp location is unavoidable, use a residual current device (RCD) protected supply. An RCD is also known as a ground fault circuit interrupter (GFCI) or earth leakage circuit breaker (ELCB). Use of an RCD reduces the risk of electric shock.

PERSONAL SAFETY

Stay alert, watch what you are doing and use common sense when operating a chainsaw. Do not use a chainsaw while you are tired or under the influence of drugs, alcohol or medication. A moment of inattention while operating chainsaws may result in serious personal injury.

Use personal protective equipment. Always wear eye protection. Protective equipment such as dust mask, nonskid safety shoes, hard hat, or hearing protection used for appropriate conditions will reduce personal injuries.

Prevent unintentional starting. Ensure the switch is in the off-position before connecting to power source and/or battery pack, picking up or carrying the tool. Carrying power tools with your finger on the switch or energizing power tools that have the switch on invites accidents.

Remove any adjusting key or wrench before turning the power tool on. A wrench or a key left attached to a rotating part of the chainsaw may result in personal injury.

Do not overreach. Keep proper footing and balance at all times. This enables better control of the chainsaw in unexpected situation.

READ ALL INSTRUCTIONS BEFORE USING THIS BRUSHLESS CHAINSAW

Dress properly. Do not wear loose clothing or jewellery. Keep your hair, clothing and gloves away from moving parts. Loose clothes, jewellery or long hair can be caught in moving parts.

If devices are provided for the connection of dust extraction and collection facilities, ensure these are connected and properly used. Use of dust collection can reduce dust-related hazards.

CHAINSAW USE AND CARE

Do not force the chainsaw. Use the correct chainsaw for your application. The correct chainsaw will do the job better and safer at the rate for which it was designed.

Do not use the chainsaw if the switch does not turn it on and off. Any chainsaw that cannot be controlled with the switch is dangerous and must be repaired.

Disconnect the plug from the power source or batteries before making any adjustments changing accessories, or storing chainsaws. Such preventive safety measures reduce the risk of starting the chainsaw accidentally.

Store idle chainsaws out of the reach of children and do not allow persons unfamiliar with the chainsaw or these instructions to operate the chainsaw. Chainsaws are dangerous in the hands of untrained users.

Maintain chainsaws. Check for misalignment or binding of moving parts, breakage of parts and any other condition that may affect the chainsaw's operation. If damaged, have the chainsaw repaired before use. Many accidents are caused by poorly maintained chainsaws.

Keep cutting tools sharp and clean. Properly maintained cutting tools with sharp cutting edges are less likely to bind and are easier to control.

Use the chainsaw, accessories and tool bits etc. in accordance with these instructions, taking into account the working conditions and the work to be performed. Use of the chainsaw for operations different from those intended could result in a hazardous situation.

Hold power tools by insulated gripping surfaces when performing an operation where the cutting tool may contact hidden wiring or its own cord. Contact with a "live" wire will make exposed metal parts of the tool "live" and shock the operator.

SERVICE

Have your power tool serviced by a qualified repair person using only identical replacement parts. This will ensure that the safety of the power tool is maintained.

SAVE THESE INSTRUCTIONS FOR REFERENCE

SPECIFIC SAFETY RULES

Keep all parts of the body away from the saw chain when the chainsaw is operating. Before you start the chainsaw, make sure the saw chain is not contacting anything. A moment of inattention while operating chainsaws may cause entanglement of your clothing or body with the saw chain.

Note: The size of the work area depends on the job being performed as well as the size tree or work piece involved. For example, felling a tree requires a larger work area than making bucking cuts.

Always hold the chainsaw with your right hand on the rear handle and your left hand on the front handle. Holding the chainsaw with a reversed hand configuration increases the risk of personal injury and should never be done.

Hold the chainsaw by insulated gripping surfaces only, because the saw chain may contact hidden wiring or its own cord. Saw chains contacting a live wire may make exposed metal parts of the chainsaw live and could give the operator an electric shock.

Wear safety glasses and hearing protection. Further protective equipment for head, hands, legs and feet must be worn. Adequate protective clothing will reduce personal injury by flying debris or accidental contact with the saw chain.

Do not operate a chainsaw in a tree. Operation of a chainsaw while up in a tree may result in personal injury.

Always keep proper footing and operate the chainsaw only when standing on fixed, secure and level surface. Slippery or unstable surfaces such as ladders may cause a loss of balance or control of the chainsaw.

When cutting a limb that is under tension be alert for springback. When the tension in the wood fibres is released the limb under tension may strike the operator and/or throw the chainsaw out of control.

Use extreme caution when cutting brush and saplings. The slender material may catch the saw chain and be whipped toward you or pull you off balance.

Carry the chainsaw by the front handle with the chainsaw switched off and away from your body. When transporting or storing the chainsaw always fit the guide bar cover. Proper handling of the chainsaw will reduce the likelihood of accidental contact with the moving saw chain.

READ ALL INSTRUCTIONS BEFORE USING THIS BRUSHLESS CHAINSAW

Always use two hands when operating the chainsaw.

Contact of the guide bar tip with any object should be avoided.

Tip contact may cause the guide bar to move suddenly upward and backward, which may cause serious injury.

Follow instructions for lubricating, chain tensioning and changing accessories. Improperly tensioned or lubricated chain may either break or increase the chance for kickback.

Keep handles dry, clean, and free from oil and grease. Greasy, oily handles are slippery causing loss of control.

Cut wood only. Do not use chainsaw for purposes not intended. For example: do not use chainsaw for cutting plastic, masonry or non-wood building materials. Use of the chainsaw for operations different than intended could result in a hazardous situation.

 **WARNING:** Some dust created by power sanding, sawing, grinding, drilling, and other construction activities contain chemicals known to cause cancer, birth defects or other reproductive harm. Some examples of these chemicals are: 1. Lead from lead-based paints. 2. Crystalline silica from bricks and cement and other masonry products, and 3. Arsenic and chromium from chemically-treated lumber. Your risk from these exposures varies, depending on how often you do this type of work. To reduce your exposure to these chemicals, work in a well-ventilated area, and work with approved safety equipment, such as those dust masks that are specially designed to filter out microscopic particles.

Use the chainsaw, accessories and tool bits etc. in accordance with these instructions, taking into account the working conditions and the work to be performed. Use of the chainsaw for operations different from those intended could result in a hazardous situation.

SAVE THESE INSTRUCTIONS FOR REFERENCE

CAUSES AND OPERATOR PREVENTION OF KICKBACK

⚠ WARNING: Kickback may occur when the moving chain contacts an object at the upper portion of the tip of the guide bar or when the wood closes in and pinches the saw chain in the cut. Contact at the upper portion of the tip of the guide bar can cause the chain to dig into the object and stop the chain for an instant. The result is a lightning fast reverse reaction which kicks the guide bar up and back toward the operator. If the saw chain is pinched along the top of the guide bar, the guide bar can be driven rapidly back toward the operator. Either of these reactions can cause loss of saw control which can result in serious injury. Do not rely exclusively upon the safety devices built into the saw. As a chainsaw user, you should take several steps to keep your cutting jobs free from accident or injury.

Maintain a firm grip, with thumbs and fingers encircling the chainsaw handles, with both hands on the saw and position your body and arm to allow you to resist kickback forces. Kickback forces can be controlled by the operator, if proper precautions are taken. Do not let go of the chainsaw.

Do not overreach and do not cut above shoulder height. This helps prevent unintended tip contact and enables better control of the chainsaw in unexpected situations.

Only use replacement bars and chains specified by the manufacturer. Incorrect replacement bars and chains may cause chain breakage and/or kickback.

Follow the manufacturer's sharpening and maintenance instructions for the saw chain. Decreasing the depth gauge height can lead to increased kickback.

With a basic understanding of kickback, you can reduce or eliminate the element of surprise. Sudden surprise contributes to accidents.



Attention! It is recommended that first time user should practice cutting logs on a sawhorse or frame by removing the battery.

READ ALL INSTRUCTIONS BEFORE USING THIS BRUSHLESS CHAINSAW

VIBRATION AND NOISE REDUCTION

To reduce the influence of vibration and noise, limit working hours and wear personal protective equipment. Observe the following points to minimize vibration and noise exposure:

1. Use the product only in accordance with its design and instructions.
2. Ensure that the product is in good condition and well maintained.
3. Use the correct accessories and ensure that they are in good condition.
4. Hold the product firmly but not tightly by the handles provided.
5. Maintain the product according to these instructions and keep it well lubricated.
6. Plan your working hours according to these instructions in order to spread a higher load over a longer period of time.

EMERGENCY

Familiarize yourself with the use of the product by reading this manual completely. Make a note of the safety instructions and follow them carefully. This will help you prevent risks and hazards.

- a) Always be careful when using the product so that you can identify and react to hazards early. Quick intervention can prevent serious injury and property damage.
- b) Switch off the product by removing the battery if problems occur. Have the product repaired by a qualified expert, if necessary, before reusing the product.

RESIDUAL RISKS

Even if you operate this power tool correctly, there are always residual risks. The following hazards may occur in connection with the construction and design of this power tool:

- a) Injuries and material damage caused by flying parts.
- b) Hearing damage if you do not wear suitable hearing protection or use the power tool for a long period of time.
- c) Damage to health resulting from hand-arm vibrations if the power tool is used for an extended period of time or is not properly operated and maintained.

SAVE THESE INSTRUCTIONS FOR REFERENCE

IMPORTANT SAFETY INSTRUCTIONS

1. FOR BATTERY PACK

- a) Before using the battery pack, read all instructions and cautionary markings on battery pack, charger and product using battery pack.
- b) If operating time has become excessively shorter, stop operating immediately. It may result in a risk of overheating and possible burns.
- c) Do not short the battery pack:
 - 1) Do not touch the terminals with any conductive material.
 - 2) Avoid storing battery pack in a humid environment.
 - 3) Do not expose the battery pack to water or rain. A short circuit of the battery can cause a large current flow, overheating, possible burns and even a breakdown.
- d) Do not store the tool and battery pack in locations where the temperature may exceed 105° F (40.5° C).
- e) Do not incinerate the battery pack even if it is severely damaged or is completely worn out. The battery pack can explode in a fire.
- f) Be careful not to drop or strike the battery.
- g) Do not use a damaged battery.

2. FOR CHARGER

- a) Before charging, study the instruction manual carefully.
- b) Before charging the battery, connect the power cord into the power supply first and then connect the battery pack with the charger. Once the battery is fully charged, disconnect the power supply after removing the battery pack from the charger.
- c) This device is for indoor use only. Water, rain or moisture should be strictly prohibited.
- d) Correct use: chargers are to be used exclusively for charging 20V Radley Rechargeable Battery Packs. Any other application may result in risk of fire, electric shock or electrocution. The user bears sole responsibility for any damage caused by inappropriate use. The generally recognized accident prevention regulations and the safety instructions which accompany them must be adhered to.
- e) The charger is specifically designed to charge 20V Max Radley Battery Packs. Do not attempt to charge any other battery with this charger.



CAUTION: Replace the battery only with the same designed battery type.

READ ALL INSTRUCTIONS BEFORE USING THIS BRUSHLESS CHAINSAW

- f) Do not expose the charger to rain, snow or other extreme climate conditions. Do not use power tools in damp or wet locations.
- g) The use of any attachment not recommended or supplied by the battery charger manufacture may result in a risk of fire, electric shock, or injury to persons.
- h) To reduce risk of damage to electric plug and cord, pull by plug rather than cord when disconnecting charger.
- i) Make sure cord is appropriately located so that it will not be stepped on, tripped over, or otherwise subject to damage or stress.
- j) Do not operate charger with damaged cord or plug. Please replace immediately .
- k) Do not operate charger if it has received a sharp blow, been dropped, or otherwise damaged in any way.
- l) Do not disassemble charger, please contact toll free service at 1-866-349-8665. Incorrect reassembly may result in a risk of electric shock or fire.
- m) To reduce risk of electric shock, unplug charger from outlet before attempting any maintenance or cleaning.
- n) Charging must only be performed when the battery pack temperature is between 41° F / 5° C and 105° F / 40.5° C.
- o) The charger is designed to operate on standard household electrical power. Do not attempt to use it on any other voltage.

 **WARNING:** The parts inside the charger are live and can create a shock hazard! Do not stick anything in the battery charger terminal slots.

- p) Unplug the charger immediately if there is any sign of smoke or flame.
- q) Do not drill into the housing of the charger or battery pack.
- r) Keep the charger away from children.

3) SAFETY PRECAUTION WHEN USING CHARGER AND BATTERY

- a) Do not charge battery when temperature is below 40° F / 5° C or above 105° F / 40.5° C. The most suitable temperature for charging is that of 68-77° F / 20-25° C .
- b) Do not insert objects into the hole reserved for the battery in the charger.
- c) Never short circuit the battery. Short circuiting the battery will severely damage the battery and could cause a fire or explosion.
- d) This appliance is not intended for use by persons, including children, or those with reduced physical, sensory or mental capabilities, or lack of experience and knowledge, unless they have been given supervision or instruction concerning use of the appliance by a person responsible of their safety.

SAVE THESE INSTRUCTIONS FOR REFERENCE

- e) Children should be supervised to ensure that they do not play with the tool.
- f) Do not dispose of electrical appliances as unsorted municipal waste, use separate collection facilities.
- g) If electrical appliances are disposed of in landfills or dumps, hazardous substances can leak into the food chain, damaging your health and well-being.
- h) If the cord is damaged, it must be replaced by the manufacturer or similarly qualified persons in order to avoid a hazard.

⚠ WARNING: If any parts are missing, do not operate tool until the missing parts are replaced. Failure to do so could result in possible serious personal injury.

4) DISPOSAL OF THE EXHAUSTED BATTERY

For safety and to preserve natural resources, please recycle or dispose of properly. This product contains Lithium-ion. Battery must be disposed of properly. Local, provincial, or federal laws may prohibit disposal of Lithium-ion batteries in ordinary trash. Consult your local waste authority for information regarding available recycling and / or disposal options.

5) PREPARATION FOR RECYCLING OF BATTERY PACK

⚠ WARNING: Do not attempt to destroy or disassemble the battery pack or remove any of its components. Do not touch terminals with metal objects as short-circuit may result. Keep away from children. Failure to comply with these warnings could result in fire and / or serious injury.

6) TIPS FOR MAINTAINING MAXIMUM BATTERY LIFE

- a) Charge the battery pack before completely discharged. Always stop tool operation and charge the battery pack when you notice a decrease in tool power.
- b) Charge the battery pack between 41-105° F (5-40.5° C). Let a hot battery pack cool down before charging it.
- c) Charge the battery pack once every 6 months if you do not use it for a long period of time. Li-ion battery is known to self discharge over time.

READ ALL INSTRUCTIONS BEFORE USING THIS BRUSHLESS CHAINSAW

7) INSTALLING OR REMOVING BATTERY PACK

- a) Hold the tool and the battery pack firmly when installing or removing battery pack. Failure to hold the tool and the battery pack firmly may cause them to slip out of your hands and result in damage to the tool, battery pack and could result in personal injury.
- b) Always switch off the tool before installing or removing the battery pack.
- c) To remove battery pack, press the release button, and pull out.
- d) To install the battery pack with the charger, align the terminal pin on the charger and slide the battery into the charger.

⚠ NOTE: Do not use force when installing the battery pack. If the battery pack does not slide in easily, it is not being inserted correctly.

⚠ WARNING: Verify that the switch on the tool is in the OFF position before inserting or removing the battery pack.

⚠ This power tool generates an electromagnetic field during operation. This field may affect active or passive medical implants under certain circumstances.
To reduce the risk of serious or fatal injury, we recommend that persons with medical implants consult their physician and the manufacturer of the medical implant before operation of this tool.











BATTERY PACK RECYCLING

To preserve our natural resources, please recycle or dispose of batteries properly. The batteries charged by this charger may contain chemicals and metals that are harmful to the environment. Never dispose of rechargeable batteries in your normal household garbage or in landfill sites as they will add to the pollution of the environment.



SAVE THESE INSTRUCTIONS FOR REFERENCE

SYMBOLS

	Read the user manual before using the machine.		Warning! Danger! Note!
	Whenever the tool is in use, safety goggles must be worn to safeguard against flying objects. Ear protectors, such as a soundproof helmet must be worn to protect the operator's hearing. If the operator is working in an area where there is a risk of falling objects, a safety helmet must also be worn.		Do not expose to rain.
			Wear safety boots to protect against electric shock.
			Wear gloves to protect your hands.
			ATTENTION! Do not throw the battery into the household waste.
	Li-Ion Battery.		Do not expose the battery to strong sunlight for long periods of time and do not place it on radiators (max. 122° F / 50°C).
	Protection temperature limitation.		The charger is suitable for indoor use only.



800874
GY0191

This symbol designates that this tool is listed with Canadian and U.S. requirements by cSGSus Testing Laboratories, Inc.

UL 60745-1; UL 60745-2-13

KNOW YOUR BRUSHLESS CHAINSAW

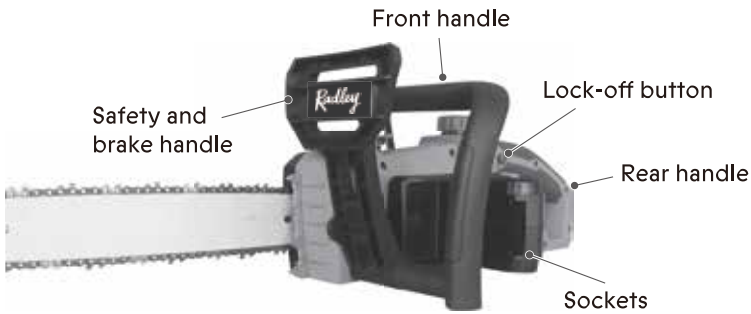
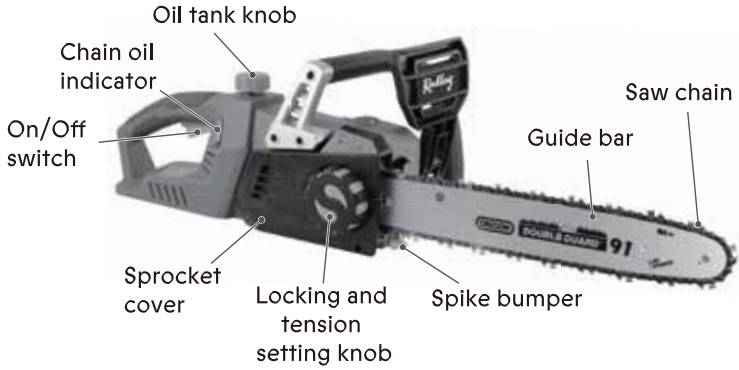

Battery charger
5350-046

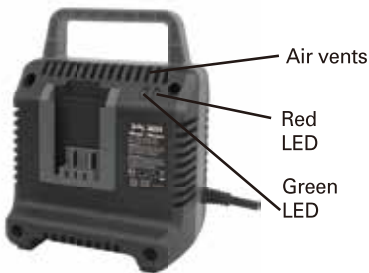

CHECKING THE BATTERY CHARGE STATUS

The level of charge remaining in the battery can be checked by using the battery LED power indicator that is contained on the end of the battery.

NOTE: The battery charge remaining may be checked while the battery is installed in the tool with the ON/OFF switch turned OFF. It may also be checked while the battery is removed from the tool. DO NOT check the battery charge remaining while the battery is in the charger. You will get a false reading and you may also damage the battery status system.

1. Press and hold the battery status button located on the end of the battery.
2. One or more of the three LED lights in the LED window will come ON to indicate the amount of charge that is remaining in the battery as follows:

1 light (Red light ON)	2 lights (Red and Orange light ON)	3 lights (Red/Orange/Green ON)
1/3 or less	1/3 - 2/3	2/3-Fully charged



3. Release the battery status button to turn the LED's OFF.

ASSEMBLY AND OPERATING

CHARGING THE BATTERY PACK

1. Place the battery charger (1) in a dry location near a 110–120V 60 Hz electrical outlet (Fig. 1).
2. Plug the battery charger into the outlet and make sure the green LED indicator light (5) comes ON. If it does not, refer to the chart (Fig. 2) to identify the problem.
3. Turn the battery (2) upside down and slide it onto the charger.

NOTE: Make sure the grooves (3) in the sides of the battery slide over the matching tabs on the charger (4) until the battery latch “clicks” into place.

NOTES:

1. When the charger is plugged into the wall receptacle and NO battery is on the charger, the green indicator light (5) will turn ON indicating the charger is “live”.
2. When a discharged battery is installed on the charger, the green indicator light will turn OFF and the red indicator light (6) will turn ON. The red indicator light indicates the battery is being charged.
3. If the red indicator light does not come ON, check to make sure battery pack is slid fully onto the charger and the electrical outlet is working properly.
4. See Fig. 2 for other indicator light functions.
5. A discharged battery pack should be fully charged in 70minutes.
6. It is normal for the battery charger to hum and be warm to the touch during operation.
7. If the battery pack does not charge properly, check to make sure the electrical outlet is “live”.
8. Do NOT charge batteries when the work area or the battery temperature is at or below 41° F / 5° C or above 105° F / 40.5° C.

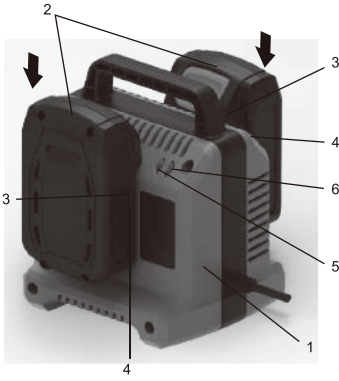

Fig. 1

Green Light	Red Light	Battery Inserted Into Charger	Charging Status
ON	OFF	NO	Charger connected to power supply.
OFF	ON	YES	Battery being charged.
ON	OFF	YES	Battery fully charged.
ON	OFF	YES	Battery is charged but not operational on tool. This may indicate defective / bad contact on battery or charging conditions are either too hot or too cold.

Fig. 2

INSTALLING A BATTERY ON THE CHAINSAW

1. Remove the discharged battery (1) from the chainsaw by pressing downward on the battery release button (2) and sliding the battery backward until it is removed from the chainsaw port (3-1 & 3-2) (Fig. 3).
2. Slide the fully charged battery onto the matching keys (4) in the chainsaw port (3-1 & 3-2) where the discharged battery has been removed.



Fig. 3

NOTE: Make sure the slots in the battery are fully engaged with the mounting keys in the chainsaw port (3-1 & 3-2). The battery release button will “click” into place when the battery is fully installed.

WARNING: Do not immerse the battery pack in water. Sudden cooling could cause a hot battery to implode or leak.

⚠ WARNING! If any parts are damaged or missing, do not operate this product until the parts are replaced. Use of this product with damaged or missing parts could result in serious personal injury.

⚠ WARNING! Do not install the batteries until assembly is complete. Failure to comply could result in accidental starting and possible serious personal injury.

⚠ WARNING! Do not attempt to modify this product or create accessories not recommended for use with this product. Any such alteration or modification is misuse and could result in a hazardous condition leading to possible serious personal injury.

INSTALLING AND REMOVING BATTERY PACK

⚠ WARNING! Always remove the battery pack from your tool when you are assembling parts, making adjustments, cleaning, carrying, transporting or when not in use. Removing the battery packs will prevent accidental starting that could cause serious personal injury.

Slide a battery pack into one of the slots until it clicks into place, (Fig.4). (Note the battery has raised ribs which allows it to fit into the machine only one way). Repeat this procedure for the second battery.

To remove the battery, press the battery release button, and pull the battery pack out of the slot, (Fig.5).

NOTE: The tool will only work when two batteries are installed.



Fig. 4



Fig. 5

ASSEMBLY

- !** Safety precautions must be observed when using tool to prevent injury and damage:
- * Please read the operating instructions carefully and follow the instructions. Use these instructions to familiarize yourself with the tool, its correct use and safety regulations.
 - * Keep these in a safe place so that the information is available to you at all times.
 - * When lending this tool, for the safety of that person, please include the manual with it.

1) Mounting the guide bar and chain

- Turn the guide bar locking / tensioning knob counterclockwise to loosen the bar (Fig.6).
- Remove sprocket cover (Fig.7).
- Insert the chain tips (teeth) into the groove on the edge of the guide bar (Fig.8a). This is more easily done by laying the guide bar on a flat surface, then laying the chain around it to insert the pins.
- Insert the saw chain and guide bar onto the guide bar holder as shown. Guide the chain around the sprocket (Fig.8b).
- Attach the sprocket cover (Fig.9a) and secure it to the tool by turning the locking / tensioning knob clockwise. Turn it until there is a slight click and stop (Fig.9b.)



Fig. 6



Fig. 7

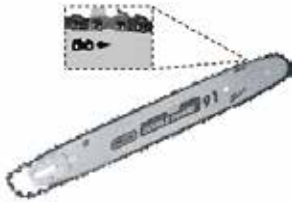

Fig.8a



Fig.8b



Fig.9a



Fig.9b



Do not tighten the locking / tensioning knob until the chain tension has been adjusted.

2) Tensioning the saw chain



WARNING: Always switch off the tool and remove the batteries from the tool before checking and adjusting.

Always wear protective gloves when working on the chainsaw to avoid injury.



WARNING: For safety and to reduce wear, chain tension needs to be verified and adjusted regularly or after 10 minutes of continued use, to compensate for changes in wear and temperature.

- a) To check the tension, pluck the chain anywhere halfway along the bar. The clearance between the underside of the chain and the bar should be $1/8"$ to $5/32"$ / 3-4mm .
- b) If it requires adjusting, turn the locking / tensioning knob counterclockwise one turn to loosen it, then, slowly turn it clockwise until you hear click.

- c) Check its tightness by repeating the test in (a) above.
- d) If too loose, turn the knob clockwise another $\frac{1}{4}$ turn and repeat the test in (a) until the proper gap is attained.

⚠ WARNING: Before installing the bar onto the tool, ensure that all the chain tips lie in the groove along the edge of the edge of the bar.



Fig. 10



Fig. 11

3) Saw chain lubrication

⚠ Always remove the batteries before checking or adjusting and wear gloves to prevent injury.

⚠ To prevent damaging the chain, never operate it without lubricating oil or with it below the low mark. (Fig.12). Chainsaw oil is red in colour to enhance visibility through the oil level window.

⚠ Observe temperature conditions: Different ambient temperatures require lubricants with a very different viscosity. At low temperatures you need thin oils (low viscosity) to produce a sufficient lubricating film. If you use the same oil in summer, it would be liquefied further by the higher temperatures alone. This can cause the lubricating film to break off, overheating the chain and damaging it.

⚠ When the chainsaw is brand new it will take a few minutes for the chainsaw oil to flow from the oil tank to the chain. On subsequent usage, it will work normally.



Fig. 12



Fig. 12b

4) Fill oil tank:

- a) Place the saw on a level surface.
- b) Clean the area around the filler cap and remove it (Fig.12b).
- c) Chain saw oil is recommended as a lubricant.
- d) To prevent blocking the chain oil feeding tip, this operation requires extreme care to prevent the ingress of dirt of any kind.
- e) Remove the cap. Note: to prevent placing it on a dirty surface and/or misplacing it, it is attached to the tool by a string.
- f) Fill the tank with oil to the full mark.
- g) Replace the cap and tighten it.

OPERATION

Considering its potential to cause serious injuries, this short familiarization, without the battery, is recommended.

- 1) Hold the tool from both handles, feeling its weight and balance, by describing imaginary cutting motions.
- 2) Find the trigger On/Off switch. Note, that to prevent accidental starts, this tool is equipment with a switch interlock system. Therefore, press and hold the button on the left side of the handle, before pulling the trigger.
- 3) As an additional safety measure, this saw is equipped with a chain brake/interlock system that disconnects and stops the chain in approximately 0.12 seconds.
- 4) In run mode, the lever/pad in the front, must be in the rear most position.
- 5) Intended or in case of an emergency, pushing it forward, whether or not the trigger has been released, the chain will stop.

Live test

- 1) Install the two batteries.
- 2) Remove the chain guard.
- 3) Hold the tool by both handles (Fig.13).
- 4) Carefully, press the interlock button at the side, followed by the trigger and let the chain accelerate.
- 5) Release the trigger to stop the tool.
- 6) Remove a battery.

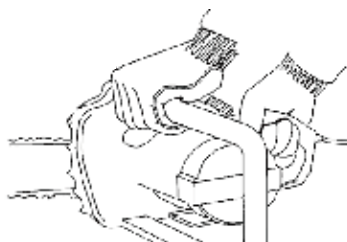
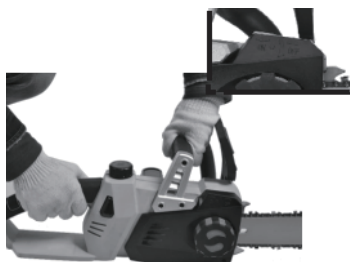

Fig. 13

1. Chain brake

The chain brake is a protective mechanism triggered by the front hand guard. If the chainsaw is thrown back by a kickback, the chain brake is released and stops the saw chain in less than 0.12 seconds.

Check the chain brake function regularly. To do this, engage the hand guard forward and switch on the chainsaw briefly. The saw chain must not start. Pull the front hand guard back until it engages to release the chain brake.



Do not use the saw if the guards do not function properly.
Do not attempt to repair safety guards yourself, but contact our service department or a similarly qualified workshop.

2. Hand protection

The front hand guard (at the same time chain brake) and the rear hand guard protect the fingers against injuries caused by contact with the saw chain if it breaks due to overloading.

3) Working with the chainsaw

1. Preparation

Before each use, check the following points to ensure that you can work safely.

2. Condition of the chainsaw

Before starting work, inspect the chainsaw for damage to the housing, battery, saw chain and bar. Never operate an obviously damaged device.

3. IMPORTANT! Oil Tank

Never operate the chainsaw if there is no oil or the oil level has dropped below the minimum mark (Fig. 12) to avoid damaging the chainsaw. On average, one filling will last for 15 minutes, depending on the pauses and load. You must periodically check the oil level while using the chainsaw to ensure the oil level remains adequate. There is no electric shut off for low gear oil.

4. Saw chain

Tension of the chainsaw and the condition of the cutting edges is very important. The sharper the saw chain, the easier and more controllable the chainsaw can be operated.

The same applies to the chain tension. Check the chain tension every 10 minutes during work to increase your safety! Chains (especially new chains) have the tendency to expand with heat and may become loose on the chainsaw.

5. Chain brake

Check the function of the chain brake as described in the Operation section of the manual and release it.

6. Overload Protection

The chainsaw comes equipped with 2 coloured LED lights on the top of the tool:
Green= Optimal cutting

Red= Overload protection warning. Note the red light will blink 1 or 2 seconds as a warning. Reduce force until green light comes back on. If continued use in red warning mode tool will shut down.

7. Protective clothing

It is essential that you wear the appropriate, tight-fitting protective clothing such as cut-resistant trousers.

8. Hearing protection and safety glasses

Wear a protective helmet with integrated hearing and face protection during felling and forest work.

This provides protection from falling branches.

4) General Use

1. Cutting down a tree (Fig. 14-17)

If two or more persons cut and fell at the same time, the distance between the cutting and cutting persons should be at least twice the height of the tree to be cut. (Fig.14) When felling trees, care must be taken that other persons are not exposed to danger, that no supply lines are hit and that no material damage is caused. If a tree comes into contact with a supply line, the supply company must be informed immediately. When sawing on slopes, the chainsaw operator should be on the ground above the tree to be cut, as the tree is likely to roll or slide downhill after cutting (Fig.15).

Before cutting, an escape route must be planned and, if necessary, cleared.

The escape route must lead diagonally from the expected fall line to the rear, as shown in Fig. 16 (A=danger zone, B = fall direction, C = escape area).

Before felling, the natural inclination of the tree, the position of larger branches and the wind direction must be taken into account in order to assess the fall direction of the tree. Remove dirt, stones, loose bark, nails, staples and wire from the tree.

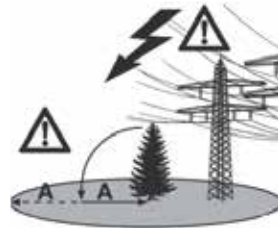

Fig. 14



Fig. 15

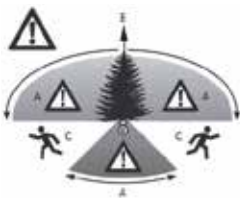

Fig. 16

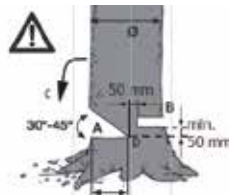

Fig. 17a



Fig. 17b

2. Set notch cut (Fig. 17a)

Saw a notch (A) at right angles to the direction of fall with a depth of $\frac{1}{3}$ of the tree diameter, as shown in Fig. 17a. First make the bottom horizontal notch (A). This will avoid jamming the saw chain or guide bar when setting the second notch.

3. Setting the felling cut (Fig. 17a/17b)

Place the felling cut at least 2" / 50 mm above the horizontal notch cut. Make the felling cut (B) parallel to the horizontal notch cut. Saw the felling cut only deep enough to leave a web (felling bar) (D) which can act as a hinge. The bridge prevents the tree from turning and falling in the wrong direction. Do not saw through the bridge. When the felling cut approaches the bridge, the tree should begin to fall. If it appears that the tree may not fall in the desired fall direction (C) or may tilt back and clamp the saw chain, interrupt the felling cut and use wedges as wood, plastic or aluminum to open the cut and turn the tree to the desired fall line.

When the tree begins to fall, remove the chainsaw from the cut, turn it off, lay it down and leave the danger area via the planned escape route. Watch out for falling branches and do not trip.

4. Delimiting

This is the separation of the branches from the felled tree. When pruning, leave larger branches pointing downwards to support the tree for the time being. Keep smaller branches away from the ground as shown in Fig. 18 (A=Direction of cut when pruning, B=Distance from ground).

Leave supporting branches until the trunk is sawn with a cut. Branches that are under tension should be sawn from bottom to top to avoid jamming the saw.

5. Cut tree trunk to length

This means dividing the felled tree into sections. Make sure that you stand securely and that your body weight is evenly distributed on both feet. If possible, the trunk should be supported by branches, beams or wedges. Follow the simple instructions for light sawing. When the entire length of the log is evenly supported, as shown in Fig. 19, saw from above. Be careful not to cut into the ground.

If the log is resting on one end, as shown in Fig. 20, first saw $\frac{1}{3}$ of the log diameter from the bottom (A) to avoid splintering. Make the second cut from above ($\frac{2}{3}$ diameter) at the level of the first cut (B) (to avoid jamming). When the log rests on both ends, as shown in Fig. 21, first saw $\frac{1}{3}$ of the log diameter from the top to avoid splintering (A). Make the second cut from below ($\frac{2}{3}$ diameter) at the level of the first cut (B) (to avoid jamming).



Fig. 18



Fig. 19

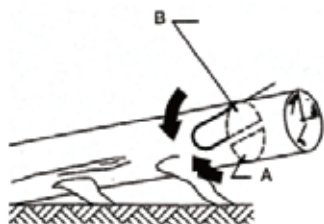

Fig. 20

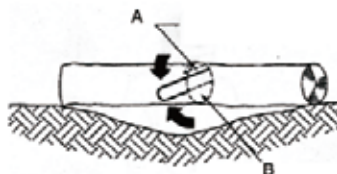

Fig. 21

When sawing on slopes, always stand above the tree trunk, as shown in Figure 15. To maintain full control at the moment of sawing, reduce the contact pressure towards the end of the cut without loosening the firm grip on the handles of the chainsaw. Make sure that the saw chain does not touch the ground. When the cut is complete, wait for the saw chain to stop before removing the chainsaw. Always switch off the chainsaw motor before changing from tree to tree.

6. Kickback

Kickback is the sudden up and backstroke of the running chainsaw. The causes are usually touching the workpiece with the tip of the guide bar or jamming the saw chain. Particularly with lateral cuts, inclined cuts and longitudinal cuts, the danger of kickback is particularly great because the claw stop cannot be used. Avoid such cuts as much as possible and work carefully if they cannot be avoided!

The danger of kickback is greatest if you place the saw in the area of the tip of the bar, because this is where the leverage is strongest (Fig. 22). Always place the saw flat and close to the claw (Fig. 23).

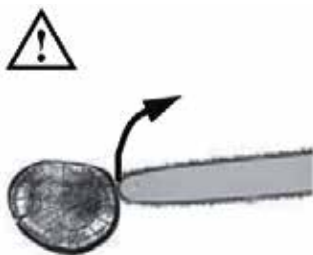

Fig. 22

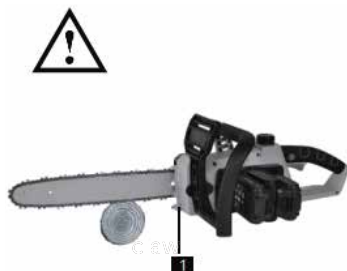

Fig. 23

- !** Always pay attention to the correct chain tension!
 Only use a chainsaw that is in proper working order and is not damaged.
 Only work with a saw chain that has been properly sharpened!
 Never saw over shoulder height!
 Never saw with the top edge or tip of the bar!
 Always hold the chainsaw firmly with both hands!
 If possible, always use the claw stop as a lever.

7. Sawing of wood under tension

Sawing wood that is under tension requires special care! Wood under tension, which is released from tension by sawing, sometimes reacts completely uncontrolled.

This can lead to serious or even fatal injuries (Fig. 24-26).
 Such work may only be carried out by trained specialists.

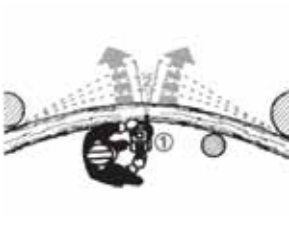

Fig. 24

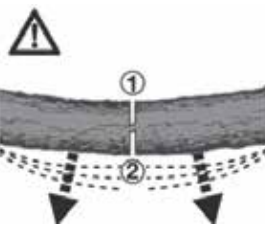

Fig. 25

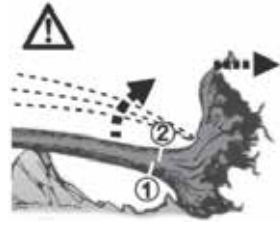

Fig. 26

MAINTENANCE

1. Replace saw chain and guide bar

The guide bar must be replaced when the guide groove of the guide bar is worn out. The spur gear on the bar is damaged or worn.

Proceed as described in "Mounting the guide bar and saw chain"!

- a) Checking the automatic chain lubrication.
- b) Regularly check the function of the automatic chain lubrication to prevent overheating and associated damage to the bar and saw chain. To do this, point the tip of the bar against a smooth surface (board, pruning a tree) and let the chainsaw run.

If there is an increasing trace of oil during this process, the automatic chain lubrication works perfectly.

2. Sharpening the saw chain

Effective work with the chainsaw is only possible if the saw chain is in good condition and sharp.

This also reduces the risk of kickback.

The saw chain can be resharpened by any specialist dealer. Do not try to sharpen the saw chain yourself if you do not have a suitable tool and the necessary experience.

3. Cleaning and storage

- a) Clean the clamping mechanism regularly by blowing it out with compressed air or cleaning it with a brush.
- b) Do not use tools for cleaning.
- c) Keep the handles oil-free to ensure a secure grip.
- d) If necessary, clean the appliance with a damp cloth and, if necessary, with a mild detergent.
- e) If the chainsaw will not be used for a long period of time, remove the chain oil from the tank.

Place the saw chain and the bar briefly in an oil bath and then wrap them in oiled paper.



Before each cleaning, switch off the device and pull out the battery. Never immerse the device in water or other liquids for cleaning. Keep the chainsaw in a safe and dry place and out of the reach of children.

4. Information on environmental protection & disposal



Once the device has become unusable, ensure that it is disposed of properly. Do not dispose of the device with household waste, but hand it over to a collection point for electrical appliances in the interests of environmental protection. Your local authority will be happy to inform you about addresses and opening hours.

EXPLODED VIEW

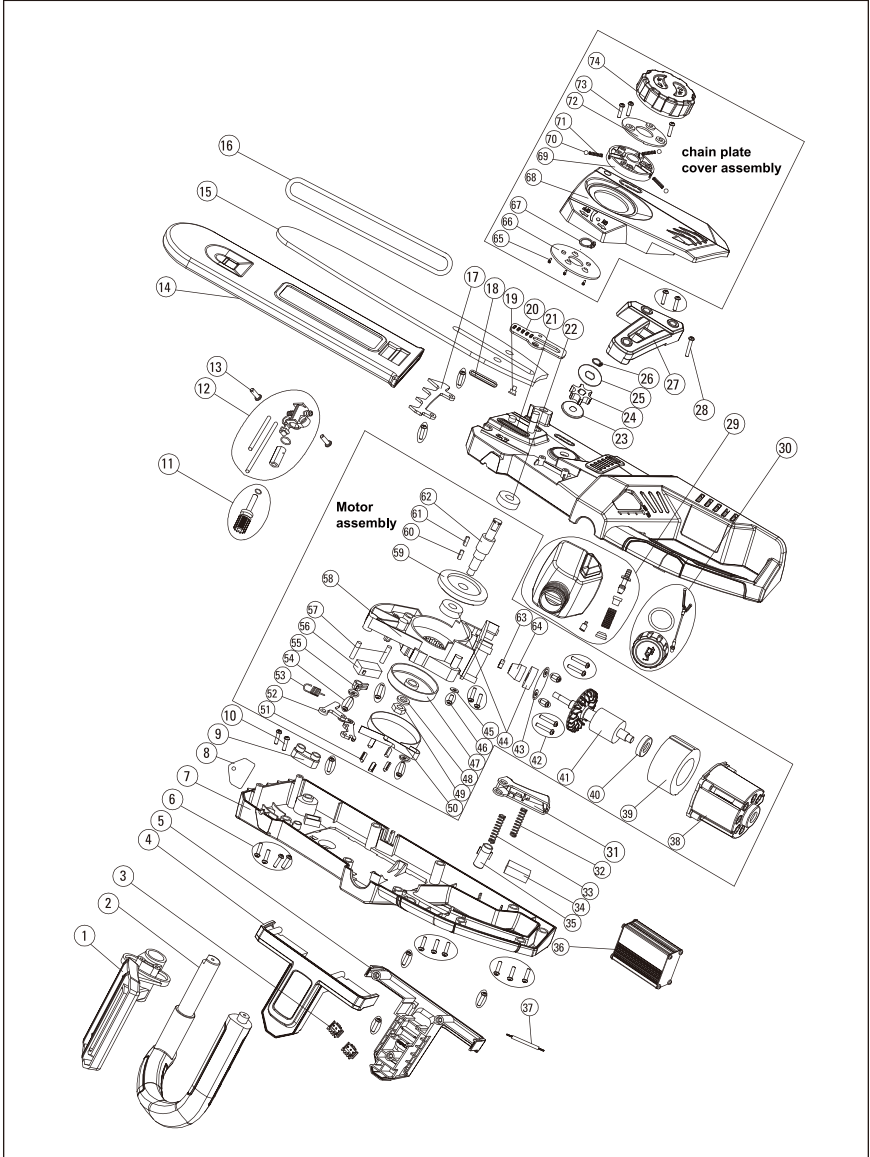

PARTS LIST

⚠ WARNING: When servicing, use only original equipment replacement parts. The use of any other parts may create a safety hazard or cause damage to the brushless chainsaw.

Any attempt to repair or replace electrical parts on this brushless chainsaw may create a safety hazard unless repairs are performed by a qualified technician. For more information, call the Toll-free Helpline, at 1-866-349-8665 – Monday-Friday from 9am - 5pm Eastern Standard Time.

Always order by PART NUMBER, not by key number.

Key #	Part #	Part Name	Quantity
1	8053-22910201	Hand guard	1
2	8094-22910101	Front grip	1
3	8049-18920101	Terminal block	2
4	8039-18920101	Battery upper frame	1
5	8039-18920201	Battery lower frame	1
6	8SBAQA04-16	Screw	18
7	8001-22940101	Left housing	1
8	8113-22910401	Indicator label	1
9	8072-141003	Brake dial block	1
10	8SBAQA04-16	Screw	2
11	8160-940002	Oil pump core assembly	1
11-1	8146-940002	Oil pump core	1
11-2	8052-900003	Oil pump teeth	1
11-3	8138-940005	Oil pump pin	1
11-4	8025-900003	O-ring	1
12	8160-22910101	Oil pump shell assembly	1
12-1	8146-141001	Oil pump shell	1
12-2	8023-900003	Oil pump sleeve	1
12-3	8028-900001	Rubber washer	1
12-4	8038-920002	Oil line	1
12-5	8038-22910101	Oil line	1
13	8SBAQA04-12	Screw	2
14	8023-900004	Guard	1
15	144MLEA041	Chain plate	1
16	90PX052X	Saw chain	1
17	8155-229101	Kick back control	1
18	8025-900004	Rubber ring	1
19	8009-401001	Rivet	1
20	8053-401004	Adjusting plate	1
21	8002-22940101	Right housing	1

Key #	Part #	Part Name	Quantity
22	8DB-600002	Bearing	1
23	8069-900001	Anti-dust cover	1
24	8155-950001	Sprocket	1
25	8030-141003	Washer 2	1
26	8CC-10	Snap spring	1
27	8039-22910401	Front grip support	16
28	8SBAQA04-20	Screw	4
29	8160-19910201	Oil tank assembly	1
29-1	8147-22910101	Oil tank	1
29-2	3122920101148001	Oil tank rubber nozzle	1
29-3	8148-900001	Oil tank nozzle	1
29-4	8025-900001	Sealing ring	1
29-5	8060-900005	Spring	2
29-6	8081-900001	Filter block	1
30	8160-131001	Oil tank cover assembly	24
30-1	8069-131001	Oil tank cover	1
30-2	8025-900002	O-ring	1
30-3	3122920101161001	Oil tank cover chain	1
31	8157-22910101	Trigger	1
32	8060-22710301	Spring	1
33	8060-22910101	Spring 1	1
34	8032-227101	Micro switch	1
35	8058-22910201	Power module	1
36	8092-01910101	Power module	1
37	8027-17820101	Inner wire 1	1

MOTOR ASSEMBLY			
Key #	Part #	Part Name	Quantity
38	8049-22940101	Motor seat	1
39	8005-22940101	Stator	1
40	8DB-60802	Bearing	1
41	8013-22940101	Rotor	1
42	8SBABC04-25	Screw	4
43	8030-900003	Washer 3	4
44	8DB-600002	Bearing	2
45	8030-920001	Washer	1
46	8SBAQA04-12	Screw	3
47	8031-401001	Brake wheel	1
48	8WSB-08	Spring	1
49	8NAB-08	Nut	1
50	8047-141001	Brake band	1

Key #	Part #	Part Name	Quantity
51	8156-900002	Bakelite	5
52	8050-141001	Hinge	1
53	8060-960002	Tension spring	1
54	8SBABC04-16	Screw	5
55	8072-22910101	Dial block	1
56	8032-227101	Micro switch	1
57	8138-900003	Pin	2
58	8039-229101	Motor frame	1
59	8052-22910201	Main gear	1
60	8077-22910101	Flat key	1
61	8077-22910201	Flat key	1
62	8020-22910101	Output shaft	1
63	8NDD-06	Self locking nut	1
64	8052-22910101	Pinion	1

CHAIN PLATE COVER ASSEMBLY			
Key #	Part #	Part Name	Quantity
65	8SEADA04-12	Screw	3
66	8053-900002	Thread plate	1
67	8CC-14	Snap spring	1
68	8069-22910101	Chain plate cover	1
69	8058-401001	Turn button 1	1
70	8128-401001	Steel ball	3
71	8060-401001	Spring	3
72	8053-401001	Turn button plate	1
73	8SBAQA04-8	Screw	3
74	8058-22910101	Turn button	1

WARRANTY

RADLEY 40V MAX BRUSHLESS CHAINSAW WARRANTY

If this Radley Tool fails due to a defect in material or workmanship within three years from the date of purchase, return it to any Home Hardware store with the original bill of sale for exchange. Two years for battery and charger. This warranty does not include expendable parts including but not limited to blades, brushes, belts and light bulbs. This warranty covers defects in material or workmanship only. It does not cover normal wear and tear, failure due to abuse/misuse, or defects caused by careless or accidental mishandling. If this Radley product is used for commercial or rental purposes, this warranty does not apply.

40V Max* Chainsaw

Oregon® 14" Bar



Brushless motor
technology

Includes 2 batteries
and 1 charger

3 Year
limited warranty



Radley®

EXCLUSIVE TO HOME HARDWARE

For information on the entire line-up of Radley power
tools visit homehardware.ca or your local Home Hardware retail store.

MADE IN CHINA / FABRIQUÉ EN CHINE
HOME HARDWARE STORES LIMITED
ST. JACOBS, ONTARIO N0B 2N0
ORDER ONLINE / COMMANDE EN LIGNE
homehardware.ca

© 06 / 2020 Home Hardware Stores Limited



5240-044