

BENCHMARKTM MC

20V MAX BRUSHLESS AXIAL FAN BLOWER



Kit includes 1 battery & 1 charger
5 Year Limited Warranty on tool
3 Year Limited Warranty on battery and charger



800874
GY218101

**READ ALL INSTRUCTIONS BEFORE FIRST USE.
KEEP THIS MANUAL FOR FUTURE REFERENCE.
KEEP AWAY FROM CHILDREN.**

Maximum initial battery voltage (measured without a load)
is 20 volts. Nominal voltage is 18 volts.



**WEAR CSA APPROVED
EYE PROTECTION**



**WEAR EAR
PROTECTION**



**WEAR A
FACE MASK**

PRODUCT SPECIFICATIONS

AXIAL FAN BLOWER

Air Speed	112 MPH
Turbo	21500 RPM
Air volume	330 CFM
Weight	3.33 lbs (1.51 kg)

BATTERY AND CHARGER

Battery voltage	20 V Max add 4Ah Li-ion (Maximum charged battery voltage, measured without load, is 20V with a nominal value of 18V)
Charger	Up to 120 minutes
Replacement battery	5350-011
Replacement charger	5350-010

NEED ASSISTANCE?

Call us on our toll-free customer support line:
1-866-349-8665 (Monday through Friday 9am – 5pm Eastern Standard Time)

- Technical questions
- Replacement parts
- Parts missing from package

TABLE OF CONTENTS

Product Specifications 1

Table of Contents 2

General Safety Warnings 3

Electric Gardening Tool Safety 5

Specific Safety Rules 7

Service 10

Battery Pack Recycling 10

Symbols 11

Know Your Brushless Axial Fan Blower 12

Checking the Battery Charger Status 13

Assembly and Operation 13

Operating the Brushless Axial Fan Blower 17

Maintenance 17

Storage 17

Exploded View 18

Parts List 19

Warranty 20







GENERAL SAFETY WARNINGS



IMPORTANT SAFETY INSTRUCTIONS

Read and understand all safety and operational instructions. Failure to follow the safety rules listed below and other basic safety precautions may result in serious personal injury. Keep this manual, sales receipts and applicable warranty forms for future reference.

SAFETY SYMBOLS

The purpose of safety symbols is to alert you of the potential safety RISKS. Recognize and understand them. Follow the instructions provided.

SYMBOL	MEANING
	Failure to obey a DANGER safety alert WILL result in serious personal injury or death to you or to others. Always obey all messages following this symbol to reduce the risk of serious personal injury or death.
	Failure to obey a WARNING safety alert MAY result in serious personal injury or death to you or to others. Always obey all messages following this symbol to reduce the risk of potential serious personal injury or death.
	Failure to obey a CAUTION safety alert MAY result in personal injury or property damage to you or to others. Always obey all messages following this symbol to reduce the risk of personal injury or property damage.
	Failure to obey a NOTICE or a CAUTION (without a safety alert) MAY result in property damage to you or to others. Always obey all messages following this symbol to reduce the risk of property damage.
	ALWAYS WEAR EYE PROTECTION THAT CONFORMS WITH CSA Z94.3 or ANSI SAFETY STANDARD Z87.1 FLYING DEBRIS can cause permanent eye damage. Prescription eyeglasses ARE NOT a replacement for proper eye protection. The usage of a safety standard compliant face shield placed over proper safety glasses or goggles can reduce the risk of facial injury. Non-compliant eyewear can cause serious injury if broken during the operation of a power tool.
	Use hearing protection, particularly during extended periods of operation of the tool, or if the operation is noisy.
	WEAR A DUST MASK THAT IS DESIGNED TO BE USED WHEN OPERATING A POWER TOOL IN A DUSTY ENVIRONMENT. Refer to Page 7 of this manual for California Prop 65 warnings relating to hazardous dust particles.

SYMBOL	MEANING
<p>⚠ WARNING</p> 	<p>Always wear non-slip gloves that fit properly to protect your hands and to help you grip the tool.</p> <p>Always wear sturdy clothing with long sleeves and long pants. Never operate the tool while wearing shorts, short sleeve shirt or while shirtless.</p> <p>Always wear non-slip safety boots to prevent foot injuries and slipping that could cause loss of control of the tool.</p>
<p>⚠ WARNING</p> 	<p>To avoid electrical hazards, fire hazards or damage to the tool, use proper circuit protection.</p> <p>This tool is wired at the factory for 120 V AC operations. It must be connected to a 120 V AC, 15 A circuit that is protected by a time-delayed fuse or circuit breaker. To avoid shock or fire, replace power cord immediately if it is worn, cut or damaged in any way.</p>
<p>⚠ WARNING</p> 	<p>WARNING: Ventilation openings in batteries and chargers must always be open to allow cooling air to circulate freely. Air vents that are blocked, restricted or covered may result in the battery or charger overheating. Overheating may lead to damage to the tool or cause a fire, resulting in possible serious injury.</p>

ELECTRIC GARDENING TOOL SAFETY

GENERAL SAFETY WARNINGS

 **WARNING: Read all safety warnings and all instructions.** Failure to follow the warnings and instructions may result in electric shock, fire and/or serious injury.

Save all warnings and instructions for future reference.

General Electric Gardening Tool Safety Warnings – Work Area Safety

Do not operate power tools in explosive atmospheres, such as in the presence of flammable liquids, gases or dust. Power tools create sparks which may ignite the liquids, fumes or dust.

Keep children and bystanders away while operating a power tool.

Distractions can cause you to lose control.

GENERAL ELECTRIC GARDENING TOOL SAFETY WARNINGS

– ELECTRICAL SAFETY

Battery charger plugs must match the outlet. Never modify the plug in any way. Do not use any adapter plugs with earthed (grounded) chargers. Unmodified plugs and matching outlets will reduce risk of electric shock.

Avoid body contact with earthed or grounded surfaces such as water pipes. There is an increased risk of electrical shock if your body is earthed or grounded.

Do not expose power tools, battery chargers or batteries to rain or wet conditions. Water entering the tool, chargers or batteries will increase the risk of electric shock.

Do not abuse the cord. Never use the power cord for carrying, pulling or unplugging the charger. Keep the power cord away from heat, oil, sharp edges, and moving parts. Damaged or entangled cords increase the risk of electric shock.

When operating the charger outdoors, use an extension cord suitable for outdoor use. Use of a cord suitable for outdoor use reduces the risk of electric shock.

Never operate a power tool in the rain.

If operating a charger in a damp location is unavoidable, use a residual current device (RCD) protected supply. An RCD is also known as a ground fault circuit interrupter (GFCI) or earth leakage circuit breaker (ELCB). Use of an RCD reduces the risk of electric shock.

GENERAL ELECTRIC GARDENING TOOL SAFETY WARNINGS

– PERSONAL SAFETY

Stay alert, be aware of your surroundings, watch what you are doing and use common sense when operating a power tool. Do not use a power tool while you are tired or under the influence of drugs, alcohol, or medication. A moment of inattention while operating a power tool may result in serious personal injury.

Use personal protective equipment. Always wear eye protection. Protective equipment such as dust mask, non-skid safety shoes or boots, sturdy gloves, durable long pants, long sleeve shirt and hearing protection will reduce the risk of personal injuries.

Prevent unintentional starting. Ensure the switches are in the off position before connecting the battery to the power tool or plugging it into the power supply. Never pick up or carry the power tool with your finger on the trigger switch. Carrying power tools with your finger on the switch or energizing power tools that have the switch on invites accidents.

Remove any adjustment key or wrench before turning the power tool on.

A wrench or a key left attached to a rotating part of the power tool may result in personal injury.

Do not overreach. Keep proper footing and balance at all times.

This enables better control of the power tool in unexpected situations.

Dress properly. Do not wear loose clothing or jewellery. Keep your hair, clothing and gloves away from moving parts. Loose clothing, jewellery or long hair can be caught in moving parts.

Do not force the tool. Use the correct tool for the application. The correct power tool will do the job better and safer when used at the rate for which it was designed.

Do not use a power tool if the switch does not turn it on or off. Any power tool that cannot be controlled using the switch is dangerous and must be repaired.

Remove the battery from the power tool or the plug from the power source before making any adjustments, replacing or repairing parts, cleaning the tool, leaving the tool idle or unattended, transporting or storing the tool. Such preventive safety measures reduce the risk of starting the power tool accidentally.

Store idle power tools out of the reach of children and do not allow persons unfamiliar with the power tool or these instructions to operate the power tool. Power tools are dangerous in the hands of untrained users.

Maintain power tools. Check for misalignment or binding of moving parts, breakage of parts and any other condition that may affect the power tool's operation. If damaged, have the power tool repaired before use.

Many accidents are caused by poorly maintained power tools

Use the power tool and accessories in accordance with these instructions, taking into account the working conditions and the work to be performed.

Use of the power tool for operations different from those intended could result in a hazardous situation.

SPECIFIC SAFETY RULES

 **WARNING:** This product contains chemicals known to the State of California to cause cancer and birth defects or other reproductive harm.

 **WARNING:** Some dust created by power sanding, sawing, grinding, drilling, and other construction activities contain chemicals known to cause cancer, birth defects, or other reproductive harm. Some samples of these chemicals are:

- lead from lead-based paints,
- crystalline silica from bricks and cement and other masonry products, and
- arsenic and chromium from chemically treated lumber.

Your risk from these exposures varies, depending on how often you do this type of work. To reduce your exposure to these chemicals: work in a well-ventilated area, and work with approved safety equipment, such as those dust masks that are specially designed to filter out microscopic particles.



 **WARNING:** Know your blower. Do not plug in the charger or install the battery onto the tool until you have read and understand this Instruction Manual. Learn the tool's applications and limitations, as well as the general and specific potential hazards related to this tool. Following these instructions will reduce the risk of electric shock, fire or serious injury.



 **WARNING:** Always wear appropriate eye protection. Any power tool can throw foreign objects into your eyes and cause permanent eye damage. ALWAYS wear appropriate safety goggles or properly fitted safety glasses that comply with the most recent version of ANSI Z87.1 safety standards. Ordinary vision or sunglasses generally do not provide adequate impact or side shield / wrap around penetration protection. Ordinary glasses ARE NOT safety glasses. To reduce the risk of injury to your face you should also wear a face shield over your safety goggles or safety glasses.



 **WARNING:** Glasses, goggles or face shields not in compliance with ANSI Z87.1 or CAN/CSA – Z94.3 could cause serious injury if they break upon impact.



 **WARNING:** Use hearing protection. Use hearing protection such as ear plugs or ear muffers to protect your hearing, particularly if the blower is used for extensive periods or if the surrounding environment of operation exposes the operator to loud noises. When wearing hearing protection, you will have impaired ability to hear alarms, warnings and shouts from approaching people or approaching vehicles. Be extra diligent and observant of hazards and bystanders when wearing hearing protection devices. When someone approaches, turn the blower OFF immediately.

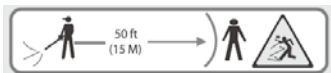



! WARNING: The high velocity of the air flow coming through the nozzle will throw objects and debris violently. These objects and debris will ricochet in all directions. You or bystanders can be blinded or injured. Keep children, bystanders, pets and other animals at least 50 feet (15 meters) away from the operating blower. Turn the blower OFF immediately if approached, or if you are approaching such bystanders. Bystanders should be encouraged to wear eye protection, even if they are kept at a distance.

Thrown objects may also ricochet and strike the operator or bystander.

Utilize extra caution, when the blower is being used near, or on paved or hard surfaces, as pieces of metal, concrete, brick, stones, gravel, sand, glass, sticks and other objects can be thrown at high speed and force and such objects can be thrown, skip along or ricochet long distances off of hard surfaces.

Do not use this blower for sweeping debris that may contain hard objects, e.g. pebbles, stones, sticks, glass, metal, etc. as such hard objects can be thrown with great force and cause injury to the operator or bystanders, and / or damage property, e.g., screens, windows, building siding, glass doors, or vehicles.

Avoid operating the blower near property that can be easily damaged by thrown or ricocheting objects such as screens, windows, building siding, glass doors and vehicles.



! WARNING: Always wear breathing protection when operating the blower. Bystanders should be encouraged to wear breathing protection devices even if they are kept at a distance as hazardous dust can travel considerable distances, especially if the dust is wind-blown.



! WARNING: Know what you are going to blow before you blow.

! WARNING: Inspect the area to be cleared for hazards before each use. Remove any foreign objects such as sticks, rocks, broken glass, nails, wire, tools, toys, etc. which can be thrown by the blower.

! WARNING: If you are suspicious or uncertain if the material that you are considering blowing would cause hazardous dusts, first, identify and investigate the nature of the materials.

If the materials have the potential to be hazardous, do not use the blower, instead, utilize other safe clean up procedures and disposal procedures. If you are suspicious that you have been blowing or come into contact with asbestos, or crystalline silica materials or hazardous chemical or biological materials, contact your doctor, your employer if your use of the blower is job related, and the local EPA or OSHA representative immediately. Clean up and dispose of hazardous chemicals and substances prior to using the blower, using appropriate clean up procedures, personal protective equipment, and disposal methods.

⚠️ WARNING: Dust created by use of this product may contain chemicals known to the State of California and medical experts to cause cancer, respiratory injuries, birth defects or other reproductive harm. Some examples of these chemicals are:

- Compounds in fertilizers
- Compounds in insecticides, herbicides and pesticides
- Arsenic and chromium from chemically treated lumber
- Commercial and household chemicals.

To reduce your exposure to these chemicals, wear approved safety equipment such as dust and / or vapor masks that are specifically designed to filter out microscopic particles or gaseous components. Additionally, dust created by these products may contain allergens, bacteria and viruses, PM 10 and / or PM 2.5 particulates, exposure to such hazardous airborne matter can be reduced by wearing approved safety equipment such as dust masks that are specifically designed to filter out the microscopic particles.

⚠️ WARNING: Breathing asbestos or dust with silica in its composition may contain hazardous crystalline silica. Silica is a fundamental component of sand, quartz, brick, clays, granite and many other materials and rocks, including masonry, concrete and cement products. Such crystalline silica dust is dangerous and must be avoided, as it can cause severe or fatal respiratory illness or cancer.

⚠️ WARNING: Avoid blowing near open windows or doors, or anywhere near bystanders or animals as doing such may cause exposure to the potentially hazardous dust, particularly down-wind of your blowing operation due to the respiratory hazard reasons stated above.

Do not work against the wind as the dust will blow back towards the operator increasing the exposure to the dust.

Keep the blower below waist level and point the blower nozzle below waist level.



⚠️ WARNING: Check the air intake screen before each use to make sure it is in good condition. If any damage is identified, replace the part immediately before using the blower. A damaged air intake screen will cause your fingers to be injured by the fan.

⚠️ WARNING: Never operate the blower without the nozzle and the intake fan screen in place. Serious injury or damage to the blower may result.

⚠️ WARNING: Never insert a foreign object such as a screwdriver, stick, etc. into the nozzle, air exhaust tube or the intake fan screen. Any foreign article that becomes lodged in the air system may be ejected at great speed causing serious injury when the blower is turned ON. It may also severely damage the blower fan.

⚠️ WARNING: Always remove the battery when making adjustments, changing the nozzle, removing debris from the air intake screen, leaving the tool idle or unattended, cleaning, servicing, storing or transporting the tool. Such preventive measures reduce the risk of starting the tool accidentally and causing serious injury.

⚠️ WARNING: Never modify the blower in any way. It is designed to be used only with the nozzle and power cell that are supplied with the tool. The use of any other accessory or modifying the tool may create a safety hazard. This action will also void the warranty.

Never use the blower without the nozzle properly installed. This will allow you to direct the air flow where you want it and make the tool more efficient.

Always keep the handles clean. Handles that are covered with grease, chemicals or debris will make holding onto the blower difficult. Use a clean cloth dampened with soapy water to clean these surfaces.

Never use a pressure washer, garden hose or any other liquid or chemical solvents to clean the blower.

⚠️ WARNING: When blowing very dusty materials in extremely dry conditions for long periods of time, static electricity may build up and discharge without warning. To avoid this situation in dry dusty conditions, only operate the blower for short periods of time and turning the blower OFF at regular intervals.

Maintain firm footing and balance at all times. Do not overreach or use the blower from unstable surfaces such as ladders, trees, steep slopes, slippery surfaces, rooftops, etc.

Always grasp the blower using the handles on the machine.

Use only in daylight or in good quality artificial light.

Never use the blower for anything other than its intended purpose. Use for anything other than blowing leaves, grass, weeds or lawn debris can be dangerous. It may also damage the blower.

SERVICE

Have your power tool serviced by a qualified repair person using only identical replacement parts. This will ensure that the safety of the power tool is maintained.

















BATTERY PACK RECYCLING



To preserve our natural resources, please recycle or dispose of batteries properly. The batteries charged by this charger may contain chemicals and metals that are harmful to the environment. Never dispose of rechargeable batteries in your normal household garbage or in landfill sites as they will add to the pollution of the environment.

SYMBOLS

The rating plate on your tool may show symbols. These represent important information about the product or instructions on its use.

	Conforms to relevant safety standards.		Waste electrical products should not be disposed of with household waste. Please recycle where facilities exist. Check with your Local Authority or retailer for recycling advice.
	Read the instruction manual.		
	Thrown objects can ricochet and result in personal injury or property damage.		Caution: Wear protective gloves when using the machine and handling debris.
	For protection against injury wear ear defenders and safety goggles.		Caution: Wear safety boots
	Keep bystanders and pets clear of the machine when in use.		Do not expose the machine to rain. Store the machine in a dry place.
	Warning!		130 °C Thermal link with operating temperature
	Contains Lithium ion		Warning. Moving blades. Keep hands and feet away when the machine is operated.
	Dress properly, do not wear loose clothing or jewellery that could be drawn into the air intake		
	Remove battery from machine before maintenance, adjusting, or cleaning		



This symbol designates that this tool is listed with Canadian and U.S. requirements by cSGSUS Testing Laboratories, Inc.
UL1017 CSA C22.2 No.243-17

KNOW YOUR AXIAL FAN BLOWER

- 1. Axial fan blower tube
- 2. Axial fan blower outlet
- 3. On/Off variable speed switch
- 4. Turbo speed button
- 5. Handle
- 6. Air Intake

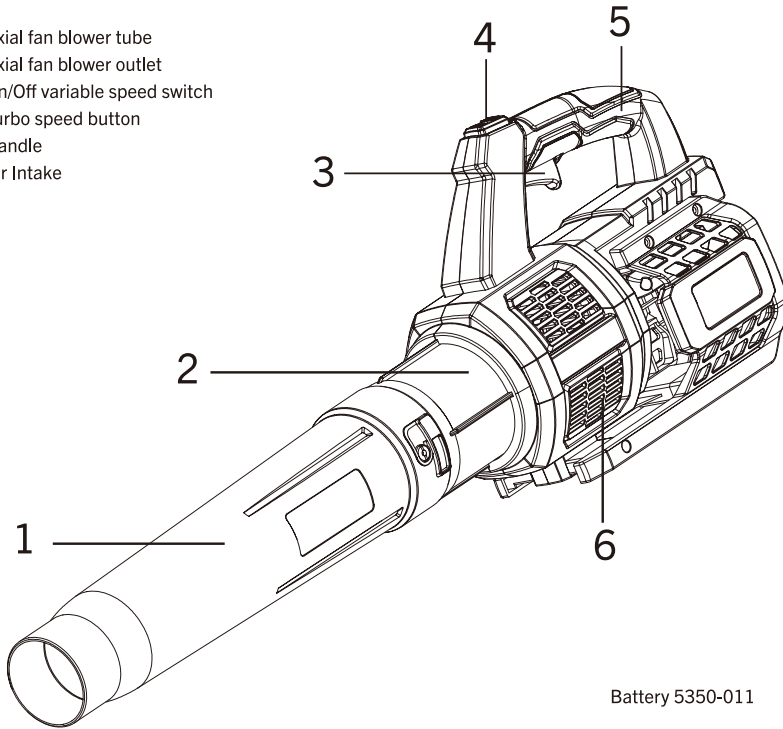

Battery 5350-011



Battery Charger 5350-010







CHECKING THE BATTERY CHARGER STATUS

The level of charge remaining in the battery can be checked by using the battery LED power indicator that is contained on the end of the battery.

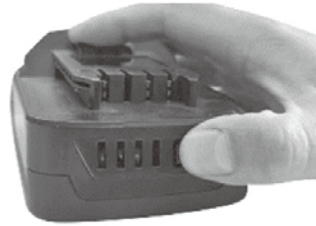
NOTE: The battery charge remaining may be checked while the battery is installed in the tool with the ON/OFF switch turned OFF. It may also be checked while the battery is removed from the tool. **DO NOT** check the battery charge remaining while the battery is in the charger. You will get a false reading and you may also damage the battery status system.

1. Press and hold the battery status button located on the end of the battery
2. One or more of the Four LED lights in the LED window will come ON to indicate the amount of charge that is remaining in the battery as follows:



Charge level indicator				
Amount of charge remaining	10-25%	25-50%	50-75%	75-100%

3. Release the battery status button to turn the LEDs OFF.

ASSEMBLY AND OPERATION

CHARGING THE BATTERY PACK

1. Place the battery charger (1) in a dry location near a 110–120V 60 Hz electrical outlet (Fig. 2).
2. Plug the battery charger into the outlet and make sure the green LED indicator light (5) comes ON. If it does not, refer to the chart (Fig. 3) to identify the problem.
3. Turn the battery (2) upside down and slide it onto the charger.

NOTE: Make sure the grooves (3) in the sides of the battery slide over the matching tabs on the charger (4) until the battery latch “clicks” into place.

NOTES:

1. When the charger is plugged into the wall receptacle and NO battery is on the charger, the green indicator light (5) will turn ON indicating the charger is “live”.
2. When a discharged battery is installed on the charger, the green indicator light will turn OFF and the red indicator light (6) will turn ON. The red indicator light indicates the battery is being charged.
3. If the red indicator light does not come ON, check to make sure battery pack is slid fully onto the charger and the electrical outlet is working properly.
4. See Fig. 3 below for other indicator light functions.
5. A discharged battery pack should be fully charged in approximately 2 hrs.

6. It is normal for the battery charger to hum and be warm to the touch during operation.
7. If the battery pack does not charge properly, check to make sure the electrical outlet is “live”.
8. Do NOT charge batteries when the work area or the battery temperature is at or below 5°C / 41°F or above 40.5°C / 105°F.



FIG. 2

GREEN LIGHT	RED LIGHT	BATTERY INSERTED INTO CHARGER	CHARGING STATUS
ON	OFF	NO	Charger connected to power supply
OFF	Blink	YES	Battery being charged
ON	OFF	YES	Battery fully charged
OFF	ON	YES	Battery is charged but not operational on tool. This may indicate defective / bad contact on battery.
ON	ON	YES	Charging conditions are either too hot or too cold

FIG. 3

INSTALLING A BATTERY ON THE BRUSHLESS AXIAL FAN BLOWER

1. Remove the discharged battery (1) from the brushless axial fan blower by pressing downward on the battery release button (2) and sliding the battery backward until it is removed from the brushless axial fan blower port (3) (Fig. 4).
2. Slide the fully charged battery onto the matching keys (4) in the brushless axial fan blower port (3) where the discharged battery has been removed.

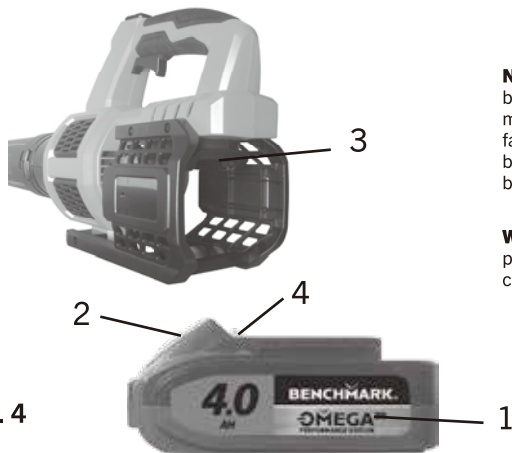

FIG. 4

NOTE: Make sure the slots in the battery are fully engaged with the mounting keys in the brushless axial fan blower port (3). The battery release button will “click” into place when the battery is fully installed.

WARNING: Do not immerse the battery pack in water. Sudden cooling could cause a hot battery to explode or leak.

PACKAGING CONTENTS

- Axial fan blower
- Blower tube
- 20v lithium ion battery & Charger
- Concentrator nozzle
- Operator's manual

⚠ WARNING: If any parts are damaged or missing, do not operate this product until the parts are replaced. Use of this product with damaged or missing parts could result in serious personal injury.

⚠ WARNING: Do not install the batteries until assembly is complete. Failure to comply could result in accidental starting and possible serious personal injury.

⚠ WARNING: Do not attempt to modify this product or create accessories not recommended for use with this product. Any such alteration or modification is misuse and could result in a hazardous condition leading to possible serious personal injury.

REMOVING BATTERY PACK

⚠ WARNING: Always remove the battery packs from your tool when you are assembling parts, making adjustments, cleaning, carrying, transporting or when not in use. Removing the battery packs will prevent accidental starting that could cause serious personal injury.

Slide a battery pack into the slots until it clicks into place, Fig. 5. (Note the battery has raised ribs which allows it to fit into the machine only one way.)

To remove the battery, press the battery release button, and pull the battery pack out of the slot, Fig. 6.



FIG. 5



FIG. 6

ATTACHING THE BRUSHLESS AXIAL FAN BLOWER TUBE

Align the widest end of the brushless axial fan blower tube with the front opening on the brushless axial fan blower outlet. Slide the brushless axial fan blower tube over brushless axial fan blower outlet, lining up the brushless axial fan blower tube slot (7.1) with the brushless axial fan blower outlet tab (7.2).

Rotate and Slide the brushless axial fan blower tube over blower outlet, tube and turn clockwise to lock into place, Fig. 8.

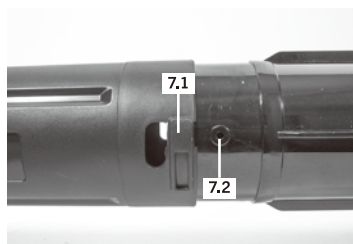

FIG. 7

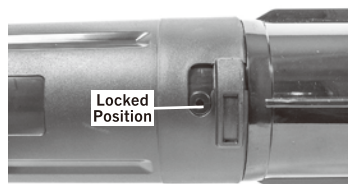

FIG. 8

OPERATION

⚠ WARNING: TO AVOID SERIOUS INJURY AND PROPERTY DAMAGE:

Inspect the area before using the brushless axial fan blower.
Remove all hard objects from work area.

Do not blow debris in the direction of people, animals or property.

STARTING/STOPPING THE BRUSHLESS AXIAL FAN BLOWER

Hold the brushless axial fan blower with your preferred hand, with the tube several inches off the ground.

Press and hold the variable speed ON/OFF switch (9.1) to start the Brushless axial fan blower. Please note this switch also controls the variable speed, which means the further you push the switch the more air speed you will achieve. The less you push, the less airspeed.

Release to stop the blower.

Press and hold the TURBO speed button (9.2) to maximize air speed while pressing the variable On/Off switch. Release the TURBO button to resume normal air speed.

IMPORTANT: Use of the turbo function will drain the battery quicker resulting in less run time.

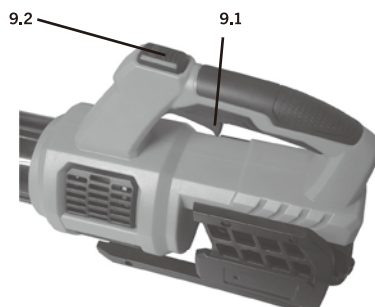

FIG. 9

OPERATING THE BRUSHLESS AXIAL FAN BLOWER

⚠ WARNING! To avoid accidental starting remove batteries from tool when not in use. To keep from scattering debris, blow around the outer edges of a debris pile. Never blow directly into the centre of a pile.

Use rakes and brooms to loosen debris before blowing. In dusty conditions, slightly dampen surfaces when water is available.

Conserve water by using power blowers instead of hoses for many lawn and garden applications, including areas such as gutters, screens, patios, grills, porches, and gardens.

Watch out for children, pets, open windows, or freshly washed cars, and blow debris safely away.

After using brushless axial fan blower or other equipment, clean up!

Dispose of debris properly.

MAINTENANCE

⚠ WARNING! When servicing, use only identical replacement parts. Use of any other parts may create a hazard or cause product damage.

⚠ WARNING! Always wear safety goggles or safety glasses with side shields during power tool operation or when blowing dust. If operation is dusty, also wear a dust mask.

⚠ WARNING! To avoid serious personal injury, always remove the battery pack from the product when cleaning or performing any maintenance.

Avoid using solvents when cleaning plastic parts. Most plastics are susceptible to damage from various types of commercial solvents and may be damaged by their use. Use clean cloths to remove dirt, dust, oil, grease, etc.

⚠ WARNING! Do not at any time let brake fluids, gasoline, petroleum-based products, penetrating oils, etc., come in contact with plastic parts. Chemicals can damage, weaken or destroy plastic which may result in serious personal injury.

⚠ WARNING! To avoid serious personal injury, always remove the battery pack from the product when cleaning or performing any maintenance.

STORAGE

Clean all foreign material from the brushless axial fan blower.

Store indoors in a place that is inaccessible to children.

Keep away from corrosive agents such as garden chemicals and de-icing salts.

EXPLODED VIEW

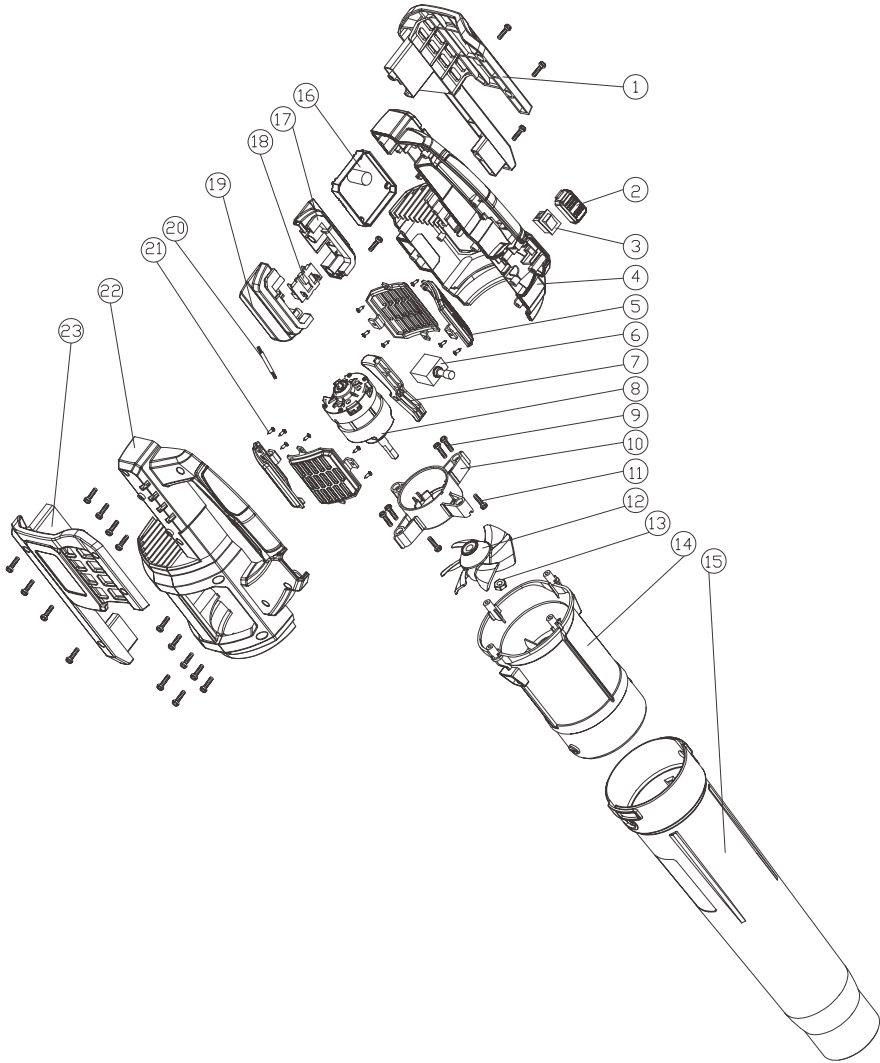

PARTS LIST

⚠ WARNING: When servicing, use only original equipment replacement parts. The use of any other parts may create a safety hazard or cause damage to the brushless axial fan blower.

Any attempt to repair or replace electrical parts on this fan blower may create a safety hazard unless repairs are performed by a qualified technician. For more information, call the Toll-free Helpline, at 1-866-349-8665; Monday - Friday: 9am to 5pm Eastern Standard Time.

Always order by key number.

Key #	Part #	Part Name	Quantity
1	3121800101039001	Left Bracket	1
2	3121810101058001	Turbo Button	1
3	3421800101032001	Turbo Switch	1
4	3121800101001001	Left Casing	1
5	3121800101069001	Air Intake Cover	4
6	3421810101032001	On/Off Switch	1
7	3121800101157001	Switch Lever	1
8	3421810101004001	Motor	1
9	33SBAQA004160101	Screw	24
10	3121800201039001	Motor Mounting Bracket	1
11	33SBADM005200101	Screw	2
12	3121800101022001	Fan	1
13	33NID0080101	Locknut	1
14	3121800101076001	Primary Exhaust Duct	1
15	312180201076001	Extension Duck	1
16	3421810101092001	Motor Controller	1
17	3121800301039001	Right Battery Support	1
18	3100810101049001	Insert	2
19	3121800401039001	Battery Left Bracket	1
20	3121810101027001	Internal Wiring 1	1
21	33SBADA003080102	Screw	12
22	3121800101002001	Right Casing	1
23	3121800501039001	Right Bracket	1

WARRANTY

BENCHMARK BRUSHLESS AXIAL FAN BLOWER WARRANTY

If this Benchmark tool fails due to a defect in material or workmanship within five years from the date of purchase, return it to any Home Hardware store with the original bill of sale for exchange. 3 Year warranty for the battery and charger.

This warranty does not include expendable parts including but not limited to blades, brushes, belts, light bulbs. This warranty covers defects in material or workmanship only. It does not cover normal wear and tear, failure due to abuse/misuse, or defects caused by careless or accidental mishandling. If this Benchmark product is used for commercial or rental purposes, this warranty does not apply.

20V MAX BRUSHLESS AXIAL FAN BLOWER



Includes 1 battery & 1 charger
5 Year Limited Warranty on tool
3 Year Limited Warranty on battery and charger

BENCHMARKTM_{MC}

BENCHMARK TOOLS CANADA
ST. JACOBS, ONTARIO N0B 2N0
© 2020 Home Hardware Stores Limited

CUSTOMER SERVICE/TECH SUPPORT
1-866-349-8665

5073-048

Made in China



* This BenchmarkTM product carries a five (5) year LIMITED warranty against defects in workmanship and materials. The charger and batteries carry a three (3) year LIMITED warranty. See Owner's Manual for full details.



800874
GY218101

**READ ALL INSTRUCTIONS BEFORE FIRST USE.
KEEP THIS MANUAL FOR FUTURE REFERENCE.
KEEP AWAY FROM CHILDREN.**

Maximum initial battery voltage (measured without a load)
is 20 volts. Nominal voltage is 18 volts.



**WEAR CSA APPROVED
EYE PROTECTION**



**WEAR EAR
PROTECTION**



**WEAR A
FACE MASK**