

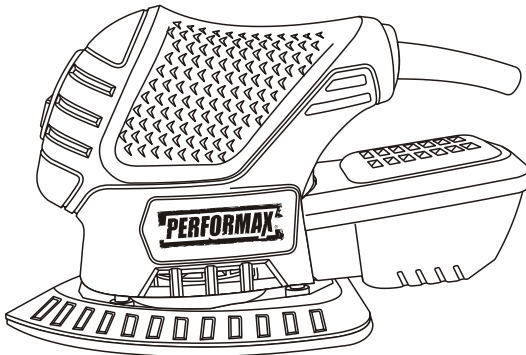

COMPACT DETAIL SANDER

241-0969

Owner's Manual



PRODUCT SPECIFICATIONS

Rating:	120 V, 60 Hz AC
Amperes:	0.8 A
Speed:	13,000 OPM (no load)
Sanding pad size:	5¼" x 3½" (133mm x 83mm)
Tool weight:	1 lb 12 oz (0.78 kg)

Need Assistance?

Call us on our toll free customer support line:
1-866-349-8665 (Monday through Friday 9am – 5pm
Eastern Time)

- Technical questions
- Replacement parts
- Parts missing from package

TABLE OF CONTENTS

Product specifications	1
Table of contents	2
General safety warnings	3-4
Eye, ear & lung protection	3-4
Electrical safety	4
Power tool safety	5-6
General safety rules	5
Work area	5
Electrical safety	5
Personal safety	5-6
Power tool use and care	6
Service	6
Specific safety rules	7
Guidelines for extension cords	8
Symbols	9
Know your compact detail sander	10
Assembly and operating	11-14
Installing the dust box assembly	11
Cleaning the dust box	11
Installing sandpaper	11-12
Installing detail sander accessory	12
Sandpaper selection	12
ON/OFF switch	13
Sanding	13-14
Maintenance	15
Exploded view	16
Parts list	17
Warranty	18

GENERAL SAFETY WARNINGS

 **WARNING:** Before using this tool or any of its accessories, read this manual and follow all Safety Rules and Operating Instructions. The important precautions, safeguards and instructions appearing in this manual are not meant to cover all possible situations. It must be understood that common sense and caution are factors which cannot be built into the product.

This instruction manual includes the following:

- General Safety Rules
- Specific Safety Rules and Symbols
- Functional Description
- Assembly
- Operation
- Maintenance
- Accessories

EYE, EAR & LUNG PROTECTION



ALWAYS WEAR EYE PROTECTION THAT CONFORMS WITH CSA REQUIREMENTS or ANSI SAFETY STANDARD Z87.1

FLYING DEBRIS can cause permanent eye damage. Prescription eyeglasses ARE NOT a replacement for proper eye protection.



WARNING: Non-compliant eyewear can cause serious injury if broken during the operation of a power tool.



WARNING: Use hearing protection, particularly during extended periods of operation of the tool, or if the operation is noisy.

SAVE THESE INSTRUCTIONS FOR REFERENCE

GENERAL SAFETY WARNINGS



WEAR A DUST MASK THAT IS DESIGNED TO BE USED WHEN OPERATING A POWER TOOL IN A DUSTY ENVIRONMENT.



WARNING: Dust that is created by power sanding, sawing, grinding, drilling, and other construction activities may contain chemicals that are known to cause cancer, birth defects, or other genetic abnormalities. These chemicals include:

Lead from lead-based paints
Crystalline silica from bricks, cement, and other masonry products
Arsenic and chromium from chemically treated lumber

The level of risk from exposure to these chemicals varies, according to how often this type of work is performed. In order to reduce exposure to these chemicals, work in a well-ventilated area, and use approved safety equipment, such as a dust mask that is specifically designed to filter out microscopic particles.

ELECTRICAL SAFETY



WARNING: To avoid electrical hazards, fire hazards or damage to the tool, use proper circuit protection.

This tool is wired at the factory for 120 V AC operation. It must be connected to a 120 V AC, 15 A circuit that is protected by a time-delayed fuse or circuit breaker. To avoid shock or fire, replace power cord immediately if it is worn, cut or damaged in any way.

SAVE THESE INSTRUCTIONS FOR REFERENCE

POWER TOOL SAFETY

▲ WARNING: Read all safety warnings and instructions. Failure to follow the warnings and instructions may result in electric shock, fire and/or serious injury.

Save all warnings and instructions for future reference.

Work area safety

Keep work area clean and well lit. Cluttered or dark areas invite accidents.

Do not operate power tools in explosive atmospheres, such as in the presence of flammable liquids, gases or dust. Power tools create sparks which may ignite the dust or fumes.

Keep children and bystanders away while operating a power tool. Distractions can cause you to lose control.

Electrical safety

Power tool plugs must match the outlet. Never modify the plug in any way. Do not use any adapter plugs with earthed (grounded) power tools. Unmodified plugs and matching outlets will reduce risk of electric shock.

Avoid body contact with earthed or grounded surfaces such as pipes, radiators, ranges and refrigerators. There is an increased risk of electric shock if your body is earthed or grounded.

Do not expose power tools to rain or wet conditions. Water entering a power tool will increase the risk of electric shock.

Do not abuse the cord. Never use the cord for carrying, pulling or unplugging the power tool. Keep cord away from heat, oil, sharp edges or moving parts. Damaged or entangled cords increase the risk of electric shock.

When operating a power tool outdoors, use an extension cord suitable for outdoor use. Use of a cord suitable for outdoor use reduces the risk of electric shock.

If operating a power tool in a damp location is unavoidable, use a residual current device (RCD) protected supply. Use of a ground fault circuit interrupter (GFCI) reduces the risk of electric shock.

Personal safety

Stay alert, watch what you are doing and use common sense when operating a power tool. Do not use a power tool while you are tired or under the influence of drugs, alcohol or medication. A moment of inattention while operating power tools may result in serious personal injury.

Use personal protective equipment. Always wear eye protection. Protective equipment such as dust mask, non-skid safety shoes, hard hat, or hearing protection used for appropriate conditions will reduce personal injuries.

Prevent unintentional starting. Ensure the switch is in the off-position before connecting to power source and/or battery pack, picking up or carrying the tool. Carrying power tools with your finger on the switch or energizing power tools that have the switch on invites accidents.

Remove any adjusting key or wrench before turning the power tool on. A wrench or a key left attached to a rotating part of the power tool may result in personal injury.

Do not overreach. Keep proper footing and balance at all times. This enables better control of the power tool in unexpected situations.

Dress properly. Do not wear loose clothing or jewellery. Keep your hair, clothing and gloves away from moving parts. Loose clothes, jewellery or long hair can be caught in moving parts.

SAVE THESE INSTRUCTIONS FOR REFERENCE

POWER TOOL SAFETY

Personal safety – cont'd

If devices are provided for the connection of dust extraction and collection facilities, ensure these are connected and properly used. Use of dust collection can reduce dust-related hazards.

Power tool use and care

Do not force the power tool. Use the correct power tool for your application. The correct power tool will do the job better and safer at the rate for which it was designed.

Do not use the power tool if the switch does not turn it on and off. Any power tool that cannot be controlled with the switch is dangerous and must be repaired.

Disconnect the plug from the power source and/or the battery pack from the power tool before making any adjustments, changing accessories, or storing power tools. Such preventive safety measures reduce the risk of starting the power tool accidentally.

Store idle power tools out of the reach of children and do not allow persons unfamiliar with the power tool or these instructions to operate the power tool. Power tools are dangerous in the hands of untrained users.

Maintain power tools. Check for misalignment or binding of moving parts, breakage of parts and any other condition that may affect the power tool's operation. If damaged, have the power tool repaired before use. Many accidents are caused by poorly maintained power tools.

Keep cutting tools sharp and clean. Properly maintained cutting tools with sharp cutting edges are less likely to bind and are easier to control.

Use the power tool, accessories and tool bits etc. in accordance with these instructions, taking into account the working conditions and the work to be performed. Use of the power tool for operations different from those intended could result in a hazardous situation.

Service

Have your power tool serviced by a qualified repair person using only identical replacement parts. This will ensure that the safety of the power tool is maintained.

SAVE THESE INSTRUCTIONS FOR REFERENCE

SPECIFIC SAFETY RULES

⚠ WARNING: Know your compact detail sander. Do not plug in the sander until you have read and understand this Instruction Manual. Learn the tool's applications and limitations, as well as the specific potential hazards related to this tool. Following this rule will reduce the risk of electric shock, fire, or serious injury.



Always wear eye protection. Any power tool can throw foreign objects into your eyes and cause permanent eye damage.

ALWAYS wear safety goggles (not glasses) that comply with ANSI safety standard Z87.1. Everyday glasses have only impact resistant lenses. They ARE NOT safety glasses.

⚠ WARNING: Glasses or goggles not in compliance with ANSI Z87.1 could cause serious injury when they break.

⚠ WARNING: Always use a dust mask when sanding.

⚠ WARNING: Always use hearing protection when sanding, particularly during extended periods of operation.

⚠ WARNING: Always unplug the tool from the power source before changing accessories, sandpaper and when cleaning the tool.

Do not wear gloves, neckties or loose clothing.

Secure the workpiece. Use clamps or a vise to hold the work when practical. It is safer than using your hand and it frees both hands to operate the tool.

Do not sand material too small to be securely held.

Make sure there are no nails or foreign objects in the part of the workpiece to be sanded.

Always keep hands out of the path of the sanding pad. Avoid awkward hand positions where a sudden slip could cause your hand to move into the path of the sanding pad.

To avoid injury from accidental starting, always remove the plug from the power source before installing or removing dust box.

SAVE THESE INSTRUCTIONS FOR REFERENCE

GUIDELINES FOR EXTENSION CORDS

Make sure your extension cord is the proper size. When using an extension cord, be sure to use one heavy enough to carry the current the tool will draw. An undersized cord will cause a drop in line voltage resulting in loss of power and overheating. The table on at right shows the correct size to use according to cord length and nameplate ampere rating. If in doubt, use the next heavier gauge. The smaller the gauge number the heavier the cord.

Be sure your extension cord is properly wired and in good condition. Always replace a damaged extension cord or have it repaired by a qualified electrician before using it. Protect your extension cord from sharp objects, excessive heat and damp or wet areas.

Use a separate electrical circuit for your power tools. This circuit must not be less than 14 gauge wire and should be protected with either a 15A time delay fuse or circuit breaker. Before connecting the power tool to the power source, make sure the switch is in the OFF position and the power source is the same as indicated on the nameplate. Running at lower voltage will damage the motor.

⚠ WARNING: Repair or replace damaged or worn extension cords immediately.

Select the appropriate extension cord gauge and length using the chart below.

When operating a power tool outdoors, use an outdoor extension cord marked “W-A” or “W”. These cords are rated for outdoor use and reduce the risk of electric shock.

⚠ WARNING: Keep the extension cord clear of the working area. Position the cord so it will not get caught on the workpiece, tools or any other obstructions while you are working with the power tool.



MINIMUM GAUGE (AWG) EXTENSION CORDS (120 V use only)











Ampere rating		Total length in feet			
More than	Not more than	7.5 m (25')	15 m (50')	30 m (100')	45 m (150')
0	6	18	16	16	14
6	10	18	16	14	12
10	12	16	16	14	12
12	16	14	12	Not Applicable	

SAVE THESE INSTRUCTIONS FOR REFERENCE

SYMBOLS

▲ WARNING: Some of the following symbols may appear on the palm sander. Study these symbols and learn their meaning. Proper interpretation of these symbols will allow for more efficient and safer operation of this tool.

V	Volts
A	Amperes
Hz	Hertz
W	Watts
kW	Kilowatts
μF	Microfarads
L	Liters
kg	Kilograms
H	Hours
N/cm ²	Newtons per square centimeter
Pa	Pascals
OPM	Oscillations per minute
Min	Minutes
S	Seconds
 or a.c.	Alternating current
	Three-phase alternating current
	Three-phase alternating current with neutral

	Direct current
n_0	No load speed
	Alternating or direct current
	Class II construction
	Splash-proof construction
	Watertight construction
	Protective grounding at grounding terminal, Class I tools
.../min	Revolutions or reciprocations per minute
∅	Diameter
0	Off position
	Directional arrow
	Warning symbol
	Wear your safety glasses
	Wear a dust mask
	Wear hearing protection



This symbol designates that this tool is listed with U.S. and Canadian requirements by ETL Testing Laboratories, Inc. Conforms to UL Std. 60745-1 and 60745-2-4.

KNOW YOUR COMPACT DETAIL SANDER

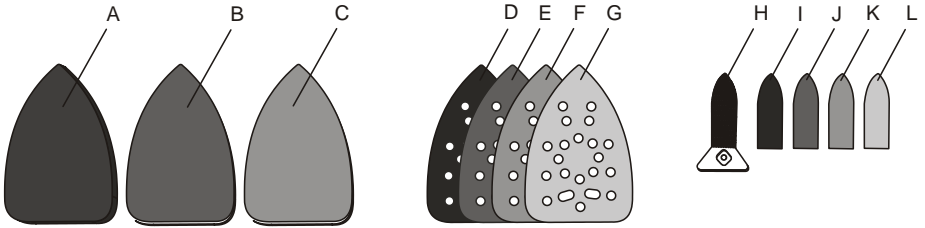
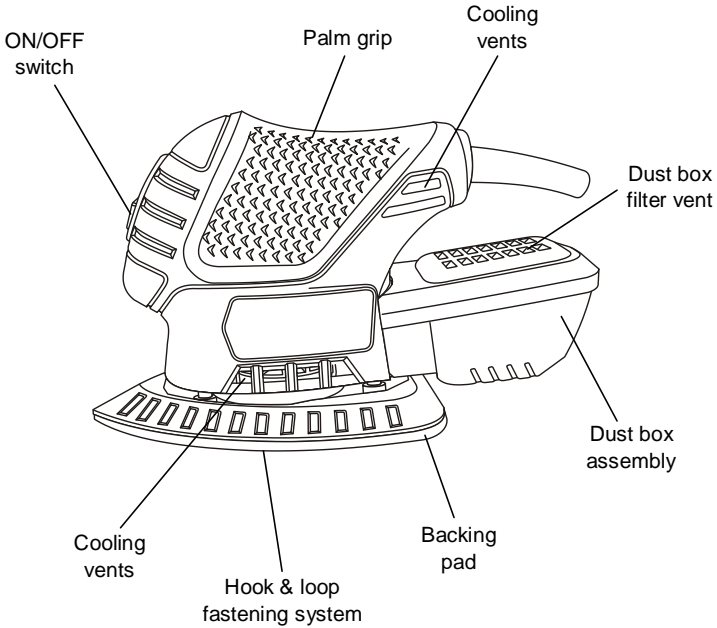

Specialty Pads		
Key	Description	Qty
A	Scrubbing	1
B	Foam	1
C	Abrasive	1

Hook & Loop Sandpaper		
Key	Description	Qty
D	80 Grit	3
E	100 Grit	3
F	120 Grit	3
G	240 Grit	3

Hook & Loop Detail Sandpaper		
Key	Description	Qty
H	Detail sander pad	1
I	80 Grit	3
J	100 Grit	3
K	120 Grit	3
L	240 Grit	3

ASSEMBLY AND OPERATING

INSTALLING THE DUST BOX ASSEMBLY

1. Insert the dust duct box assembly (1) onto the dust chute (2) (Fig. 1).
2. Push the dust box assembly fully onto the dust chute.
NOTE: Remove and clean the dust box assembly periodically to remove accumulated dust from the dust box.

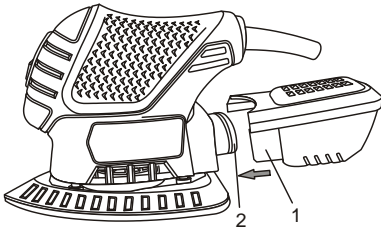

Fig. 1

CLEANING THE DUST BOX

The dust box will collect much of the sanding dust that is generated during sanding operations. As a result, it must be cleaned out periodically so the dust collection will be efficient.

1. Grasp the sides of the dust box (1) and pull it away from the rear of the dust chute (2) (Fig. 2).

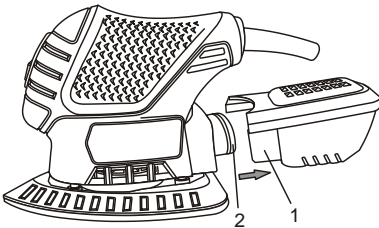

Fig. 2

2. Insert a small flat blade screwdriver at the front of the dust box assembly (3) and carefully pry the top of the dust box (4) away from the bottom of the dust box (5) (Fig. 3).
NOTE: It is best to perform this function either outside or over a trash can, as loose dust will come out of the dust box very easily.
3. Shake all the dust out of the dust box.
4. Use a soft DRY brush to remove the dust from the filter located inside the top of the dust box.
5. Once all the sanding dust is removed from the dust box, press the upper and lower sections together. They will "snap" into place when properly assembled.
6. Reinstall the dust box onto the rear of the sander.
NOTE: Make sure the dust box assembly is fully pushed onto the rear of the sander.

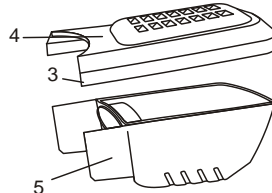

Fig. 3

INSTALLING SANDPAPER

⚠ WARNING: Unplug the sander from the power source before installing or changing the sandpaper.

1. Firmly press the sandpaper (1) onto the hook & loop pad (2) (Fig. 4).

NOTES:

- a) Place the sandpaper so the holes line up with the matching holes in the hook & loop pad.
- b) Press the sandpaper firmly onto the hook & loop pad.

ASSEMBLY AND OPERATING

INSTALLING SANDPAPER – cont'd

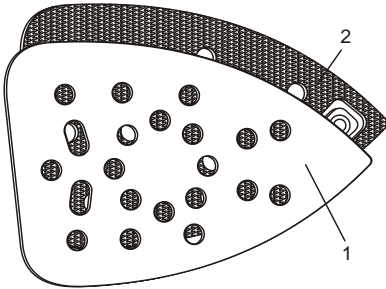

Fig. 4

2. To remove the sandpaper (1), simply peel the sandpaper away from the hook & loop pad (2) (Fig. 5).

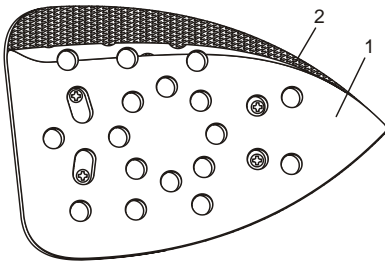

Fig. 5

INSTALLING DETAIL SANDING ACCESSORY

The detail sanding accessory should be attached to the main sanding pad for sanding in small areas.

1. Remove sandpaper from the main sanding pad (1) (Fig. 6).
2. Place the detail sanding accessory (2) onto the main sanding pad mounting hole (3).
3. Fasten the detail sanding accessory to the main sanding pad using the screw (4) provided.
4. Tighten the mounting screw using a #2 \oplus screwdriver.

5. Install the appropriate sandpaper (5) to the detail sanding accessory.

NOTE: See Fig. 4 & 5 for installing and removing the hook & loop sandpaper.

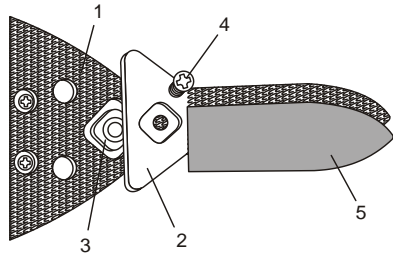

Fig. 6

SANDPAPER SELECTION

Make sure you select the correct size and style of sandpaper for your sander. The correct sandpaper will:

- Fit onto the sanding pad with no overhang or exposed sanding pad
- Have 3/8" holes that match the hole pattern in the sander base
- Have a backing for use with the hook & loop disc attachment system.

Selecting the correct grit and type of sandpaper is extremely important in achieving a high quality sanded finish. Aluminum oxide, silicon carbide and other synthetic abrasives are best for power sanding. **Natural abrasives such as flint and garnet are too soft for economical use in power sanding.**

In general, coarse grit will remove the most material and finer grit will produce the best finish in all sanding operations. The condition of the surface to be sanded will determine which grit will do the best job.

NOTE: Where the sandpaper grits are shown numerically, higher numbers indicate finer grit and lower numbers indicate coarser grit.

If the surface is rough, start with a coarse grit and sand until the surface is uniform. Medium grit may then be used to remove scratches left by the coarser grit. Fine grit should be used for finishing the surface. Always continue sanding with each grit until the surface is uniform.

ASSEMBLY AND OPERATING

▲ WARNING

For safety reasons, the operator must read the sections of this Owner's Manual entitled "GENERAL SAFETY WARNINGS", "POWER TOOL SAFETY", "SPECIFIC SAFETY RULES", "GUIDELINES FOR EXTENSION CORDS" and "SYMBOLS" before using this compact detail sander.

Verify the following every time the compact detail sander is used:

1. Sander cord is not damaged.
2. Safety glasses and dust mask are being worn.
3. Hearing protection is being worn.
4. Sandpaper is the correct type for the job.
5. Sandpaper is in good condition and is properly installed.

Failure to observe these safety rules will significantly increase the risk of injury.

▲ WARNING: Always wear safety goggles or safety glasses with side shields when operating your sander. Failure to do so could result in foreign objects being thrown into your eyes resulting in possible serious eye damage.

Always wear an appropriate dust mask and hearing protection when using your sander.

ON/OFF SWITCH

To turn the sander ON, push the upper switch button (1) until the sander starts. To turn the sander OFF, press the lower switch button (2) (Fig. 7).

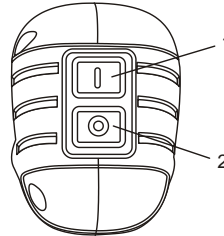

Fig. 7

SANDING

Clamp or otherwise secure your workpiece to prevent it from moving under the sander while being sanded.

▲ WARNING: An unsecured workpiece could be thrown toward the operator causing injury.

▲ WARNING: Your sander should only be turned ON when the entire surface of the sanding pad is in contact with the workpiece. Failure to follow this sanding procedure could result in loose sandpaper which could result in possible injury.

Place the sander on the workpiece so that the complete sandpaper surface is in contact with the workpiece. Turn the sander ON by pressing on the upper ON/OFF switch button. Move the sander slowly over workpiece making successive passes in parallel lines, circles or crosswise movements. Because the random orbital motion of the sanding pad moves in tiny circles, it is not necessary to move the sander with the grain or in the same direction for successive passes (Fig. 8).

ASSEMBLY AND OPERATING

SANDING – cont'd

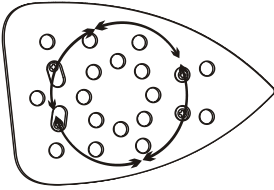

Fig. 8

NOTE: Hold the detail sander using the grip on top of the sander. Be careful NOT to cover the motor cooling vents (1) with your hand (Fig. 9). Motor damage may occur from overheating if the cooling vents are covered.

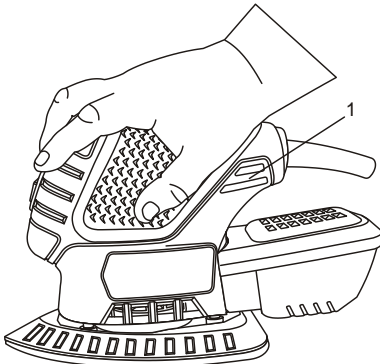

Fig. 9

DO NOT FORCE THE SANDER. The weight of the sander usually provides adequate pressure. Let the sander and the sandpaper do the work. Applying added pressure will slow the motor, increase the wear on the sandpaper and greatly reduce the sander speed. Motor damage may occur if excessive downward pressure is applied. It will also create an inferior finish on sanded work. Any finish or resin on wood will soften from the frictional heat, causing the sandpaper to become clogged very quickly. Do not sand in one spot too long as the sander's rapid action may remove too much material, making the surface uneven.

Extended periods of sanding may cause the motor to run hot. If this occurs, turn the sander OFF and wait until the sanding pad comes to a complete stop before lifting it from the workpiece. While allowing the motor to cool down, brush, shake or vacuum any dust accumulated in the vents before continuing the sanding operation.

Upon completion of the sanding operation, turn the sander OFF by pressing on the lower ON/OFF switch button. Wait until the sanding pad comes to a complete stop before removing it from the workpiece.

MAINTENANCE

GENERAL

⚠ WARNING: When servicing, use only identical replacement parts. Use of any other replacement parts may create a hazard or cause product damage.

DO NOT use solvents when cleaning plastic parts. Most plastics are susceptible to damage from various types of commercial solvents and may be damaged by their use. Use a clean cloth to remove dirt, dust, oil, grease etc.

⚠ WARNING: Do not at any time allow brake fluids, gasoline, petroleum-based products, penetrating oils, etc. to come in contact with plastic parts. They contain chemicals that can damage, weaken or destroy plastic.

DO NOT abuse power tools. Abusive practices can damage the tool as well as the workpiece.

⚠ WARNING: DO NOT attempt to modify tools or create accessories not recommended. Any such alteration or modification is misuse and could result in a hazardous condition leading to possible serious injury. It will also void the warranty.

It has been found that electric tools are subjected to accelerated wear and possible premature failure when they are used on fiberglass boats and automotive parts, wallboard, spackling compounds or plaster. The chips and grindings from these materials are highly abrasive to electric tool parts such as bearings, brushes, commutators, etc. Consequently, it is not recommended that this tool be used for extended work on any fiberglass material, wallboard, spackling compounds or plaster. During any use on these materials it is extremely important that the tool is cleaned frequently by blowing the dust out of the tool with an air jet.

⚠ WARNING: Always wear safety goggles or safety glasses with side shields during all sanding operations. It is critical that you also wear safety goggles or safety glasses with side shields and a dust mask while blowing dust out of the sander with an air jet. Failure to take these safety precautions could result in permanent eye or lung damage.

LUBRICATION

All of the bearings in this compact detail sander are lubricated with a sufficient amount of high grade lubricant for the life of the unit under normal conditions. Therefore, no further lubrication is required.

EXPLODED VIEW

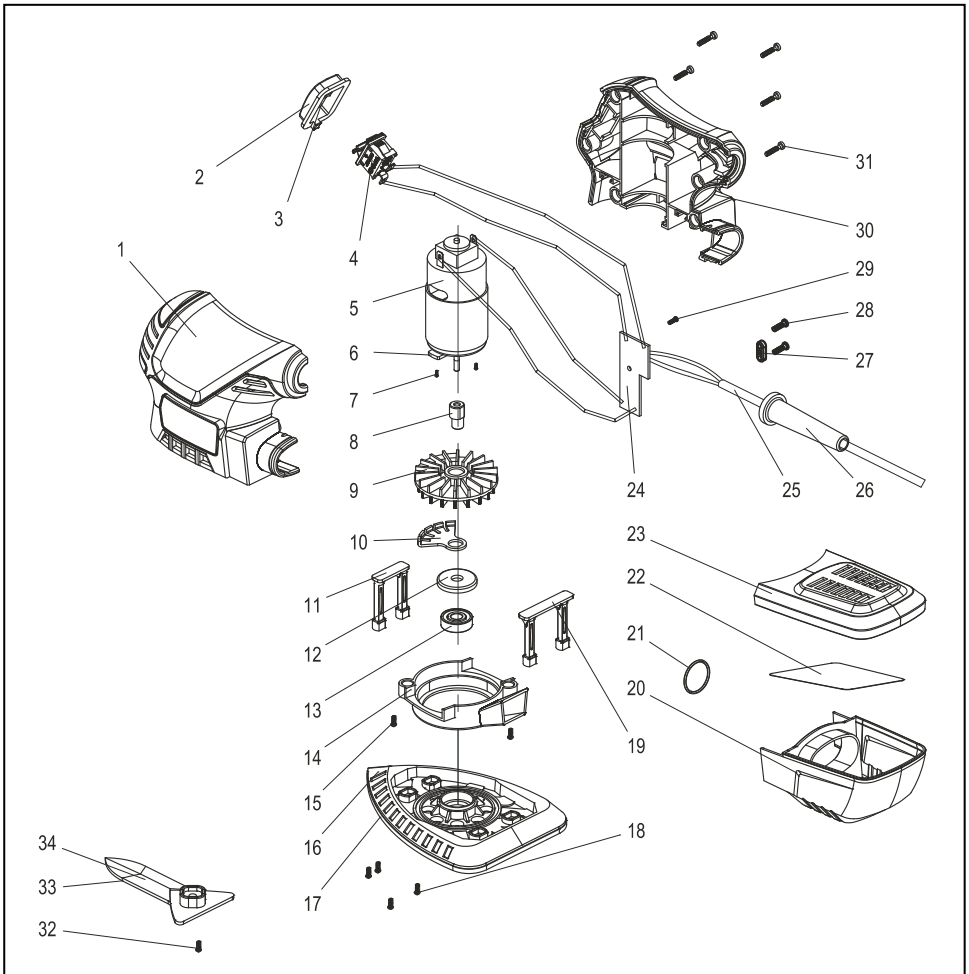

PARTS LIST

▲ WARNING: When servicing, use only original equipment replacement parts. The use of any other parts may create a safety hazard or cause damage to the sander.

Any attempt to repair or replace electrical parts on this sander may create a safety hazard unless repairs are performed by a qualified technician. For more information, call the Toll-free Helpline, at 1-866-349-8665 Eastern Time.

Always order by PART NUMBER, not by key number.

Key #	Part #	Part Name	Quantity
1	3011080037	Housing	1
2	3140080044	Switch button	1
3	3190050006	Flat washer	2
4	1061250004	Switch	1
5	1039040013	Motor	1
6	2030220006	Motor flange	1
7	4020010027	Screw M3*6	2
8	2010130053	Bushing	1
9	3150010119	Fan	1
10	2030030290	Counter balance	1
11	3150110008	Oscillating bracket	1
12	3180050025	Dust washer	1
13	4010010053	Bearing 607-2rs	1
14	3180050026	Dust cover	1
15	4030010026	Tapping screw ST2.9*9	2
16	3150120097	Base plate	1
17	3190020072	Hook pad	1
18	3190020073	Tapping screw ST2.9*9	1
19	4030010026	Oscillating bracket	4
20	3150110009	Dust box	1
21	3180020040	O ring	1
22	6150020009	Dust filter	1
23	3180030028	Dust box cover	1
24	1130090016	PCB	1
25	1190030013	Cord	1
26	3140010054	Cord sleeve	1
27	2030050009	Strain relief	1
28	4030010099	Tapping screw ST3.9*14	2
29	4030010026	Tapping screw ST2.9*9	1
30	3011080037	Housing	1
31	4030010106	Tapping screw ST3.9*19	6
32	4020010001	Screw M4*8	1
33	3190100019	Hook pad	1
34	3150120098	Finger plate	1

PERFORMAX® COMPACT DETAIL SANDER WARRANTY

30-DAY MONEY BACK GUARANTEE:

This PERFORMAX® brand power tool carries our 30-Day Money Back Guarantee. If you are not completely satisfied with your PERFORMAX® brand power tool for any reason within thirty (30) days from the date of purchase, return the tool with your original receipt to any MENARDS® retail store, and we will provide you a refund – no questions asked.

2-YEAR LIMITED WARRANTY:

This PERFORMAX® brand power tool carries a 2-Year Limited Warranty to the original purchaser. If, during normal use, this PERFORMAX® power tool breaks or fails due to a defect in material or workmanship within two (2) years from the date of original purchase, simply bring this tool with the original sales receipt back to your nearest MENARDS® retail store. At its discretion, PERFORMAX® agrees to have the tool or any defective part(s) repaired or replaced with the same or similar PERFORMAX® product or part free of charge, within the stated warranty period, when returned by the original purchaser with original sales receipt. Notwithstanding the foregoing, this limited warranty does not cover any damage that has resulted from abuse or misuse of the Merchandise. This warranty: (1) excludes expendable parts including but not limited to blades, brushes, belts, bits, light bulbs, and/or batteries; (2) shall be void if this tool is used for commercial and/or rental purposes; and (3) does not cover any losses, injuries to persons/property or costs. This warranty does give you specific legal rights and you may have other rights, which vary from state to state. Be careful, tools are dangerous if improperly used or maintained. Seller's employees are not qualified to advise you on the use of this Merchandise. Any oral representation(s) made will not be binding on seller or its employees. The rights under this limited warranty are to the original purchaser of the Merchandise and may not be transferred to any subsequent owner. This limited warranty is in lieu of all warranties, expressed or implied including warranties or merchantability and fitness for a particular purpose. Seller shall not be liable for any special, incidental, or consequential damages. The sole exclusive remedy against the seller will be for the replacement of any defects as provided herein, as long as the seller is willing or able to replace this product or is willing to refund the purchase price as provided above. For insurance purposes, seller is not allowed to demonstrate any of these power tools for you.

For questions / comments, technical assistance or repair parts –
Please Call Toll Free at: 1-866-349-8665 (M-F 8am – 6pm)

SAVE YOUR RECEIPTS. THIS WARRANTY IS VOID WITHOUT THEM.

Distributed by: Menard, Inc., Eau Claire, WI 54703