

Radley®

3/8" Drill



*Owner's
Manual*



Intertek
3042597
JD2025U

**READ ALL INSTRUCTIONS BEFORE FIRST USE.
KEEP THIS MANUAL FOR FUTURE REFERENCE.
KEEP AWAY FROM CHILDREN.**



**WEAR CSA APPROVED
EYE PROTECTION**



**WEAR EAR
PROTECTION**



**WEAR A
FACE MASK**

PRODUCT SPECIFICATIONS

3/8" DRILL	
Rating	120V, 60Hz, AC
Amperes	4.0 A
Motor speed	0-3,000 RPM (no load)
Chuck	3/8" Keyless
Maximum drilling capacity in wood	3/4" / 20mm
Maximum drilling capacity in metal	3/8" / 10mm
Weight	3 lb 5 oz /1.5 kg

Need Assistance?

Call us on our toll free customer support line:

1-866-349-8665 (Monday through Friday 9am – 5pm Eastern Time)

- Technical questions
- Replacement parts
- Parts missing from package

TABLE OF CONTENTS

Product specifications	1
Table of contents	2
General safety warnings	3-4
Eye, ear & lung protection	3
Electrical safety	4
Power tool safety	4-6
Work area safety	4
Personal safety	5
Power tool use and care	5-6
Service	6
Specific safety rules	7-8
Guidelines for extension cords	8
Symbols	9-10
Know your drill	11
Assembly and operating	12-16
Forward/reverse switch	12
Variable-speed trigger switch	12
Installing drill bits	12-13
Removing drill bits	13
Trigger switch lock	13
Drilling	14-15
Removing the chuck	15
Retightening a loose chuck	16
Maintenance	17
Exploded view	18
Parts list	19
Warranty	20



GENERAL SAFETY WARNINGS

WARNING: Before using this tool or any of its accessories, read this manual and follow all Safety Rules and Operating Instructions. The important precautions, safeguards and instructions appearing in this manual are not meant to cover all possible situations. It must be understood that common sense and caution are factors which cannot be built into the product.

This instruction manual includes the following:

- General Safety Warnings
- Specific Safety Rules and Symbols
- Functional Description
- Assembly
- Operation
- Maintenance
- Accessories

EYE, EAR & LUNG PROTECTION



**WEAR CSA APPROVED
EYE PROTECTION**



**WEAR EAR
PROTECTION**



**WEAR A
FACE MASK**

ALWAYS WEAR EYE PROTECTION THAT CONFORMS WITH CSA REQUIREMENTS or ANSI SAFETY STANDARD Z87.1

FLYING DEBRIS can cause permanent eye damage. Prescription eyeglasses ARE NOT a replacement for proper eye protection. **WARNING:** Non-compliant eyewear can cause serious injury if broken during the operation of a power tool.

ALWAYS WEAR EAR PROTECTION

WARNING: Use hearing protection, particularly during extended periods of operation of the tool, or if the operation is noisy.

WEAR A DUST MASK THAT IS DESIGNED TO BE USED WHEN OPERATING A POWER TOOL IN A DUSTY ENVIRONMENT.

WARNING: Dust that is created by power sanding, sawing, grinding, drilling, and other construction activities may contain chemicals that are known to cause cancer, birth defects, or other genetic abnormalities. These chemicals include: Lead from lead-based paints; Crystalline silica from bricks, cement, and other masonry products; Arsenic and chromium from chemically treated lumber. The level of risk from exposure to these chemicals varies, according to how often this type of work is performed. In order to reduce exposure to these chemicals, work in a well-ventilated area, and use approved safety equipment, such as a dust mask that is specifically designed to filter out microscopic particles.

ELECTRICAL SAFETY



WARNING: To avoid electrical hazards, fire hazards or damage to the tool, use proper circuit protection.

This tool is wired at the factory for 120V AC operation. It must be connected to a 120V AC, 15 A circuit that is protected by a time-delayed fuse or circuit breaker. To avoid shock or fire, replace power cord immediately if it is worn, cut or damaged in any way.

POWER TOOL SAFETY

WARNING. Read all safety warnings and instructions. Failure to follow the warnings and instructions may result in electric shock, fire and/or serious injury. Save all warnings and instructions for future reference.

WORK AREA SAFETY

Keep work area clean and well lit. Cluttered or dark areas invite accidents. Do not operate power tools in the presence of flammable liquids, gases or dust. Power tools create sparks which may ignite the dust or fumes. Keep children and bystanders away while operating a power tool. Distractions can cause you to lose control.

Power tool plugs must match the outlet. Never modify the plug in any way. Do not use any adapter plugs with earthed (grounded) power tools. Unmodified plugs and matching outlets will reduce risk of electric shock.

Avoid body contact with earthed or grounded surfaces such as pipes, radiators, ranges and refrigerators. There is an increased risk of electric shock if your body is earthed or grounded.

Do not expose power tools to rain or wet conditions. Water entering a power tool will increase the risk of electric shock.

Never use the cord for carrying, pulling or unplugging the power tool. Keep cord away from heat, oil, sharp edges or moving parts. Do not use a damaged or tangled cord.

When operating a power tool outdoors, use an extension cord suitable for outdoor use. If operating a power tool in a damp location is unavoidable, use a residual current device (RCD) protected supply. Use of a ground fault circuit interrupter (GFCI) reduces the risk of electric shock.

PERSONAL SAFETY

Stay alert, watch what you are doing and use common sense when operating a power tool. Do not use a power tool while you are tired or under the influence of drugs, alcohol or medication. A moment of inattention while operating power tools may result in serious personal injury.

Use personal protective equipment. Always wear eye protection. Protective equipment such as dust mask, non-skid safety shoes, hard hat, or hearing protection used for appropriate conditions will reduce personal injuries.

Prevent unintentional starting. Ensure the switch is in the off-position before connecting to power source and/or battery pack, picking up or carrying the tool. Carrying power tools with your finger on the switch or energizing power tools that have the switch on invites accidents.

Remove adjusting key or wrench before turning the power tool on. A wrench or a key left attached to a rotating part of the power tool may result in personal injury.

Do not overreach. Keep proper footing and balance at all times. This enables better control of the power tool in unexpected situations.

Do not wear loose clothing or jewellery. Keep your hair, clothing and gloves away from moving parts. Loose clothes, jewellery or long hair can be caught in moving parts.

If devices are provided for the connection of dust extraction and collection facilities, ensure these are connected and properly used. Use of dust collection can reduce dust-related hazards.

POWER TOOL USE AND CARE

Do not force the power tool. Use the correct power tool for your application. The correct power tool will do the job better and safer at the rate for which it was designed.

Do not use the power tool if the switch does not turn it on and off. Any power tool that cannot be controlled with the switch is dangerous and must be repaired.

Disconnect the plug from the power source and/or the battery pack from the power tool before making any adjustments, changing accessories, or storing power tools. Such preventive safety measures reduce the risk of starting the power tool accidentally.

Store idle power tools out of the reach of children and do not allow persons unfamiliar with the power tool or these instructions to operate the power tool.

Power tools are dangerous in the hands of untrained users.

Maintain power tools. Check for misalignment or binding of moving parts, breakage of parts and any other condition that may affect the power tool's operation. If damaged, have the power tool repaired before use. Many accidents are caused by poorly maintained power tools.

Keep cutting tools sharp and clean. Properly maintained cutting tools with sharp cutting edges are less likely to bind and are easier to control.

Use the power tool, accessories and tool bits etc. in accordance with these instructions, taking into account the working conditions and the work to be performed. Use of the power tool for operations different from those intended could result in a hazardous situation.

Hold power tools by insulated gripping surfaces when performing an operation where the cutting tool or fastener may contact hidden wiring or its own cord.

Contact with a live wire will make exposed metal parts of the tool live and shock the operator.

SERVICE

Have your power tool serviced by a qualified repair person using only identical replacement parts. This will ensure that the safety of the power tool is maintained.



SPECIFIC SAFETY RULES

WARNING: Know your drill. Do not plug in the drill until you have read and understand this Owner's Manual. Learn the tool's applications and limitations, as well as the specific potential hazards related to this tool. Following this rule will reduce the risk of electric shock, fire, or serious injury.



WEAR CSA APPROVED EYE PROTECTION

Always wear eye protection. Any power tool can throw foreign objects into your eyes and cause permanent eye damage. **ALWAYS** wear safety goggles (not glasses) that comply with ANSI safety standard Z87.1. Everyday glasses have only impact resistant lenses. They **ARE NOT** safety glasses.

WARNING: Glasses or goggles not in compliance with ANSI Z87.1 could cause serious injury when they break.

WARNING: Always use a safety shield, hearing protection and dust mask when drilling concrete.

Do not drill material too small to be securely held.

Always keep hands out of the path of the drill bit. Avoid awkward hand positions where a sudden slip could cause your hand to move into the path of the drill bit.

Secure the workpiece. Use clamps or a vice to hold the workpiece. It is safer than using your hand and it frees both hands to operate the tool.

Make sure there are no nails or foreign objects in the part of the workpiece to be drilled.

To avoid injury from accidental starting, always remove the plug from the power source before installing or removing a drill bit.

Do not install or use any drill bit that exceeds 7" (17.5 cm) in length or extends more than 6" (15 cm) beyond the chuck jaws. They can bend or break suddenly.

Before starting the operation, jog the drill switch to make sure the drill bit does not wobble or vibrate.

Do not use fly cutters or multiple-part hole cutters, because they can come apart or become unbalanced during use.

Make sure the spindle has come to a complete stop before touching the chuck or attempting to change the drill bit.

Always make sure the chuck is tight and the drill bit firmly tightened in the chuck before starting drill.

GUIDELINES FOR EXTENSION CORDS

Make sure your extension cord is the proper size. When using an extension cord, be sure to use one heavy enough to carry the current the tool will draw. An undersized cord will cause a drop in line voltage resulting in loss of power and overheating. The table below shows the correct size to use according to cord length and nameplate ampere rating. If in doubt, use the next heavier gauge. The smaller the gauge number the heavier the cord.

Be sure your extension cord is properly wired and in good condition. Always replace a damaged extension cord or have it repaired by a qualified electrician before using it. Protect your extension cord from sharp objects, excessive heat and damp or wet areas.

Use a separate electrical circuit for your power tools. This circuit must not be less than 14 gauge wire and should be protected with either a 15A time delay fuse or circuit breaker. Before connecting the power tool to the power source, make sure the switch is in the OFF position and the power source is the same as indicated on the nameplate. Running at lower voltage will damage the motor.

WARNING: Repair or replace damaged or worn extension cords immediately.

Select the appropriate extension cord gauge and length using the chart below.



When operating a power tool outdoors, use an outdoor extension cord marked “W-A” or “W”. These cords are rated for outdoor use and reduce the risk of electric shock.

WARNING: Keep the extension cord clear of the working area. Position the cord so it will not get caught on the workpiece, tools or any other obstructions while you are working with the power tool.











MINIMUM GAUGE (AWG) EXTENSION CORDS (120 V use only)					
Ampere rating		Total length in feet			
More than	Not more than	7.5 m (25')	15 m (50')	30 m (100')	45 m (150')
0	6	18	16	16	14
6	10	18	16	14	12
10	12	16	16	14	12
12	16	14	12	Not Applicable	

SYMBOLS

WARNING: Some of the following symbols may appear on the drill. Study these symbols and learn their meaning. Proper interpretation of these symbols will allow for more efficient and safer operation of this tool.

V	Volts
A	Amperes
Hz	Hertz
W	Watts
kW	Kilowatts
μF	Microfarads
L	Liters
kg	Kilograms
H	Hours
N/cm ²	Newtons per square centimeter
Pa	Pascals
OPM	Oscillations per minute
Min	Minutes
S	Seconds
 or a.c.	Alternating current
	3-Phase alternating current
	3-Phase alternating current with neutral

SYMBOLS (continued)

	Direct current
n_0	No load speed
	Alternating or direct current
	Class II construction
	Splash-proof construction
	Watertight construction
	Protective grounding at grounding terminal, Class I tools
.../min	Revolutions or reciprocations per minute
\emptyset	Diameter
0	Off position
	Directional arrow
	Warning symbol
	Wear your safety glasses
	Wear your hearing protection



Intertek
3042597
JD2025U

This symbol designates that this tool is listed with Canadian and U.S. requirements by ETL Testing Laboratories, Inc.

Conforms to UL Std. 60745-1, 60745-2-1, and 60745-2-2.

Certified to CAN/CSA Std.C22.2 No.60745-1, 60745-2-1 and 60745-2-2.

KNOW YOUR DRILL

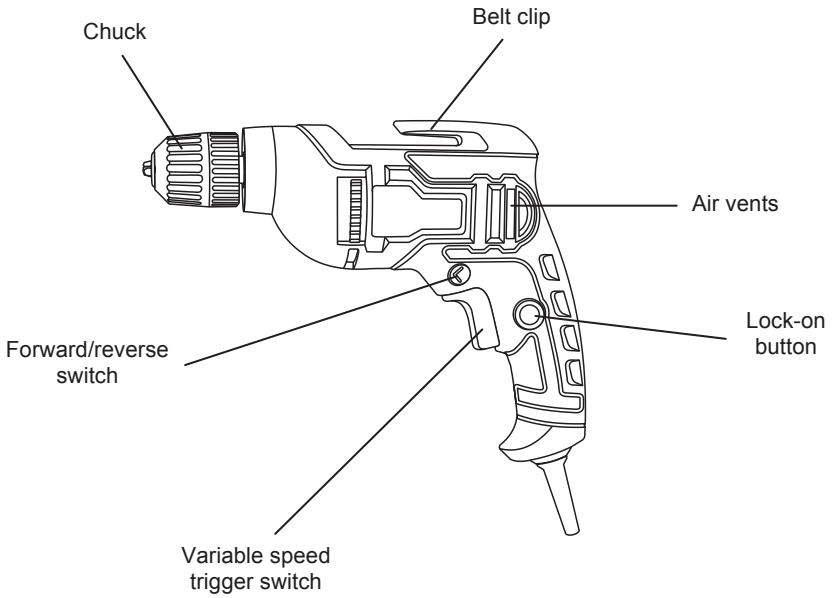

ASSEMBLY AND OPERATING

FORWARD/REVERSE SWITCH

The forward/reverse switch (1) is conveniently mounted above the trigger switch (2) (Fig. 1). To make the drill rotate clockwise for drilling, push the forward/reverse switch to the right. To make the drill rotate counter-clockwise, push the forward/reverse switch to the left.

NOTES:

- a) Never change the position of the forward/reverse switch while the chuck is turning.
- b) There is no dead center position for the forward/reverse switch. The tool will run only when it is in either the full left or full right position.

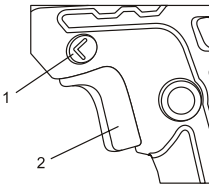

Fig. 1

VARIABLE-SPEED TRIGGER SWITCH

This drill is equipped with a variable-speed ON/OFF trigger switch.

1. To start drill, gently squeeze the trigger switch (2) (Fig. 2).
NOTE: The drill will turn at its slowest speed when the trigger switch is depressed slightly. The drill will turn at its fastest speed when the trigger switch is fully depressed.
2. To stop the drill, release the trigger switch.
NOTE: Drilling at a slow speed for an extended period of time may cause the drill motor to overheat. If drill gets hot, stop drilling and allow it to cool for at least 15 minutes.

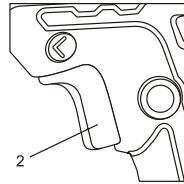

Fig. 2

INSTALLING DRILL BITS

WARNING: Never hold the chuck body with one hand and use the drill power to rotate the drill body to loosen or tighten bits. Serious injury may result

This drill is equipped with a keyless chuck.

This chuck is designed to provide easy two-handed tightening and loosening of the chuck jaws.

1. To open the keyless drill chuck, grasp and hold the chuck collar (1) with one hand (Fig. 3). Rotate the chuck body (2) in a counter-clockwise direction until the chuck jaws (3) open wide enough to accept the bit (4).
2. Insert the bit into the chuck the full length of the jaws or until the spiral portion of the bit is near the chuck jaws. Raise the front of your drill slightly to prevent the bit from falling out of the chuck jaws.
3. Tighten the chuck jaws onto the bit by turning the chuck body in a clockwise direction.

NOTE: Make sure the bit is properly aligned in the jaws and NOT at an angle. An improperly aligned bit could be thrown from the chuck when the drill is started

ASSEMBLY AND OPERATING (continued)

INSTALLING DRILL BITS – cont'd

4. Finish tightening the chuck jaws by holding the chuck collar with one hand and firmly tightening the chuck body by rotating it in a clockwise direction.

NOTE: Hand tighten the chuck jaws. Do NOT use pliers

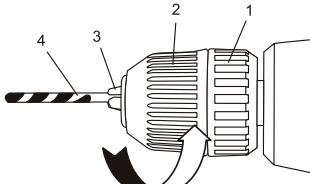

Fig. 3

WARNING: Do not insert the drill bit into the chuck and tighten as shown in Fig. 4. The drill bit **MUST** be properly inserted with all three of the chuck jaws holding the bit centered in the chuck. Failure to properly insert the drill bit could cause the drill bit to be thrown from the chuck, resulting in possible serious injury or damage to the chuck.

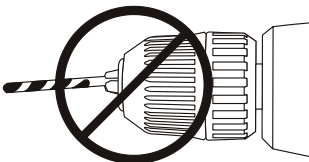

Fig. 4

REMOVING DRILL BITS

1. To open the keyless drill chuck, grasp and hold the chuck collar with one hand. Rotate the chuck body in a counter-clockwise direction until the chuck jaws open wide enough to release the bit.
2. Remove the bit.

TRIGGER SWITCH LOCK

The trigger switch lock-on feature allows the trigger switch to be locked in the ON position at full speed when continuous operation for extended periods of time is required (Fig. 5).

To lock the trigger switch in the ON position, pull back on the trigger switch to start the drill. Continue to squeeze the trigger until the drill reaches its maximum speed. Push the trigger switch lock button (3) into the drill handle. Release the trigger switch while holding the trigger switch lock button into the drill handle. The drill will continue to run at full speed. To release the trigger switch lock button, pull the trigger switch back and then release the trigger.

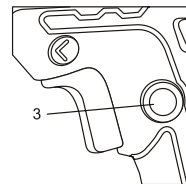

Fig. 5

ASSEMBLY AND OPERATING (continued)

WARNING:

For safety reasons, the operator must read the sections of this Owner's Manual entitled "GENERAL SAFETY WARNINGS", "POWER TOOL SAFETY", "SPECIFIC SAFETY RULES", "GUIDELINES FOR EXTENSION CORDS" and "SYMBOLS" before using this drill.

Verify the following every time the drill is used:

1. Safety glasses, safety goggles, or face shield is being worn.
2. Hearing protection and dust mask are being worn when drilling in concrete.
3. The chuck has not worked loose on the spindle.
4. The bit is in good condition, and is properly tightened into the chuck.

Failure to observe these safety rules will significantly increase the risk of injury.

DRILLING

When drilling into smooth, hard surfaces such as metal, use a center punch to mark the desired hole location. This will prevent the drill bit from slipping off center as the hole is started.

The workpiece to be drilled should be secured in a vice or with clamps to keep it from turning as the drill bit rotates (Fig. 6).

1. Check the drill bit to make sure it is firmly locked into the drill chuck, and verify that the forward/reverse switch is in the forward position.
2. Hold the drill firmly with both hands whenever possible. Use one hand to grasp the handle and switch.
NOTE: Make sure the hand placed on

the body of the drill does not cover the air vents. Covering these air vents will reduce motor cooling, and possibly lead to overheating the motor.

3. While holding the drill firmly, place the point of the drill bit at the point to be drilled.
4. Squeeze the switch trigger to start the drill.
NOTE: Always use a higher drill speed when drilling small holes. Use a slower drill speed when drilling large holes.
5. Move the drill bit into the workpiece applying only enough pressure to keep the bit cutting. Do not force the drill bit or apply sideways pressure to elongate the hole.

WARNING: Be prepared for binding and bit breakthrough. When these situations occur, the drill bit has a tendency to grab the workpiece. This action will kick the drill opposite to the direction of the drill bit rotation, and could cause loss of control when breaking through material as you complete drilling the hole. If you are not prepared, this loss of control can result in serious injury.

When drilling metals, use light oil on the drill bit to keep it from overheating. The oil will prolong the life of the drill bit and improve the cutting action. If the bit jams in the workpiece, or if the drill stalls, release the trigger switch immediately. Remove the bit from the workpiece and determine the reason for jamming.

ASSEMBLY AND OPERATING (continued)

DRILLING – cont'd

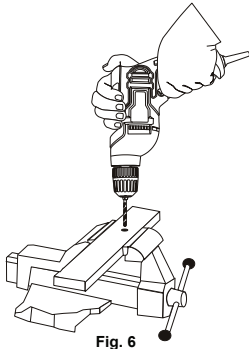



Fig. 6

- Remove the chuck screw using a #2  screwdriver (Fig. 8). **NOTE:** Turn the screw **CLOCKWISE** to remove it. This screw has a left-handed thread.

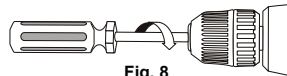

Fig. 8

- Insert the hex key into the chuck and tighten jaws of chuck securely (Fig. 9). Tap the hex key sharply with a mallet in a **COUNTER-CLOCKWISE** direction. This will loosen the chuck on the spindle. The chuck can now be unscrewed and removed from the spindle by hand.

REMOVING THE CHUCK

To remove the chuck:

- Remove the drill plug from the power source.
- Insert a $\frac{5}{16}$ " (8 mm) or larger hex key (1) into the chuck (2) and tighten the chuck jaws securely (Fig. 7). Make sure each of the chuck jaws (3) is seated on the flat surfaces of the hex key.
- Tap the hex key sharply with a mallet (4) in a clockwise direction. This action will loosen the screw in the chuck for easy removal.
- Open chuck jaws and remove the hex key.
- Open the chuck jaws as far as possible.

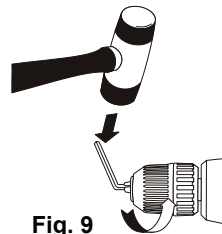

Fig. 9

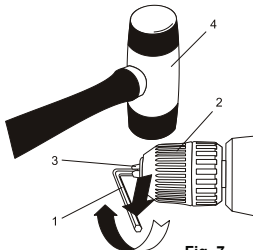



Fig. 7

ASSEMBLY AND OPERATING (continued)

RETIGHTENING A LOOSE CHUCK

After installing a chuck that has previously been removed, the chuck may become loose on the spindle and develop a wobble. Also, the chuck screw may become loose, causing the chuck jaws to bind and prevent them from closing. To tighten the chuck, follow these steps:

1. Insert the hex key into the chuck and tighten the chuck securely.
2. Tap the hex key sharply with a mallet in a **CLOCKWISE** direction (Fig. 10). This will tighten the chuck on the spindle.
3. Open the chuck jaws and remove the hex key.
4. Tighten the chuck screw using a #2  screwdriver.
NOTE: Turn the screw **COUNTER-CLOCKWISE** to tighten it. This screw has a left-handed thread.

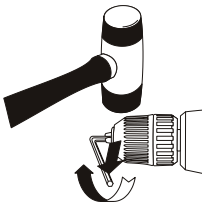

Fig. 10

MAINTENANCE

GENERAL

WARNING: When servicing this tool, use only identical replacement parts. The use of any other part may create a hazard or cause product damage

DO NOT use solvents when cleaning plastic parts. Plastics are susceptible to damage from various types of commercial solvents and may be damaged by their use. Use a clean cloth to remove dirt, dust, oil, grease etc.

WARNING: Do not allow brake fluids, gasoline, petroleum-based products, penetrating oils, etc. to come into contact with plastic parts. They contain chemicals that can damage, weaken or destroy plastic.

DO NOT abuse power tools. Abusive practices can damage the tool and the workpiece.

WARNING: DO NOT attempt to modify tools or create accessories. Any such alteration or modification is misuse and could result in a hazardous condition leading to possible serious injury. It will also void the warranty.

LUBRICATION

All of the bearings in this tool are lubricated with a sufficient amount of high-grade lubricant for the life of the unit under normal conditions. Therefore, no further lubrication is required.

EXPLODED VIEW

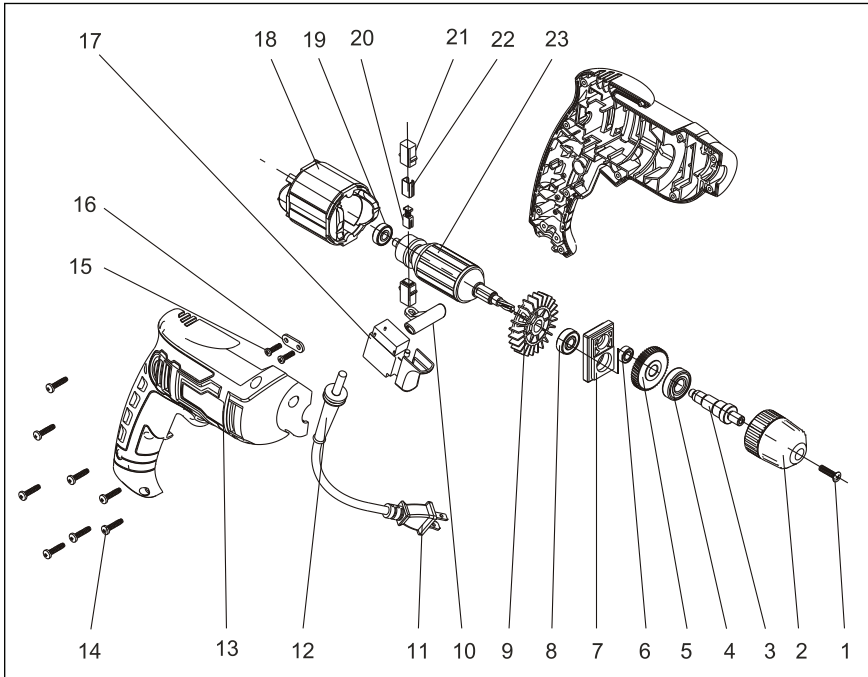

PARTS LIST

WARNING:

When servicing, use only original equipment replacement parts. The use of any other parts may create a safety hazard or cause damage to the drill.

Any attempt to repair or replace electrical parts on this drill may create a safety hazard unless repairs are performed by a qualified technician. For more information, call the Toll-free Help-line, at 1-866-349-8665 (Monday through Friday 9am – 5pm Eastern Time).

Always order by PART NUMBER, not by key number.

Key #	Part #	Part Name	Quantity
1	4020030001	Chuck screw	1
2	1140020006	³ / ₈ Chuck	1
3	2040040017	Shaft	1
4	4010010052	Bearing 6001RS	1
5	2010020001	Big gear	1
6	4010010061	Bearing 687RS	1
7	3150210005	Bearing seat	1
8	4010010048	Bearing 608 2RS	1
9	3150010085	Fan	1
10	3120030083	Forward / reverse button	1
11	1190030001	Cord set	1
12	3140010004	Cord guard	1
13	3011010019	Housing	1
14	4030010078	Screw	8
15	4030010074	Screw	4
16	2030050002	Strain relief	1
17	1061050001	Switch	1
18	1020010010	Stator	1
19	4010010034	Bearing 607-2Z	1
20	1230010101	Carbon brush	2
21	3150060002	Brush holder	2
22	2030070004	Copper crush holder	2
23	1010010012	Rotor	1

WARRANTY

RADLEY $\frac{3}{8}$ " DRILL WARRANTY

If this Radley Tool fails due to a defect in material or workmanship within one year from the date of purchase, return it to any Home Hardware store with the original bill of sale for exchange. This warranty does not include expendable parts including but not limited to blades, brushes, belts, light bulbs and/or batteries. This warranty covers defects in material or workmanship only. It does not cover normal wear and tear, failure due to abuse/misuse, or defects caused by careless or accidental mishandling. If this Radley product is used for commercial or rental purposes, this warranty does not apply.

Meet Radley

For long days on the job when you need a tool that can go the distance, this drill is your new best friend. You'll never worry about running out of juice with this corded $\frac{3}{8}$ " drill that has ample power, a keyless double sleeve chuck for easy bit changes and variable speeds including forward and reverse.



Radley®

EXCLUSIVE TO HOME HARDWARE

For information on the entire line-up of Radley power tools visit homehardware.ca or your local Home Hardware retail store.

MADE IN CHINA / FABRIQUÉ EN CHINE
HOME HARDWARE STORES LIMITED
ST. JACOBS, ONTARIO N0B 2N0
ORDER ONLINE / COMMANDE EN LIGNE
homehardware.ca

© 06 / 2018 Home Hardware Stores Limited



1240-055